

PHYSICS FOUNDATIONS SOCIETY  
THE FINNISH SOCIETY FOR NATURAL PHILOSOPHY



# THE SHORT HISTORY OF SCIENCE

– or the long path to the union of metaphysics and empiricism

Third, complemented edition

TUOMO SUNTOLA



PHYSICS FOUNDATIONS SOCIETY  
THE FINNISH SOCIETY FOR NATURAL PHILOSOPHY

# THE SHORT HISTORY OF SCIENCE

– or the long path to the union of metaphysics and empiricism

Third, complemented edition

TUOMO SUNTOLA

PHYSICS FOUNDATIONS SOCIETY  
THE FINNISH SOCIETY FOR NATURAL PHILOSOPHY

[www.physicsfoundations.org](http://www.physicsfoundations.org) / [www.lfs.fi](http://www.lfs.fi)

E-BOOK (PDF)

[Creative Commons Attribution-NonCommercial-NoDerivatives 4.0 International License](https://creativecommons.org/licenses/by-nc-nd/4.0/)



Cover: Thales (ca. 625–546 BC, *Wikimedia Commons*)

Pictures in Biography Gallery, *Wikimedia Commons*

Copyright © 2018 *Tuomo Suntola*.

ISBN 978-952-68101-6-4 (hardcover)

ISBN 978-952-68101-7-1 (PDF)

*To the great thinkers ... through times.*



# Contents

<b>PREFACE</b>	<b>11</b>
<b>INTRODUCTION</b>	<b>13</b>
<b>1. FROM ANTIQUE METAPHYSICS TO EMPIRICAL SCIENCE</b>	<b>17</b>
Antique inheritance	17
<i>The structure of the universe</i>	19
<i>The structure of matter</i>	24
<i>Toward the modern era</i>	27
From Copernicus's solar system to Newton's mechanics	29
<i>Newton and Principia</i>	43
<i>The velocity of light</i>	48
From Newtonian space to Einsteinian space	50
<i>Analytical mechanics</i>	51
<i>Thermodynamics and statistical mechanics</i>	55
<i>Electromagnetism and the theory of light</i>	57
From Maxwell's equations to the theory of relativity	65
From radiation quantum to quantum mechanics	78
From special relativity to general relativity and cosmology	87
<b>2. BASIC CONCEPTS</b>	<b>97</b>
<i>Postulates and definitions</i>	109
<i>Open questions</i>	111
<b>3. DYNAMIC UNIVERSE</b>	<b>113</b>
Unified expression of energy	113
<i>The concept of quantum</i>	125
Observations and the picture of reality	129
<i>Buildup of energy in Dynamic Universe</i>	129
<i>Expanding and non-expanding objects and systems</i>	130
<i>Development of the length of a day and a year</i>	131
<i>Observations of distant space</i>	133
<i>Local mass centers in space</i>	138
<i>Celestial mechanics, the perihelion advance</i>	141
<i>The frequency of atomic clocks on the Earth and in near space</i>	144
<b>4. EVALUATION OF THEORIES ON NATURAL SCIENCES</b>	<b>147</b>
<i>Theory structures</i>	148
<i>The principle of economy</i>	151

**APPENDIX I. BIOGRAPHY GALLERY****153**

Thales (c. 625–546 BC)	153
Anaksimander (c. 610–546 BC)	153
Anaximenes (c. 585–528 BC)	154
Pythagoras (c. 570–490 BC)	154
Heraclitus (c. 535–475 BC)	155
Parmenides (c. 510 BC)	156
Anaxagoras (c. 500–428 BC)	156
Empedocles (c. 492–432 BC)	157
Philolaus (c. 470–385 BC)	157
Leucippus (400s BC)	158
Democritus (c. 460–370 BC)	158
Plato (424–348 BC)	159
Eudoxus (c. 408–355 BC)	160
Heraclides (c. 387–312 BC)	160
Aristotle (384–322 BC)	161
Euclid (c. 350–280 BC)	162
Epicurus (341–270 BC)	162
Aristarchus (310–230 BC)	163
Archimedes (c. 287–212 BC)	164
Eratosthenes (276–194 BC)	164
Apollonius (noin 262–190 eKr.)	165
Hipparchus (c. 190–120 BC)	165
Seleukos (noin 190–150 eKr.)	166
Klaudios Ptolemaios (noin 85–165 jKr.)	166
John Philoponus (490–570)	167
Jean Buridan (c. 1300–1360)	167
Ibn al-Shatir (1304–1375)	168
Nicolaus Copernicus (1473–1543)	169
Sir Thomas Digges (1546–1595)	171
Tyko Brahe (1546–1601)	172
Giordano Bruno (1548–1600)	173
Francis Bacon (1561–1626)	173
Galileo Galilei (1564–1642)	174
Johannes Kepler (1571–1630)	175
Thomas Hobbes (1588–1679)	177
René Descartes (1596–1650)	177
Pierre de Fermat (1601–1665)	178
Ismael Boulliau (1605–1694)	179
John Wallis (1616–1703)	179



---

Blaise Pascal (1623–1662)	180
Giovanni Cassini (1625–1712)	181
Robert Boyle (1627–1691)	181
Christiaan Huygens (1629–1695)	182
Christopher Wren (1632–1723)	183
Robert Hooke (1635–1703)	184
Isaac Newton (1643–1727)	186
Ole Römer (1644–1710)	188
Gottfried Leibniz (1646–1716)	188
Edmond Halley (1656–1742)	191
James Bradley (1693–1762)	192
Pierre Louis Maupertuis (1698–1759)	192
Daniel Bernoulli (1700–1782)	193
Benjamin Franklin (1706–1790)	193
Leonhard Euler (1707–1783)	194
Jean le Rond d'Alembert (1717–1783)	195
Immanuel Kant (1724–1804)	195
Henry Cavendish (1731–1810)	196
Joseph Priestley (1733–1804)	197
Joseph Louis Lagrange (1736–1813)	197
Charles-Augustin de Coulomb (1736–1806)	198
William Herschel (1738–1822)	199
Antoine Lavoisier (1743–1794)	199
Alessandro Volta (1745–1827)	200
Jean Delambre (1749–1822)	200
Pierre-Simon Laplace (1749–1827)	201
Adrien-Marie Legendre (1752–1833)	202
John Dalton (1766–1844)	203
Joseph Fourier (1768–1830)	204
Thomas Young (1773–1829)	204
André-Marie Ampère (1775–1836)	205
Amedeo Avogadro (1776–1856)	206
Hans Christian Ørsted (1777–1851)	207
Carl Friedrich Gauss (1777–1855)	207
Siméon Denis Poisson (1781–1840)	208
François Arago (1786–1853)	209
Augustin-Jean Fresnel (1788–1827)	209
Georg Simon Ohm (1789–1854)	211
Michael Faraday (1791–1867)	211
Gustave Coriolis (1792–1843)	213

Sadi Carnot (1796–1832)	214
Benoît Paul Émile Clapeyron (1799–1864)	214
Christian Doppler (1803–1853)	215
Wilhelm Eduard Weber (1804–1891)	215
William Hamilton (1805–1865)	217
Julius von Mayer (1814–1878)	217
James Joule (1818–1889)	218
Léon Foucault (1819–1868)	219
Hippolyte Fizeau (1819–1896)	220
George Stokes (1819–1903)	220
Hermann von Helmholtz (1821–1894)	221
Rudolf Clausius (1822–1888)	222
William Thomson (1824–1907)	223
George Stoney (1826–1911)	224
James Clerk Maxwell (1831–1879)	225
Ernst Mach (1838–1916)	227
Josiah Willard Gibbs (1839–1903)	227
Ludwig Boltzmann (1844–1906)	228
Woldemar Voigt (1850–1919)	229
Oliver Heaviside (1850–1925)	229
George FitzGerald (1851–1901)	230
John Henry Poynting (1852–1914)	230
Albert Abraham Michelson (1852–1931)	231
Hendrik Lorentz (1853–1928)	232
Henri Poincaré (1854–1912)	233
Johannes Robert Rydberg (1854–1919),	234
Joseph John Thomson (1856–1940)	235
Heinrich Rudolf Hertz (1857–1894)	236
Joseph Larmor (1857–1942)	236
Max Karl Ernst Ludwig Planck (1858–1947)	237
Philipp Lenard (1862–1947)	238
Wilhelm Wien (1864–1928)	238
Hermann Minkowski (1864–1909)	239
Robert Millikan (1868–1953)	239
Arnold Sommerfeld (1868–1951)	240
Ernest Rutherford (1871–1937)	241
Walter Kaufmann (1871–1947)	241
Willem de Sitter (1872–1934)	242
Karl Schwarzschild (1873–1916)	243
Albert Einstein (1879–1955)	244

---

Richard Tolman (1881–1948)	246
Max Born (1882–1970)	247
Niels Henrik David Bohr (1885–1962)	248
Erwin Schrödinger (1887–1961)	248
Alexander Friedmann (1888–1925)	249
Edwin Powell Hubble (1889–1953)	249
Louis de Broglie (1892–1987)	250
Arthur Compton (1892–1962)	251
Georges Lemaitre (1894–1966)	251
Werner Heisenberg (1901–1976)	252
Paul Dirac (1902–1984)	253
Howard Robertson (1903–1961)	253
George Gamov (1904–1968)	254
Arthur Geoffrey Walker (1909–2001)	254
David Bohm (1917–1992)	255
Richard Feynman (1918–1988)	255



## Preface

This book reviews the development of the natural sciences and the picture of reality produced by science from the philosophical conceptions in antique metaphysics to the picture outlined from the mathematical models produced by empirical research in modern physics. Also, the book studies the possibility of a re-evaluation of the picture of reality from a holistic perspective with a closer connection between philosophical and empirical aspects.

The perspective and background of the review evolve from the writer's several decades of work on the Dynamic Universe. The work emphasizes the philosophical and metaphysical aspects with simple postulates, a holistic view of observations, and clear logic and mathematical description with precise correspondence to observations.

The history of science shows that most part of the development has occurred in small steps. Typically, geniuses behind major steps or revolutions in science have been able to combine observations and ideas made in different areas of physics. Newtonian mechanics, which give the directions to the development of physical sciences in the modern era, combined the idea of the Copernican solar system, Kepler's planetary orbits based on Tycho Brahe's precise observations, Galileo Galilei's experimental results, the concepts of momentum by René Descartes and Christiaan Huygens and the conceptions of calculus by Pierre de Fermat and John Wallis. The Principia by Isaac Newton triggered a phenomenal development of mathematics in the 1700's – maybe partly at the cost of physics; for example, the analytical mechanics by Lagrange and the potential theory by Laplace were primarily mathematical considerations which, however, turned out to serve as useful tools in the later identification of the conservation of energy as a primary law of nature. The concept of energy as work, integrated force and a unifying quantity in physics in different sub-areas, was completed first in thermodynamics, chemistry, and electromagnetism.

Maxwell's success in the formulation of his famous equations was based on his deep perception of the basic laws of nature and his ability to combine that with the vast experimental understanding of electromagnetic phenomena that had been gathered in numerous experiments during the preceding fifty years.

The special theory of relativity would not have been possible without a wide range of experiments, observation, conclusions and mathematical analyses by many ingenious scientists in the late 1800's. Outlining of quantum mechanics in the early 20<sup>th</sup> century was induced by the interpretations of the Planck equation, the Einsteinian photoelectric effect and Bohr's atomic model. The principles of quantum mechanics, however, were established first after many experimental and theoretical considerations.

The general theory of relativity equated gravitational acceleration and the inertial acceleration given by the special theory of relativity. As a result, gravitation was described in terms of the geometry of curved spacetime. The cosmological model

derived from the general theory of relativity also relies on results in special relativity and quantum mechanics.

The history of science presented in this book is restricted to physics, astronomy, and cosmology with the emphasis on issues that I have seen important for the buildup and re-evaluation of the scientific picture of reality. Due to the development history, theories in the sub-areas have been based on postulates that are partly conflicting. The diversity of postulates restricts the possibilities of unifying today's theories. The re-evaluation presented in this book is based on a study of the universe as an energy system where local systems are linked to the whole and thereby to each other under the same universal laws of nature and postulates in common.

With this book, I want to express my deep respect to all scientists and thinkers throughout written history, who have worked on the progress of science and the buildup of a picture of reality – to those mentioned by name in this book and equally to the many individuals whose contribution is invisible or indirectly accounted. New findings integrate discoverers' views or perspectives into all the experience and information gathered before them. History also shows that inspiring teachers and tutors have been of crucial importance to the achievements of many celebrated scientists.

I express my gratitude and appreciation for the free availability of information opened through the Internet by public institutions and voluntary organizations. The availability of original writings and articles has been of special value. I have supplied the electronic version of the book with links, which give the reader direct access to the sources used and to additional information. Most of the links have been gathered into the gallery of Appendix I. Pictures in the book comprise my own drawings and pictures freely available in *Wikimedia Commons*.

In the third edition Chapters 2-4 have been rewritten into a more readable form. The www-links have been updated, thanks to my granddaughter Senja.

I am grateful to my colleagues in the Physics Foundations Society, Tarja Kallio-Tamminen, Ari Lehto and Heikki Sipilä, for inspiring discussions and profound insights and to the members of the Finnish Society for Natural Philosophy who participated in many illuminating discussions participated in many insightful discussions. My warm thanks go to my wife Soilikki and my daughter Silja and her family for their continuous support and encouragement of my endeavor.

## Introduction

The purpose of this treatise is to trace the paths to the currently predominating theories and the related picture of reality in natural sciences – and to study the realized and unrealized union of natural philosophy and empiricism. The start of the path studied is traced to Thales (c. 625–546 BC), who is generally regarded as the grandfather of the scientific tradition in western culture. Of the high number of scientists since Thales’s time, fewer than one hundred and fifty have been included in this book – about twenty from antiquity, another twenty prior to the Copernican – Newtonian revolution about 1500 years later and the remaining one hundred more or less uniformly from the 1700’s to the inception of present theories in the early 1900’s.

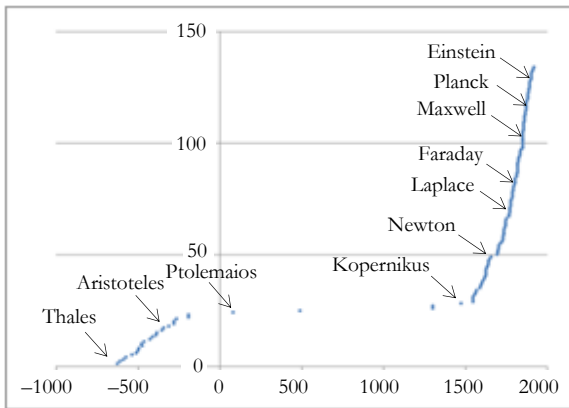

The cumulating group of people with a major contribution to the development of natural sciences since 600’s BC to early 1900’s ordered by the year of birth. (Appendix I, Gallery).

The active antique era was followed by about 1500 years of cessation, with practically zero progress in science. The development toward modern mathematical physics and empirical science was triggered by Newton’s *Principia* in the late 1600’s preceded by the Copernican revolution.

Antique science was concentrated in the philosophy of basic principles – empirical science was restricted mainly to astronomy that produced models for describing the motions of celestial bodies.

Motions of celestial bodies were more or less independent of the “earthly” physical phenomena described by Aristotle’s laws of motion. The concept of matter was restricted to a qualitative description of the properties of matter. Ideas about the structure of matter were divided between the concept of a continuous substance of everything and the idea of more or less independent undivided atoms.

At a philosophical level, the antique heritage was important; continuity, the cross-linkage of everything, cause and effect, natural balance and harmony as well as the mathematical beauty were understood as fundamental principles in nature. The goal of science was understood as the challenge of making nature understandable. Aristotle claimed that a successful theory should be based on fundamental principles with a minimum amount of additional postulates.

The philosophical approach and the fundamental principles were not, however, enough to reach the goals of science; antique metaphysics had to wait for more than 1500 years before getting completed with an empirical approach with advanced instruments and developed mathematical methods. Newton's *Principia* triggered the development of mathematical physics. One of the key factors was the linkage of celestial mechanics and the laws of motion. The laws of motion required definitions for inertial force and mass; the linkage to celestial mechanics was then based on the equivalence of inertial force and the gravitational force as a centripetal force toward a mass. The huge progress in mathematics in the 1700's completed the success of Newtonian mechanics, and the picture of the world seemed completed in the early 1800's.

Application of the laws of motion requires the definition of the state of rest. In spite of the fact that Newton's celestial mechanics assumed fixing of the coordinate system to the distant stars representing the global state of rest, the laws of motion could be equally applied in coordinate systems fixed to a state of rest on the orbiting and rotating Earth – as well as in systems in linear motion relative to a state of rest on the Earth. This meant that the status of being in a state of rest appeared a non-exclusive property, which established the status of Galileo Galilei's relativity principle as a law of nature.

Observations on electromagnetic phenomena in the early 1800's, meant a major accession to the almost established picture of reality. Mathematical description of electromagnetism required the conception of new quantities and re-evaluation of the laws of mechanics. A solution was found from the concept of energy, which was hidden in the concept of living force, *vis viva*, introduced by Newton's contemporary Gottfried Leibniz. When formulating the observed characteristics of electricity and magnetism into a comprehensive mathematical model, James Maxwell created a mechanical analog of the interaction between potential energy and the energy of motion, which made it possible to express the functions of a harmonic oscillator and propagating wave in terms of electrical quantities. In mechanics, energy was recognized as work and the integrated force, and the primary conservable in closed systems. Importantly, the concept of energy created a bridge between electromagnetic, mechanical, chemical, and thermodynamic systems.

Electromagnetic radiation, and especially, the propagation velocity of radiation created new problems. Observations on electromagnetic phenomena seemed to follow the classical relativity principle but infringe the linear Galilean transformation behind the relativity principle. The relativity principle was saved by redefining the coordinate quantities, time and distance, as functions of the velocity, and later on of the gravitational state between the object and the observer. Such a redefinition made the Galilean transformation nonlinear but allowed local phenomena to look the same for any observer.

Another type of problem in the classical picture of reality arose from the behavior of atomic phenomena. The continuity of physical quantities like location, velocity, and energy was threatened. Further, the difference between quantities like particles and waves was blurred; particles showed wavelike properties and waves particle-like properties. The description of atomic phenomena was separated into quantum



mechanics with its specific postulates. Quantum mechanics proved to be a powerful formalism, with the capability of precise predictions of phenomena observed and to be observed; the price of the success was a further confusion of the picture of reality already dimmed by the theory of relativity.

In this book, the re-establishment of a common basis for the theory structures and the huge amount of observational facts produced by empirical science is studied from the perspective of an overall energy principle. We can recognize the finiteness of total energy as the natural basis behind relativity. In an overall energy approach, the energy that objects bind into motion or local gravitation in space reduces the energy available for internal processes within the objects; an atomic clock in motion or in the vicinity of a mass center runs slower because part of its energy is bound to the motion and local gravitation – not because the motion relative to an observer or local gravitation slows the flow of time as concluded from the kinematical approach behind the theory of relativity. In an energy analysis, the energy states in space can be described in terms of a system of nested energy frames. In such a structure we can recognize the characteristics of both a global and a local state of rest. Mass in the energy analysis is recognized as a wavelike substance for the expression of energy and a mass object a resonant mass wave structure.

In a historical perspective, the energy approach can be seen to honor the most profound scientific methods and principles comprising intuitive conception, empirical facts, and precise mathematical formulations – on the path to close the circle of philosophy, logic, and observations by relying on underlying universal laws of nature.



# 1. From antique metaphysics to empirical science

## Antique inheritance

Primarily, antique metaphysics meant contemplation of basic principles. The central topics were the creation of the world, fundamental substances, and the order behind everything in nature. Creation was strongly linked to religious views; the harmony and order seen in structures and phenomena were considered as manifestations of the laws of nature which could be opened to human conception in mathematics, geometry and music. The center of the antique world was the Earth surrounded by circles of the Sun, the Moon, the planets and the fixed stars.

The antique inheritance to natural sciences is in great part contained within Aristotle's *Metaphysics*<sup>1,2</sup> and *Physics*<sup>3</sup> culminating in the philosophical ideas of natural philosophy in the preceding two centuries. Aristotle starts his book *Metaphysics* with the statement: "*ALL men by nature desire to know*". Aristotle sees that the goal of science is to obtain wisdom which requires understanding of the first causes and principles, "*...the point of our present discussion is this, that all men suppose what is called Wisdom to deal with the first causes and the principles of things...*".

Aristotle defines the criteria of sciences, "*... and the most exact of the sciences are those which deal most with first principles; for those which involve fewer principles are more exact than those which involve additional principles, for example, arithmetic and geometry...*". Aristotle thought that an effect is related to its cause via causality; actuality is preceded by potentiality.

Figure 1-1 outlines the development paths of physical thinking for eight centuries, from 600 BC to 200 AD. The background arrows in the picture give a rough idea of the diversification of astronomy, the study of motion, and the description of material as their own branches of the natural sciences.

The roots of western natural sciences are generally dated back to Thales, who was a statesman, philosopher, engineer, mathematician, astronomer, and cosmologist. Thales attempted to remove natural sciences from their mythological origin and tried to find logical explanations to natural phenomena. He related the first cause behind the observable world to the ultimate principle, *arche*, which served as the basic substance and provided the characteristic features for all material forms and expressions. Thales saw water as the primary expression of *arche*, accordingly, he saw all other materials as derivatives of water. Thales's universe was Earth-centered: stars, planets, the Sun, and the Moon rotated the flat Earth floating on water.

---

<sup>1</sup> *Metaphysics of Aristotle* by T. Taylor (1801), [openlibrary.org](https://openlibrary.org)

<sup>2</sup> *Metaphysics by Aristotle*, Translated by W. D. Ross, The Internet Classics Archive

<sup>3</sup> *Physics by Aristotle*, Translated by W. D. Ross, The Internet Classics Archive

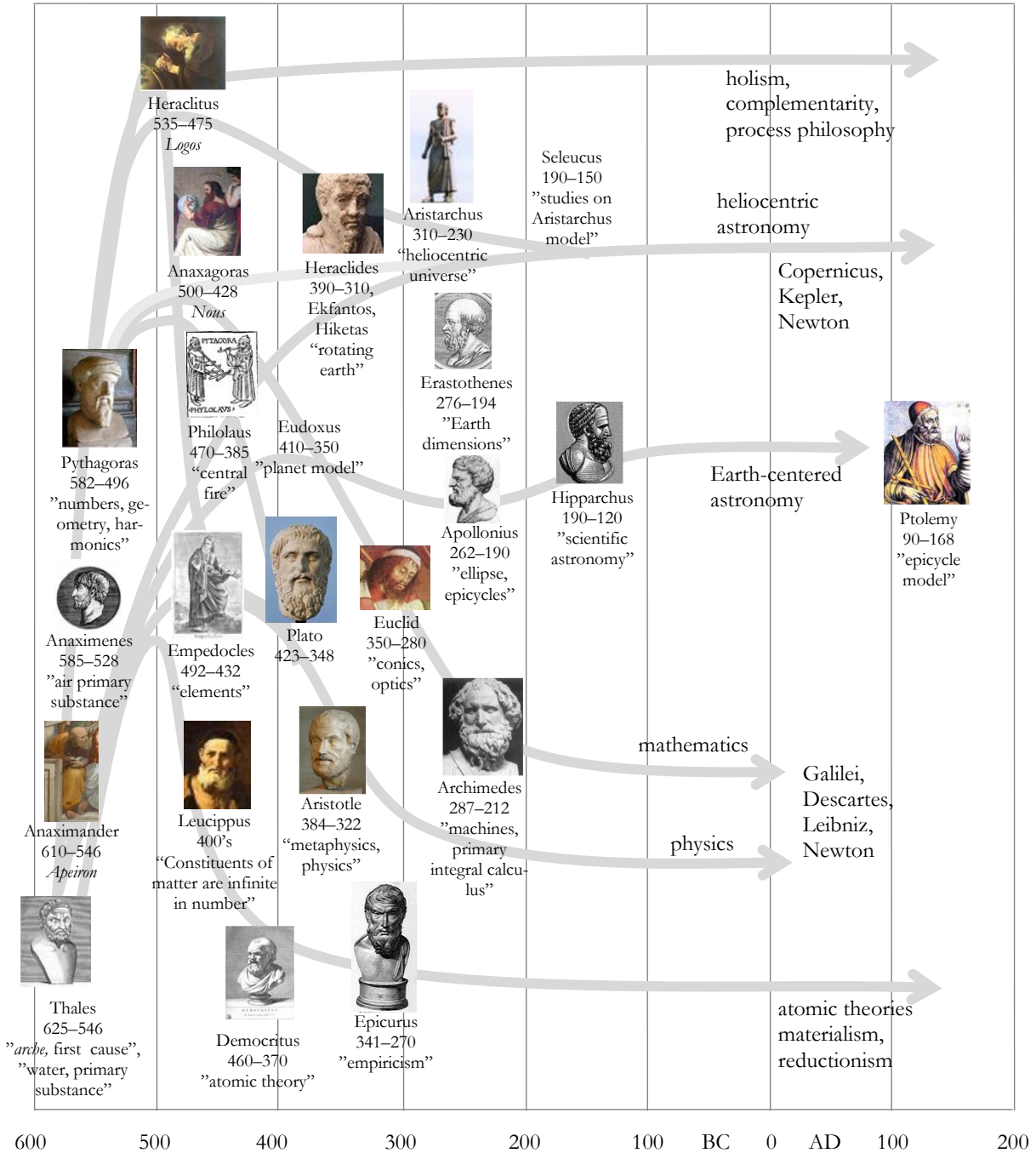

Figure 1-1. Antique philosophers and scientists, and the paths to the diversification of natural sciences.

## The structure of the universe

### *The development of the Earth-centered model*

The “antique official picture” of the observable universe remained Earth-centered from Thales to Ptolemy. The first known model of the skies was presented by Thales’s student Anaximander. He rejected Thales’s idea of the Earth as a floating disk on water, and let the Earth float free in the center of infinite space thus allowing full 360 degree orbits to celestial bodies. The sphere closest to the Earth hosted both the fixed stars and the planets. Next to the stars were the wheels for the Moon and the Sun, which followed the annual seasons by moving in the south-north direction in cylindrical symmetry, Figure 1-2.

In Anaximander’s model, fixed stars and planets were placed on the same sphere. Planets were called “wanderers” (*Greek "aster planetes", wandering star*) because of their irregular motion compared to the uniform rotation of the fixed stars. For a long time Venus, which was observed in the vicinity of the Sun, both in the morning and in the evening, was interpreted as two different stars – the morning star and the evening star. When Pythagoras described the Earth as a sphere instead of a disk, the morning star and the evening star were identified as the same planet.

Anaximander’s universe had spherical symmetry regarding stars and planets, but cylindrical symmetry regarding the Sun and the Moon. He did not explain the wandering of the planets. Compared to the radius of the disk-like Earth, the radius of the lunar wheel was 18-fold and the solar wheel about 27-fold.

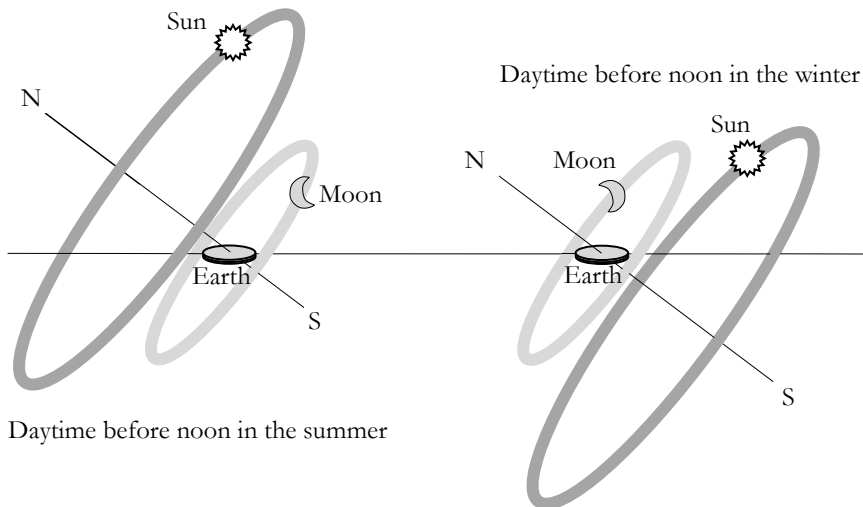

Figure 1-2. Anaximander’s universe was constructed of a flat Earth surrounded by the sphere of fixed stars and planets (not in the picture). The wheels for the Moon and the Sun were behind the sphere of stars. Annual change of the seasons was explained by motion of the solar wheel in the direction of the south-north axis.

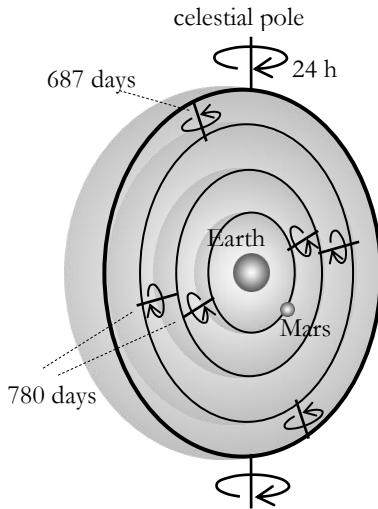

Figure 1-3. Eudoxus's model for planet Mars consisted of several spheres with Earth in the center. The rotation of the outmost sphere gave the daily motion of the planet. The next sphere gives the motion of the planet through the zodiac. The third and the fourth sphere together give the retrogradation with reversed orbital direction.

About 200 years later, Plato's student Eudoxus developed a planetary model based on homocentric spheres around the Earth. Each sphere had a specific rotation speed and axis direction, Figure 1-3. Each planet needed its own set of spheres. Fixed stars were placed on their own sphere. The spherical symmetry reflected the Pythagorean philosophy of perfect forms. There are no original documents of Eudoxus; his work appears in Aristotle's *Metaphysics*<sup>4</sup> (part XII, 8). In its original form Eudoxus's model consisted of 27 planetary spheres and one sphere for fixed stars. In the 4<sup>th</sup> century BC, the model was completed by Callippus, who increased the number of planetary spheres to 34. Eudoxus's model gave a reasonable description of the planetary motions, but due to the spherical symmetry, it did not explain the variations of the brightnesses which are due to the variation of the distances to the Earth.

In the 3<sup>rd</sup> century BC, the mathematician and astronomer Apollonius introduced the idea of epicycles for the description of eccentric orbits. A completed epicyclic model for the planets was presented by Ptolemy in the 2<sup>nd</sup> century AD.

The epicyclic model is an Earth centered system with both the Sun and the Moon orbiting the Earth. The precise center of the orbits is not the center of the Earth but a point outside the Earth. Opposite to the Earth, on the other side of the center was a point called equant. The basic orbit of epicycles was called deferent; epicycles move along the deferent with a constant angular velocity relative to the equant. The epicycle model was able to describe the apparent change in the orbital direction observed in the outer planets due to the orbital motion of the Earth, Figure 1-4.

In its final form, as presented by Ptolemy in his work *Mathematike Syntesis* in about 150 AD, the epicyclic model dominated over the planetary model for about 1500 years. *Mathematike Syntesis* was a comprehensive summary of antique astronomy and mathematics. The book is better known with its Arabic name *Almagest*<sup>5</sup>.

<sup>4</sup> Aristoteles, *Metaphysics*

<sup>5</sup> Richard Fitzpatrick, A Modern Almagest, <http://farside.ph.utexas.edu/Books/Syntaxis/Almagest.pdf>

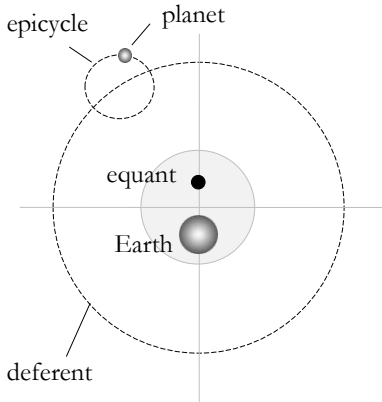

Figure 1-4. The structure of the epicyclic system. The planetary motion is determined by the orbiting motion of an epicycle, which moves along the deferent at a constant angular velocity relative to the equant. The center of the equant is not the Earth but a point midway between the Earth and the equant.

With its thirteen parts the *Almagest* served as the basic and most reliable guide for Islamic and European astronomers until the late 16<sup>th</sup> century when Tycho Brahe, based on his precise observations, found some systematic errors in *Almagest*'s tables.

#### *Questioning of the Earth-centered system*

Pythagoras, the father of antique mathematics and geometry, is assumed to have adopted Anaximander's picture of the cosmos. Pythagoras's contribution to the development of the cosmological picture, however, is unclear. His conviction was that the principles of mathematics were principles behind everything in nature. Mathematical relations were closely connected to music; in the motions of celestial bodies Pythagoras saw "*the symphony of spheres*". He assumed that the Earth was spherical and noticed that the orbit of the Moon was inclined to the equatorial plane of the Earth. Also, he was among the first who realized that the morning star is the same Venus as the evening star.

Pythagorean philosopher and polymath scientist, Philolaus, who lived in the 5<sup>th</sup> century BC in Croton in southern Italy was perhaps the first to challenge the Earth-centered universe with an alternative model. In Philolaus's model, the center of the universe was occupied by Central Fire as the primary source for all light in space. Celestial bodies including the Sun and the Earth revolved around the Central Fire; the light of the Sun was reflection from the Central Fire.

In Philolaus's model, celestial bodies were placed in ten spheres around the Central Fire<sup>6</sup>. The outmost sphere was occupied by fixed stars, the next five spheres by the known planets, the next three by the Sun, the Moon and the Earth. The innermost sphere was reserved for "Counter Earth" that counterbalanced the system relative to the Central Fire. The inhabited side of the Earth pointed outwards from the Central Fire. The model described basic observations with simple spheres and rotational motions, but it failed in explaining the irregularities in planetary motions, Figure 1-5.

<sup>6</sup> [Stanford Encyclopedia of Philosophy, Philolaus](#)

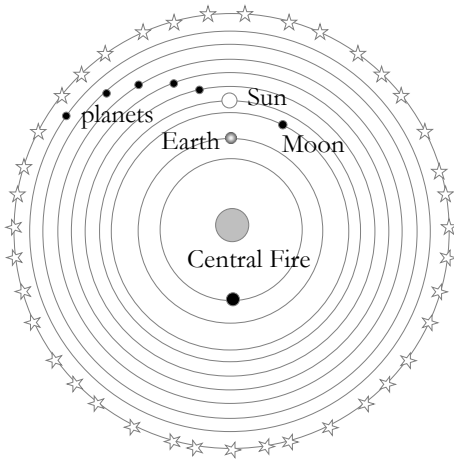

The Earth and the Sun at noon

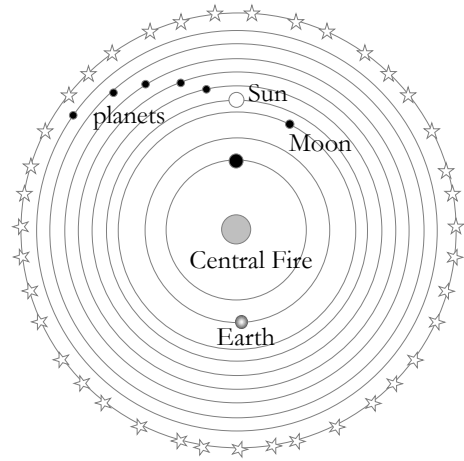

The Earth and the Sun at

Figure 1-5. Philolaus's model was based on Central Fire as the center of the universe. Celestial bodies including the Sun, the Moon, and the Earth rotated the Central Fire on the spheres. The innermost sphere was reserved to Counter Earth counterbalancing the system relative to the Central fire. All the time, the inhabited side of the Earth was facing outward from the Central Fire. The Earth revolves around the Central Fire once a day, the Moon once a month, and the Sun once a year. Each planet revolves around the Central Fire according to their annual period.

Philolaus's estimate for the length of the month was  $29\frac{1}{2}$  days (the precise value is 29.53 days) and for the length of a year  $365\frac{1}{2}$  days (the precise value is 365.2564 days).

Also, Democritus, who is better known for his contribution to atomism, questioned the status of the Earth as the eternal, static center of the universe. He saw the motions of the celestial bodies, including the Earth, as consequences and a continuation of atomic collisions arising in chaos and proceeding towards an end. He considered the possibility of many worlds that are created, decayed or destroyed by collisions to one another. Democritus realized that the Milky Way consists of distant stars which may be inhabited like the Earth.

In the 4<sup>th</sup> century BC, the idea of a static Earth was also questioned by the Pythagorean philosopher and member of the Platonic Academy, Heraclides. He suggested that the daily motion of celestial bodies is due to the rotation of the Earth around its axis once a day. Also, he realized that, at least, Mercury and Venus revolve around the Sun, Figure 1-6.

According to Archimedes (287–212 BC), his tutor Aristarchus had realized the heliocentric alternative. Aristarchus saw the Sun as the rotational center for all planets including the Earth, and followed Heraclides and the Pythagorean Hicetas (about 400–335 BC) in their idea of the rotating Earth for explaining the variations of day and night.



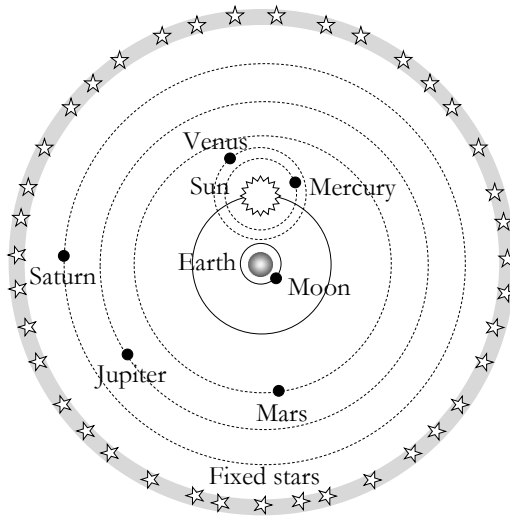

Figure 1-6. Heraclides is supposed to have proposed that Mercury and Venus revolve around the Sun, which revolved around the Earth together with the outer planets, Mars, Jupiter and Saturn. The daily rotation of the skies he explained with the rotation of the Earth, which allowed a static sphere for the fixed stars.

In Aristarchus's model, for explaining the annual seasons, the rotational axis of the Earth was inclined relative to the ecliptic plane. All the planets known at Aristarchus's time were placed on their orbits in correct order; Mercury, Venus, Earth, Mars, Jupiter, and Saturn.

Aristarchus's idea of the heliocentric system did not get support from his contemporaries. His model was also rejected by Hipparchus (about 190–120 BC), the father of systematic astronomy. Seleucus of Seleucia, contemporary to Hipparchus, however, supported the heliocentric model and suggested infinite space.

Aristarchus's writings on the heliocentric system have not survived to posterity. His works are mainly known via Archimedes's notes and the writings opposing his model. Aristarchus's book on astronomic measurements, however, has survived. In the book he describes measurements for determining the sizes and the distances of the Moon and the Sun. The measurements were not a part of his work on the heliocentric model. He determined the ratio between the distances to the Moon and to the Sun by measuring the angle between the Moon and the Sun at the time of half moon. Because the angular size of the Sun and the Moon are about the same, he concluded that the sizes of the two objects are related in the same way as their distances from the Earth, Figure 1-7.

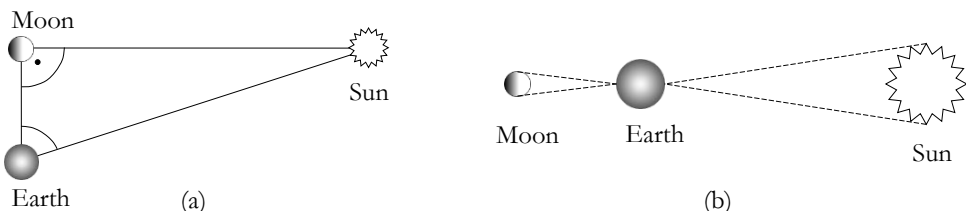

Figure 1-7. (a) By measuring the angle between the Moon and the Sun at the time of half moon, Aristarchus estimated that the ratio of the distances to the two objects is about 1:19 (the correct value of the ratio is about 1:400). (b) Because the angular size of the Sun and the Moon are about the same, he concluded that the diameter of the Sun is 19 times the diameter of the Moon.

## The structure of matter

Anaximander did not accept his tutor Thales's idea of water as the primary substance for all materials. Anaximander defined *Apeiron* as an abstract endless, unlimited principle and primary substance for all material expressions. *Apeiron* had no beginning or end. As a structureless substance, *Apeiron* was not linked to any known material. *Apeiron* created opposites or complementary pairs like cold – hot, and dry – wet, which probably included the idea of perception via differences. Anaximander's contemplations about the dualistic or complementary nature of finite and infinite may also be interpreted as a support for the idea of perception via differences.

Anaximander's student Anaximenes reverted to his elder tutor Thales's idea of a known material as the primary substance. Instead of water, Anaximenes chose air as the primary substance, for example, he explained soil as condensed air. In accordance with the prevailing Earth-centered world picture he thought that stars are formed of air vaporized from the Earth and flashed into fireballs due to their fast motion with their celestial sphere. Anaximenes explained earthquakes as consequences of excessive drying or the lack of moisture, lightning as a consequence of violent separation of clouds by stormy winds – rainbows were formed by sunlight hitting condensed air.

Heraclitus of Ephesus (about 535–475 BC) saw *Logos* as a universal law behind everything. He criticized his Ionian predecessors Thales, Anaximander, and Anaximenes for their way of describing phenomena as static and discrete. Heraclitus saw that all natural phenomena undergo a continuous change, and get their manifestations via the harmony of opposites or complementarity.

In a historical perspective, Heraclitus may be seen as the father of process philosophy as well as a pioneer of a holistic view of nature and world picture.

An early description of the material world was also presented by Anaxagoras (about 500–428 BC). According to Anaxagoras's concept, the visible world and all the material structures and living creatures it contains, are created of endless material substance by a non-personalized god as an ordering force. He called the ordering force or god by the name *Nous* (mind), which was separate from matter. Anaxagoras's *Nous* may be seen comprising certain properties of both Anaximander's *Apeiron* and Heraclitus's *Logos*. Anaxagoras's material consisted of subtle texture or divisions with knowledge and substance for all materials and forms of life.

### *Atomism*

The roots of atomism can be seen in the elementary divisions of Anaxagoras's material. Atomists turned the approach upside down; material was obtained via concentration of atoms. Atoms, as described by Leucippus, Democritus, and Epicurus, were independent particles – interaction between atoms was mechanical by its nature. The atom hypothesis can be seen as a precursor to a gradual change from the holistic thinking typical to pre-Socratic philosophers toward empirical sciences with emphasis on direct observations. Such a change removed science from religion and directed metaphysics toward materialism thus creating some early foundations to a

reductionistic world picture. Both Plato and Aristotle opposed atomism and the related materialistic direction, which, instead of first cause, stressed the description of observations. Observation of atoms, however, had to wait for more than 2000 years, and also the atomic theory as a scientific doctrine had to wait until the early 20<sup>th</sup> century AD.

### *Aristotle's metaphysics*

The most complete collection of the principles of antique physics is Aristotle's *Metaphysics*<sup>7</sup>. Practical physics, like the laws of motion, is presented in *Physics*<sup>8</sup>. It is essential for Aristotle's status as the authority of antique sciences that his large written production has survived for the future generations. In his *Metaphysics* Aristotle made many comments on his predecessors' ideas, for example, stating that the early philosophers concentrated primarily on the origin and the nature of material. They concluded that the primary form of material is eternal, it has never been created and it will never be destroyed.

*"Thales, the founder of this type of philosophy, says the principle is water ... It may perhaps be uncertain whether this opinion about nature is primitive and ancient, but Thales at any rate is said to have declared himself thus about... Anaximenes and Diogenes make air prior to water, and the most primary of the simple bodies ... Heraclitus of Ephesus says this of fire, and Empedocles says it of the four elements, for these, he says, always remain and do not come to be, except that they come to be more or fewer, being aggregated into one and segregated out of one... Anaxagoras of Clazomenae, who, though older than Empedocles, was later in his philosophical activity, says the principles are infinite in number; for he says almost all the things that are made of parts like themselves, in the manner of water or fire, are generated and destroyed in this way, only by aggregation and segregation, and are not in any other sense generated or destroyed, but remain eternally"*.

Aristotle saw completeness or perfection in finiteness, symmetry, and harmony. For example, infinite *Apeiron* was incomplete by its nature.

Aristotle concluded that a common factor in his predecessors' ideas was a first cause, material cause, for the existence of material; the material cause can be considered eternal. He commented on Leucippus's and Democritus's atomism by stating, that "... for them the material causes are "full" or "empty" calling the one "being" and the other "non-being ...". Democritus's elements and all observable are differentiated by shape, order and position. Aristotle adopted Empedocles's system of four elements and described each element using the complementary characters suggested by Anaximenes, Figure 1-8.

Aristotle states that the Pythagoreans were the first to include mathematics in natural philosophy by arguing that all natural laws are reflections of the laws of mathematics. It can be concluded from Aristotle's comments, that he saw Pythagoreans going too far with their explanations based on numbers. Aristotle discusses widely about

<sup>7</sup> Aristotle *Metaphysics*, Book I, Part 3, <http://classics.mit.edu/Aristotle/metaphysics.1.i.html>

<sup>8</sup> Aristotle, *Physics*, Translated by R.P Hardie and R.K Gaye, Book III, part 5.6, <http://classics.mit.edu/Aristotle/physics.html>

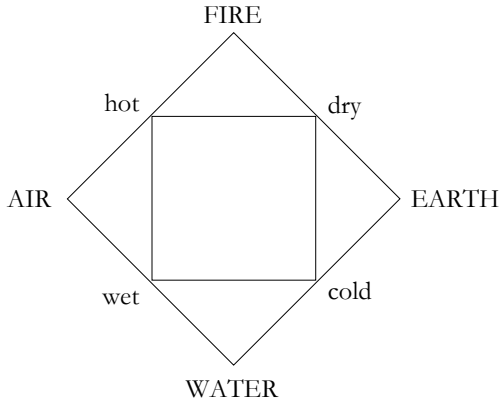

Figure 1-8. Elements and their properties in Aristotle's physics. The system is adopted from Empedocles who lived about one hundred years before Aristotle. The basis of the system originates from the time before Empedocles.

finitude and infinity. He linked infinity to continuity and indivisibly "... *the way Pythagoreans speak about infinity is absurd. With the same breath they treat the infinite as substance, and divide it into parts*"<sup>9</sup>. Aristotle saw matter as continuous but divisible. It looks, however, that Aristotle adopted the Pythagorean ideas of opposites and complementarity as primary principles in nature.

Aristotle found several inconsistencies in his predecessors' thoughts, but at the same time he admitted that they had much to give. He appreciated highly Plato's work; regarding Plato's tutor, Socrates, Aristotle states that he "... *was busying himself about ethical matters and neglecting the world of nature as a whole...*"<sup>10</sup>.

The antique inheritance of mechanics is included in Aristotle's teachings of motion, with its metaphysical basis in the idea of potentiality and the first movent as the initiator and the means maintaining the motion. Aristotle assumed that the velocity of an object is directly proportional to the force maintaining the motion and inversely proportional to the resistance of the medium. Aristotle's idea of free fall seems to apply to a situation, where the velocity of fall is restricted by the resistance of the air – he saw it as the *natural velocity* an object has on the way to its *natural location*.

Aristotle defined free fall as *natural motion*, motion toward the object's natural location; motion in the horizontal direction was *forced motion* activated and maintained by the movent. Aristotle's movent was external to the moving object. Accordingly, forced motion cannot occur in a vacuum. The motion of celestial bodies occurred in an *aether* without the need of a movent. In spite of the fact that Aristotle demanded understanding of first causes and a minimum number of postulates, his laws of terrestrial motion did not apply to celestial motion – neither did his system of terrestrial elements apply as building blocks of celestial bodies, space and heavens. In general, different materials and material objects were composed of four elements in different proportions, with four different properties, which should be understood in a symbolic way.

<sup>9</sup> Aristotle, *Physics*, Translated by R.P Hardie and R.K Gaye, Book III, part 5.6, <http://classics.mit.edu/Aristotle/physics.html>

<sup>10</sup> Aristotle *Metaphysics*, Book I, Part 6, <http://classics.mit.edu/Aristotle/metaphysics.1.i.html>

Aristotle introduces physics in his work *Physics*<sup>11</sup> written in eight books. The basic definitions can be summarized as follows:

*Terrestrial motion* may be directed up or down toward the natural location of the object. Horizontal motion is generated by collisions, sliding, and possible changes in the composition of the object.

*Natural motion* is motion up or down at constant velocity toward the natural location or state of the object. Natural motion does not need movent. Celestial objects do not need movent either. Celestial objects move at constant velocity in an aether.

*Velocity, weight and resistance:* The ideal velocity of an object is directly proportional to the weight of the object. The resisting medium limits the velocity in inverse proportion to the viscosity of the medium.

*A vacuum is not possible,* but, in principle, the velocity of an object in a vacuum would be infinite.

*Continuity:* Aristotle opposes Democritus's indivisible atoms.

*The Sun, the Moon, planets, and stars* are fixed to crystal wheels or spheres rotating at constant angular velocity. Because the celestial bodies do not fall down, they are not composed of terrestrial elements but of light eternal *aether*.

*Terrestrial elements* are described in terms of their properties, Figure 1-8. The properties of *water* are *wet* and *cold*, the properties of *air* are *hot* and *dry*, etc.

In spite of its apparent insufficiency and failures, Aristotle's doctrines of motion and matter maintained their position for almost two thousand years – until the development toward Newtonian mechanics was triggered in the 16<sup>th</sup> and 17<sup>th</sup> century AD.

In astronomy, Aristotle adopted Anaximander's model of celestial bodies. Anaximander's model was later replaced by the epicyclic model, which after several development steps obtained the form presented by Ptolemy in the 2<sup>nd</sup> century AD. Ptolemy's model and a vast collection of observations formed the main ancient inheritance in astronomy.

## Toward the modern era

After the antique golden centuries, the scientific activity in Europe had almost ceased until the dawn of the modern period in the 16<sup>th</sup> century. There is some documentation of activities outside Europe. The Indian astronomer Aryabhata (476–550 AD) presented a planetary model, in which the Earth rotates around its axis, and the orbital periods of the planets have been calculated in relation to the Sun. The use of the Sun as the reference for the periods indicates that Aryabhata has considered the possibility of a heliocentric model.

In Islamic physics and astronomy, the Andalusian polymath scientist Ibn Bajjah (1095–1138 AD) developed models for a heliocentric planetary system and laws of motion rejecting the Aristotelian movent. Obviously, Bajjah identified also the

<sup>11</sup> Aristotle, *Physics*, Translated by W. D. Ross, <http://classics.mit.edu/Aristotle/physics.html>

principle of forces of action and reaction, currently known as Newton's third law. Ibn Bajjah is also known by the name Avempace.

The first known philosopher criticizing Aristotle's laws of motion may have been the Alexandrian John Philoponus (490–570 AD). Philoponus explained Aristotle's movent in terms of *impetus*, a property obtained by the moving object from the source of the motion. Impetus presented the "*motive power*" (*incorporeal motive énergeia*) maintaining the motion, a kind of internal alternative to Aristotle's external movent.

The further development of impetus had to wait for almost one thousand years, until the French priest and philosopher Jean Buridan (about 1300–1360) saw impetus as being proportional to the velocity and the quantity of material in motion – which in fact defined impetus as momentum, the product of velocity and mass. He realized that the cause of motion, which in the case of free fall is gravitation, creates the impetus of the moving body – in the motion up against gravitation the impetus of the moving body is released back to gravitation. Accordingly, the concept of impetus applied equally to Aristotle's natural motion and forced motion. While impetus abolished the principles of Aristotelian doctrines of motion, it can be seen as a manifestation of Aristotle's causality of potentiality and actualization.

Buridan's impetus remained more or less a philosophical concept without direct impact on the further development of mechanics and the laws of motion.

## From Copernicus's solar system to Newton's mechanics

### *Copernicus*

Copernicus collected the basis of his heliocentric planetary system in a 40 page script called *Commentariolus*<sup>12</sup> completed in 1514. For getting their response, Copernicus gave copies of the script to his colleagues in Kraków in 1515–1530.

The postulates for the heliocentric system given in the introduction in *Commentariolus* were the following:

- 1) There is no single center of all the celestial circles or spheres.
- 2) The center of the Earth is not the center of the universe, but only of gravity and of the lunar sphere.
- 3) All the spheres revolve about the Sun as their mid-point, and therefore the sun is the center of the universe.
- 4) The ratio of the Earth's distance from the Sun to the height of the firmament is so much smaller than the ratio of the Earth's radius to its distance from the Sun that the distance from the Earth to the Sun is imperceptible in comparison with the height of the firmament.
- 5) Whatever motion appears in the firmament arises not from any motion of the firmament, but from the Earth's motion. The Earth together with its circumjacent elements performs a complete rotation on its fixed poles in a daily motion, while the firmament and the highest heaven abide unchanged.
- 6) What appears to us as motions of the Sun arise not from its motion but from the motion of the Earth and our sphere, with which we revolve about the Sun like any other planet. The Earth has, then, more than one motion.
- 7) The apparent retrograde and direct motion of the planets arise not from their motion but from the Earth's. The motion of the Earth alone, therefore, suffices to explain so many apparent inequalities in the heavens.

The Sun is surrounded by the sphere of fixed stars and the orbits of planets in the following order:

- 1) fixed stars
- 2) Saturn, period 30 years
- 3) Jupiter, period 12 years
- 4) Mars, period 2 years
- 5) Earth, period 1 year
- 6) Venus, period 9 months
- 7) Mercury, period 80 days

---

<sup>12</sup> Copernicus, *Commentariolus*, <http://dbanach.com/copernicus-commentariolous.htm>

Copernicus states that the Earth is subject to three motions:

- 1) The Earth revolves annually in a great circle about the Sun in the order of the signs, always describing equal arcs in equal times. The distance from the center of the circle to the center of the Sun is  $1/25$  of the radius of the circle (which was the way Copernicus describes the eccentricity of the orbit). The Moon revolves around the Earth.
- 2) The Earth rotates around its axis, from west to east, once a day. Waters and the atmosphere follow the rotation. On account of this rotation the entire universe appears to revolve with an enormous speed.
- 3) The third motion is the motion in declination. For the axis of the daily rotation is not parallel to the axis of the great circle, but is inclined to it at an angle that intercepts a portion of a circumference, in our time about  $23 \frac{1}{2}$  degrees. (Copernicus explains both the change in the declination angle and the seasonal variations due to the declination angle).

Copernicus states that, as generally assumed, the system is subject to many motions the laws of which are not known, "...but the motion of the Earth can explain all these changes in a less surprising way...". At the time of *Commentariolus*, Copernicus had already solved, using his heliocentric model, the apparent retrograde motion of the outer planets. In *Commentariolus*, he states: "However, I have thought it well, for the sake of brevity, to omit from this sketch mathematical demonstrations, reserving these for my larger work".

With his larger work, he means his main work, *De revolutionibus orbium coelestium* (*On the Revolutions of Celestial Orbits*<sup>13</sup>) completed in 1543.

The first Chapter of the *De Revolutionibus*, is titled *The Universe is Spherical*.

*"First of all, we must note that the universe is spherical. The reason is either that, of all forms, the sphere is the most perfect, needing no joint and being a complete whole, which can be neither increased nor diminished; or that it is the most capacious of figures, best suited to enclose and retain all things; or even that all the separate parts of the universe, I mean the sun, moon, planets and stars, are seen to be of this shape; or that wholes strive to be circumscribed by this boundary, as is apparent in drops of water and other fluid bodies when they seek to be self-contained. Hence no one will question the attribution of this form to the divine bodies."*

In the second chapter Copernicus argues the spherical shape of the Earth by comparing the night skies in the northern and the southern hemisphere. Also, he reminds of the fact that land which is not seen from a ship is visible from the top of its mast. Also, Copernicus makes a notation to Columbus's findings. He concluded that America is a continent or an island opposite to India on the globe.

There was no direct continuation of Copernicus's work after the publication of *De Revolutionibus*. Only the works of Kepler, Galilei and Newton, for more than one hundred years later showed the importance of Copernicus's work as the precursor of the scientific revolution. Copernicus's conclusions meant a revolution not only in astronomy but also invalidated the basis of Aristotelian physics in a wide sense.

<sup>13</sup> Copernicus, *De revolutionibus orbium coelestium*, <http://www.webexhibits.org/calendars/year-text-Copernicus.html> , <http://www.math.dartmouth.edu/~matc/Readers/renaissance.astro/1.1.Revol.html>



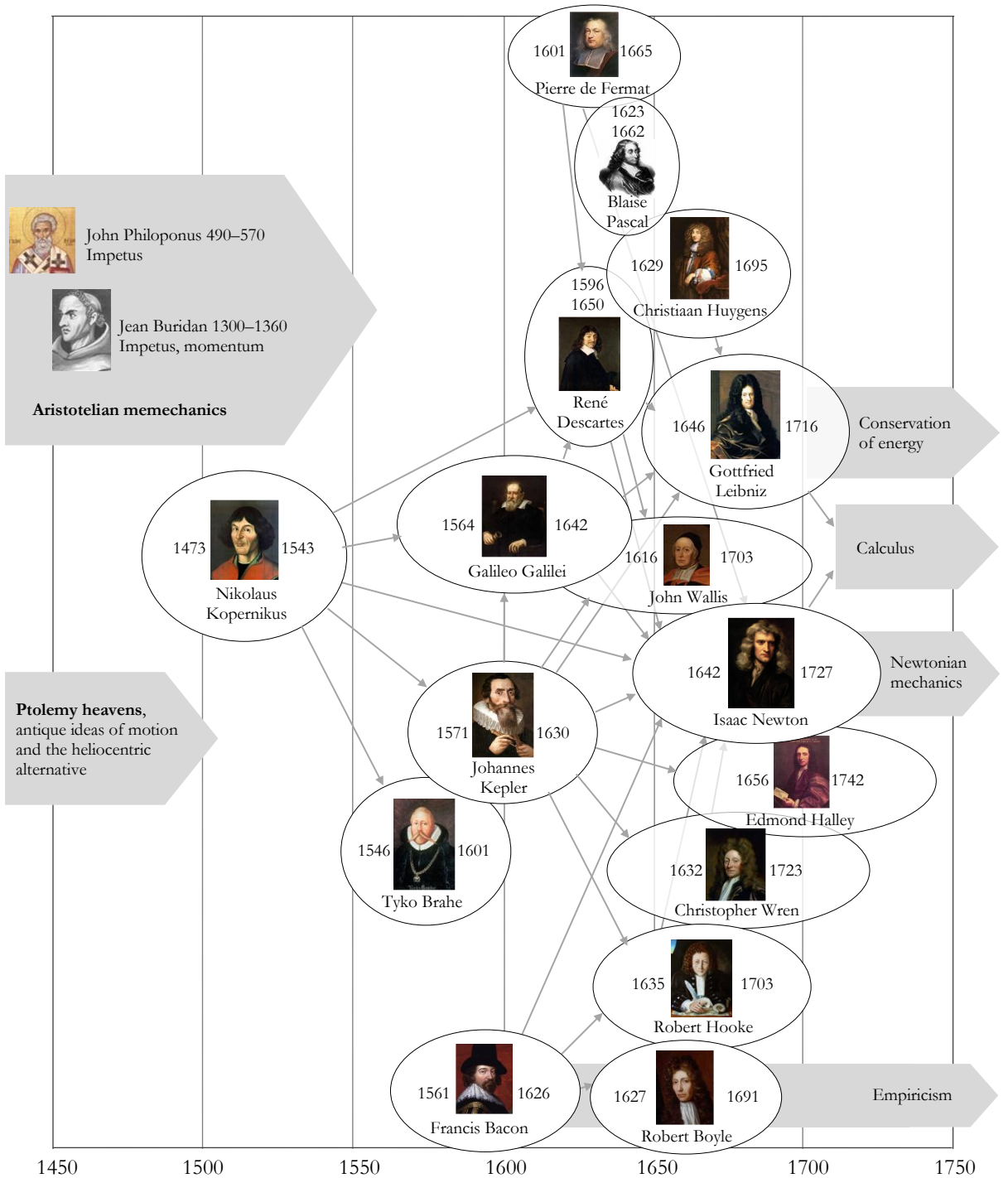

Figure 1-9. Development paths of mathematics, physics and astronomy in the beginning of the modern era. The conception of celestial mechanics, mass, momentum, force, and the laws of motion meant linkage of empirical research and mathematical description to a general view of physical reality.

Figure 1-9 gives a rough idea of the development paths toward the scientific revolution. Copernicus's ideas had to wait for more than one hundred years for scientific confirmation and general acceptance. The English mathematician and astronomer Sir Thomas Digges (1546-1594) translated the key Chapters in Copernicus's *De Revolutionibus* into English. As his own view he added that the fixed stars were distributed in infinite space behind Copernicus's sphere for the fixed stars. He was probably the first to realize the "dark sky paradox"<sup>14</sup> created by the huge number of stars.

Digges's contemporary, the Italian philosopher, mathematician and astronomer Giordano Bruno (1548-1600) went even further, stating that the Copernican solar system is just a minor group of stars among countless number of stars and star groups. Bruno's ideas were too radical in the 16<sup>th</sup> century. Gradually, in the 18<sup>th</sup> to 19<sup>th</sup> century, however, the position of the Sun as one of the stars was taken as an obvious fact. The position of the Milky Way as a galaxy among other galaxies, the diversity of galaxies as well as the huge cosmological distances opened up concretely first in the early 20<sup>th</sup> century – owing to the more efficient detection equipment.

### *Tycho Brahe*

As the first step toward the scientific development of the Copernican system, the Danish astronomer Tycho Brahe developed a heliocentric model in which the planets circulated around the Sun but the whole system of the Sun and planets was circulating around the static Earth, Figure 1-10. Tycho Brahe's model had a considerable resemblance to Heraclitus's model in the 4<sup>th</sup> century BC.

As a young astronomer Tycho Brahe was excited about the Copernican model. An apparent reason for the rejection of the Copernican system was the missing parallax, Figure 1-11(a). The parallax was too small to be detected with Brahe's instruments; it was detected first two hundred years later by Friedrich Bessel in 1838. The parallax measurement, however, did not become a practical method for the determination of distances until the 1980s, when the instruments, based on CCD (Charge Coupled Device) photodetectors, reached milli-arc-seconds accuracy in angle measurement.

The aberration of fixed stars due to the motion of the Earth was discovered by James Bradley in 1729. Because aberration is due to the motion of the observer it gave experimental support to the heliocentric Copernican system, Figure 1-11 (b).

Since ancient times, the fixed stars had been considered to be eternal and immutable. Tycho Brahe was the first to notice a change in fixed stars when he observed a supernova explosion in 1572. The lack of parallax indicated that the target was at the distance of fixed stars, which meant that the observation invalidated the old dictum of the immutability of the fixed stars.

There were several modifications of Tycho Brahe's model after his death. The most important one was probably Tycho Brahe's assistant's Logomontanus's model, in which he replaced Brahe's rotating celestial sphere with rotating Earth.

<sup>14</sup> Olbers' paradox, [http://en.wikipedia.org/wiki/Olbers%27\\_paradox](http://en.wikipedia.org/wiki/Olbers%27_paradox)

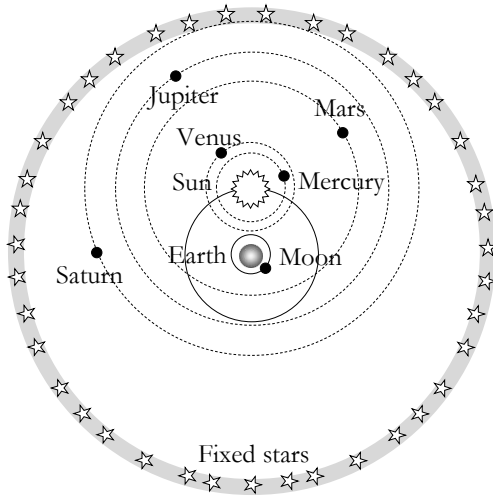

Figure 1-10. In Tycho Brahe's model the Earth is the fixed center. The Moon, the Sun, and the sphere of fixed stars rotate around the Earth and give the daily and the annual rhythm. Planets rotate around the Sun.

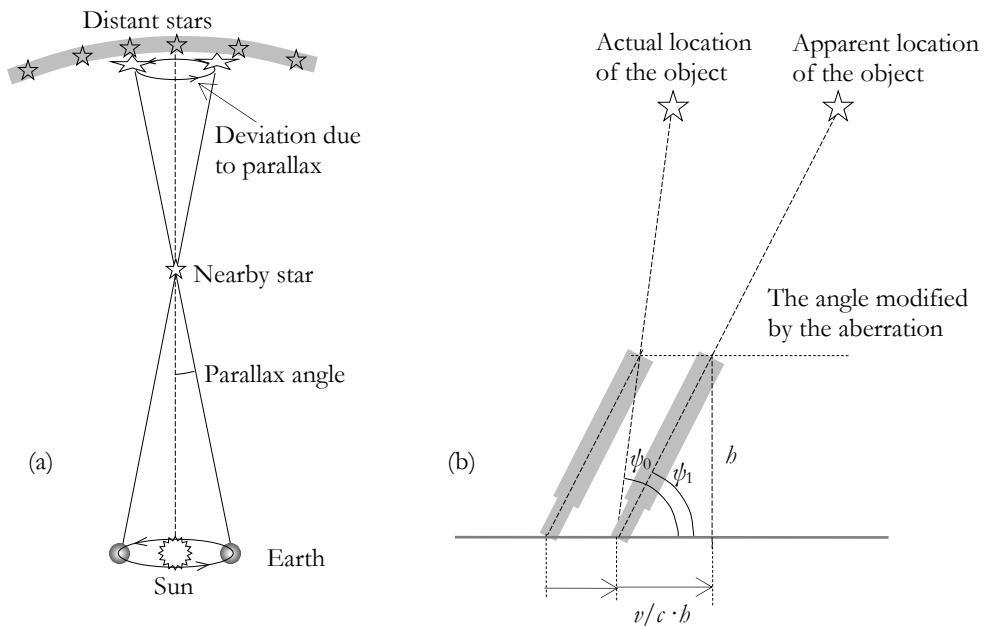

Figure 1-11. (a) If the Earth is assumed to revolve around the Sun, one should expect that the apparent position of nearby stars against distant stars should change during the year due to the parallax. The detection of the parallax was not possible with Tycho Brahe's instruments. (b) In the measurement of the angle of the object, due to aberration, the velocity of the observer gives rise to an apparent deviation from the actual observation angle. If the telescope used has the velocity  $v$  in the direction of the object at the observation plane, the telescope must be tilted to the angle  $\psi_1$ , in order to let the light entering to the top of the telescope reach the observer's eye at the lower end. The mechanism of aberration was first explained by the English astronomer James Bradley in the 18<sup>th</sup> century.

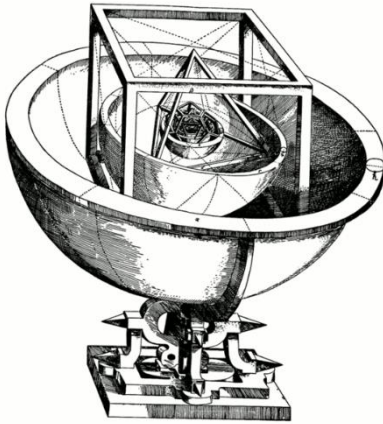

Figure 1-12. The planetary model based on the nested polyhedron in Kepler's *Mysterium Cosmographicum* was inspired by the heliocentric Copernican model. Figure, *Wikimedia Commons*.

Tycho Brahe's most important contribution to the development of astronomy was his precise observations, which made it possible for Johannes Kepler to conclude that the paths of planets around the Sun are ellipses. Tycho Brahe documented his observations in a list of stars *Astronomiae Instauratae Progymnasmata* completed by his successor Johannes Kepler after Tycho Brahe's death.

### *Johannes Kepler*

In 1596, Kepler published the book *Mysterium Cosmographicum* (*The Cosmographic Mystery*<sup>15</sup>), in which he probed the systematics of the planetary orbits with a model based on the nested polyhedron, Figure 1-12. Kepler wanted to show the justification of Copernicus's model with the inbuilt mathematical beauty. Tycho Brahe appreciated highly Kepler's *Mysterium Cosmographicum* and had noticed Kepler's mathematical abilities and approached Kepler to become his assistant in Prague in 1600. The start of the co-operation between Tycho Brahe and Johannes Kepler was troublesome. Tycho Brahe would rather have based the studies on his own hybrid model than on the Copernican model. The co-operation was cut when Tycho Brahe died suddenly in October 1601. After Tycho Brahe's death Kepler was appointed his successor as the Imperial Mathematician.

Kepler had not been able to match an eight arc-minute deviation in Tycho Brahe's observations in the Mars orbit to a circular model. After examining a large number of observational results on Mars, he finally realized that the orbit was an ellipse, so that the Sun is in one of the two focal points of the ellipse. He observed that the orbital velocity is at a maximum when the planet is close to the Sun and the smallest when it is furthest away from the Sun. A more detailed analysis showed that the orbital velocity varied in direct proportion to its distance from the Sun, which meant that areas of the orbital sectors swept by the planet in equal time intervals were equal.

<sup>15</sup> J. Kepler, *Mysterium Cosmographicum*, [http://en.wikipedia.org/wiki/Mysterium\\_Cosmographicum](http://en.wikipedia.org/wiki/Mysterium_Cosmographicum)

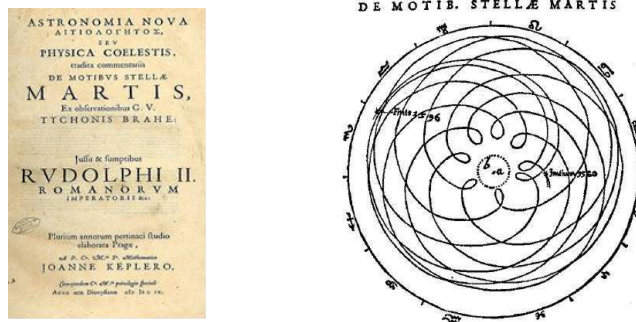

Figure 1-13. The cover page of Kepler's *Astronomia nova* (1609) and an illustration of the complex motions of the planet Mars in the Earth-centered coordinate system. Kepler was looking for mathematical beauty and accuracy, finally discovering, after many attempts, to the elliptic orbit with the Sun in one of the two focal points of the ellipse. The accurate observations of planet Mars by Tycho Brahe were the key for finding the elliptic orbit. Figure, *Wikimedia Commons*.

The same seemed to be true for other planets as well, which led to the formulation of Kepler's first and second laws:

- 1) The orbit of every planet is an ellipse with the Sun at one of the two focal points.
- 2) A line joining a planet and the Sun sweeps out equal areas during equal intervals of time.

The result was published in his *Astronomia Nova*<sup>16</sup> (*A New Astronomy*) in 1609, Figure 1-13.

Kepler had found the mathematical harmony of the planetary orbits. The harmony was completed by Kepler's third law, which he added in the last minute in his book *Harmonices mundi libri*<sup>17</sup> (*The Harmony of the World*) in 1619:

- 3) The square of the orbital period of a planet is directly proportional to the cube of the semi-major axis of its orbit.

Kepler was convinced that his findings confirmed the Pythagorean view that mathematics and harmonious relations are the key to the understanding of the visible world. In his book *Harmonices mundi libri* he followed the Pythagorean idea of the *symphony of the spheres* and outlined the connections between planetary orbits and musical intervals.

Kepler saw the sun as the source of light and assumed that the motion of the planets is powered by the Sun. He had also come to the conclusion that the Sun's light fades in inverse proportion to the square of the distance. Kepler did not recognize the essence of gravity, even though he thought that the tides are due to the Moon.

<sup>16</sup> *Astronomia Nova*, [http://en.wikipedia.org/wiki/Astronomia\\_nova](http://en.wikipedia.org/wiki/Astronomia_nova)

<sup>17</sup> *Harmonices Mundi*, [http://en.wikipedia.org/wiki/Harmonice\\_Mundi](http://en.wikipedia.org/wiki/Harmonice_Mundi), <https://archive.org/stream/ioanniskeplerih00kepl>

### Galileo Galilei

In 1604, Kepler had written the book *Astronomia pars Optica* (*The Optical Part of Astronomy*) related to optical phenomena in astronomy. In 1610, he heard about the telescope constructed by Galileo Galilei following the Dutch model as well as the observations Galilei had made of the moons of Jupiter. Kepler wrote immediately an enthusiastic letter to Galilei; a year later, after getting access to a telescope, he made observations on Jupiter's moons, and wrote the publication *Narration de Observatis Satellitibus Quatuor Jovis* (*Observations on Jupiter's Four Satellite*). The publication was of high value to Galilei, whose observations of Jupiter had been doubted. In 1611, Kepler wrote on the theory of the telescope; in his treatise *Dioptrice* he examined the combined effects of convex and concave lenses and the formation of a "false image" and a "true image".

Galilei's telescope observations on the changes in Venus's size indicated a change in distance. Observations supported Copernicus's model, in which Venus orbits the Sun, which results in a cyclic change in the distance to the Earth. In 1610's use of the telescope activated observations of the Sun, the Moon and the planets in several European observatories, which activated the discussion of the Copernican system. A result was that Galilei's previously favorable discussion with the representatives of the church began to turn into an attack against heresy.

Concerning the motion of the Earth the attack against Galilei was based on Psalms 93:1 and 96:10, "... *The Lord is clothed with strength, wherewith he hath girded himself; the world also is established, that cannot be moved*" and "*Say among the heathen that The Lord is reigneth: the world also shall be established that it shall not be moved...*", and, further, on chapter 16:30 in the first book of the Chronicles, "*Fear before him, all the earth: the world also shall be stable, that it be not moved*", and the words "*Who laid the foundations of the Earth, that it should not be removed for ever*" in Psalm 104:5. The Old Testament Ecclesiastes 1:5 states the motion of the Sun: "*The Sun also ariseth, and the Sun geth down, and hasteth to his place where he arose*".

In 1632, the controversy culminated in Galilei's literal response to the accusation for heresy. His response *Dialogo sopra i due massimi sistemi del mondo* (*Dialogue Concerning the Two Chief World Systems*<sup>18</sup>) was a satire formatted dialogue, in which the philosopher *Salviati* defends the Copernican system against the Ptolemaic planetary system and the Aristotelian physics supported by apparently simple *Simplikos*. A layman and a representative of common sense, *Sagredo*, who initially was neutral, adopted the Copernican system during the debate. Next year, the book was dealt with by the inquisition. The book was banned, and Galilei was sentenced "on suspicion of heresy". Galilei had to

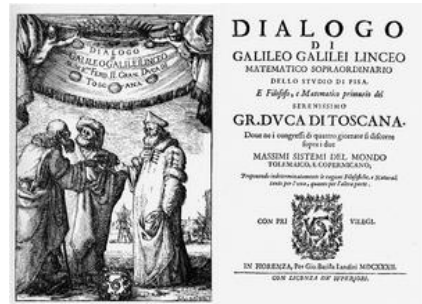

Coverpage of Galilei's *Dialogo*. Picture, *Wikimedia Commons*.

<sup>18</sup> *Dialogo*, English translation, <http://law2.umkc.edu/faculty/projects/frtrial/galileo/dialogue.html>

spend the rest of his life closed in his home – *Diálogo* was released from ban only in 1822.

Galilei's trial had a major impact on the separation of science from religion. More than the defense of Copernicus's model, Galilei's immediate impact on the development of science may, however, come from his empirical approach, which led to the replacement of Aristotle's natural and forced motion with mathematically described motion and its interaction with gravitation. Galilei's conclusions were based on the experiments with pendulums and free fall in the early 17<sup>th</sup> century. In 1607, Galilei showed that the ballistic curve is a parabola.

Galilei concluded that uniform motion is equivalent to the state of rest. Experiments made in a moving ship behaved in exactly the same way as in a ship moored in harbor – on board of a ship a ball thrown upwards comes straight down regardless of the ship's motion. This finding was important also for the Copernican system, because it justified the omission of the effects of the rotation and orbital velocity of the Earth in local terrestrial experiments.

Galilei defined the principle of relativity, which was later inherited in both Newton's mechanics and Einstein's special relativity: "*The laws of nature are the same in all systems in rectilinear motion*".

Galileo Galilei's work combined empirical research and mathematical description. Contrary to Aristotle's teachings, but following the ideas of John Philoponus and Jean Buridan, Galilei concluded that maintaining of a state of motion does not need an external movent – external force is needed only for changing the state of motion.

Galilei's experimental research was primarily on accelerating motion. He made precise observations and developed mathematical descriptions for the phenomena, which also meant an early outlining of the modern concept of force.

Galilei adopted the atomic doctrines of Democritus and Epicurus. He assumed that all physical objects are composed of atoms, and that all phenomena follow mathematically expressed laws describing atoms and their motions.

In addition to his scientific work, Galilei made numerous practical inventions from pumps to a geometric compass and improvements into the telescope. Even on his deathbed, he came up with the idea of a pendulum clock.

### *The dawn of empiricism, Francis Bacon*

In parallel to the empirical approach of Kepler and Galilei, the English philosopher and scientist, Francis Bacon awoke to declare the importance of empiricism as a scientific method. In his book, *Novum Organum Scientiarum (A new scientific method) – True directions Concerning the Interpretation of Nature*<sup>19</sup> published in 1620, he explained that science was directed by Aristotelian deductive reasoning derived from assumptions, instead of inductive reasoning based on observed facts.

The preface of the book begins with the statement: "*Those who have taken it on themselves to lay down the law of nature as something that has already been discovered and understood, whether*

<sup>19</sup> Bacon, *The New Organon*, <http://www.earlymoderntexts.com/authors/bacon>

*they have spoken in simple confidence or in a spirit of professional posturing, have done great harm to philosophy and the sciences”.*

With reference to science based on idea-driven hypotheses, he points out that some people have chosen the opposite path by realizing that once and for all, nothing can be *known*. Bacon sums up his thoughts in two parts with a total of 180 aphorisms in *Novum Organum*.

### René Descartes

In the 17<sup>th</sup> century, the development towards mathematical physics arose also in France. Although René Descartes searched for the causes and the laws of nature, he tried to bring his reasoning to an empirical level. Descartes argued that if a demonstrable causal reason can be shown for phenomena, it is impossible to enter into false conclusions. He compared science to a tree, whose roots are in metaphysics, trunk in physics, and the branches in various fields of science.

Descartes summed up his view of metaphysics and physics in his book *Principia Philosophiae*<sup>20</sup> (*Principles of Philosophy*) published in 1644. The book has four parts, Part 1: The principles of human knowledge, Part 2: The principles of material things, Part 3: The visible universe, and Part 4: The Earth.

Descartes began Chapter 2 of Principles of Philosophy by considering the bases that lead to knowledge or understanding of material existence. His conclusion was that in three dimensions there was something that had physical dimensions and characteristic properties. *“So, we are forced to the conclusion that there exists something extended in three dimensions and possessing all the properties that we clearly perceive to belong to an extended thing. And it is this extended thing that we call ‘body’ or ‘matter’ ”.*

Descartes identified a *body* primarily with its dimensions, length, width, and height. He considered that atoms with finite size were impossible; *“... in our thoughts we can always divide them into smaller and smaller parts”.* He came to the conclusion that the Earth and the heavens are made of a single kind of matter. Also, he concluded that the expanse of the universe is indefinite, and that there cannot be a plurality of universes.

Next, in Part 2, Descartes deals with motion. Descartes taught that any variety in matter and all the different forms it takes depend on motion. *“Motion, in the ordinary sense of that word, is simply the action by which a body travels from one place to another...”.* *“A piece of matter or body moves if it goes – from being in immediate contact with some bodies that are regarded as being at rest to being in immediate contact with – other bodies”.*

In paragraphs 2/26 and 2/27 Descartes states that *“Motion doesn’t require any more action than rest does”.* *“Motion and rest are merely various modes of a body in motion.”*

In paragraph 2/30 Descartes ponders relative motion: *“When two bodies in contact with one another are separated, and one but not the other is said to move, why is this?”* *“... The principal reason for this is that our thought of something, as moving is the thought of its all moving; and it’s impossible that when I walk the whole earth is moving.... If my walking eastward is said to involve*

<sup>20</sup> Descartes, *Principles of Philosophy*, <http://www.earlymoderntexts.com/authors/descartes>



*the whole earth's moving westward, then what can we make of the fact that while I walk eastward you walk westward?"* From this, Descartes continued on to describe the internal motion of matter in a flowing liquid.

Descartes stated that God is the primary cause of motion; *"and he always preserves the same quantity of motion in the universe"*.

Finally, Descartes formulated his ideas in the form of laws of motion:

- 1) Each thing when left to itself continues in the same state; so any moving body goes on moving until something stops it.
- 2) Each moving thing, if left to itself, moves in a straight line; so any body moving in a circle always tends to move away from the center of the circle.
- 3) (a) If one body collides with another that is stronger than itself, it loses none of its motion; (b) If it collides with a weaker body, it loses the same amount of motion that it gives to the other body.

Descartes explained law 3 (a) by stating that the change in the direction in a collision does not change the quantity of motion. In law 3 (b), he saw God's way of operating so that the total quantity of motion is conserved.

For Descartes the quantity of motion meant the product of the size and the velocity of a body. He gave several examples of how to apply the laws of motion and discussed the properties of various types of matter and bodies. The Dutch scientist, Christiaan Huygens (1629–1695) refined Descartes's concept of the quantity of motion and introduced the mathematical expression for central acceleration in 1659.

Descartes starts Part 3 *The visible Universe* in *Principles of Philosophy* with a statement of the vastness of the works of God, and the limits of our possibilities to understand it; *"it is enough that we understand that God made everything for our benefit... however, we must understand that there are many things in the world that have never been seen or thought of by any man, and have never been of any use to anyone"*.

Further, Descartes noted that the Sun can be considered as one of the fixed stars, and the Earth as one of the planets. He noted that the movements of planets can be explained by different hypotheses; Ptolemy's hypothesis does not correspond to observations, and that Tycho Brahe's hypothesis is more complex than the hypothesis of Copernicus. With reference to his definitions of motion and the state of rest, Descartes conserved the local state of rest on the Earth and on planets by thinking that each one is at rest in the "local heaven" following the orbiting system of Copernicus.

Part 3 of the *Principles of Philosophy* consists of 157 numbered statements. Although Descartes emphasized the importance of the knowledge of the causal causes, his conclusions on the structures of the universe were somewhat indefinite – many of them were more questions than answers.

Part 4 of the *Principles of Philosophy* is called *The Earth*. It deals with terrestrial observations. The discussion is more like listing the questions of importance. The general spirit of Descartes's time is reflected in the final statement in Section 4, in which Descartes submits all his views to the authority of the Catholic Church *"...and I*

wouldn't want you to believe anything I have written unless you are convinced of it by evident and irrefutable reasoning".

### Robert Boyle

Following the strengthening spirit of empiricism and Francis Bacon's ideas, the English polymath scientist Robert Boyle (1627-1691) defined the scope of physics as the science of *matter* and *motion*.

In the Introduction of his book, *The Grounds for and Excellence of the Corpuscular or Mechanical Philosophy*<sup>21</sup> he stated that his mechanical philosophy deals only with purely corporeal things and the rules of motion as well as the order amongst bodies that are ordinarily called '*the laws of nature*'. He summarized the bases of his mechanical philosophy as follows:

- 1) Firstly, there is the fact that mechanical principles and explanations are intelligible, *clear*.
- 2) There can't be fewer principles than the two grand ones of mechanical philosophy, matter and motion.
- 3) We can't conceive any principles more basic than matter and motion. Either both of them were immediately created by God – or, if matter is eternal and thus was never created – it must be the case that motion is something that the moving matter just naturally produces itself.
- 4) There can't be any physical principles that are simpler than matter and motion, because there's no truthful or even reasonably plausible way of representing either of them as compounded out of two or more simpler items.
- 5) Corpuscular principles are enormously comprehensive. If one part of matter  $x$  collides strongly enough with another  $y$ , the necessary effect of this is either to break or divide  $y$  up into particles that have determinate motions, shapes, sizes, postures, orders and textures.

Boyle's emphasis on matter and motion was related to his conviction of atomism. He assumed that material is built up of atoms and groups of atoms, and chemical reactions are consequences of collisions between atoms. Boyle's heritage had a major impact among chemists; the atomic structure of material has been obvious to chemists through history after Boyle – among physicists, atomic theory was established first at the end of the 19<sup>th</sup> century.

### Gottfried Leibniz

Leibniz's extensive scientific work combines a deep metaphysical basis and mathematical thinking to a holistic view of physical phenomena. Leibniz identified the "*natural inertia*" of material bodies. Leibniz's natural inertia was directly proportional to the weight of the body, which made it resist changes in motion, essentially in the same way as Kepler's natural inertia. Leibniz characterized the properties of material bodies in terms of their solidness and firmness; solidness resisted elasticity and

<sup>21</sup> Boyle, *The Grounds for and Excellence of the Corpuscular or Mechanical Philosophy*, <http://www.earlymoderntexts.com/assets/pdfs/boyle1674a.pdf>

firmness kept the body solid. The concept of elasticity was essential for describing continuity and the conservation of *vis viva*, the living force, in elastic collisions.

In his script criticizing Descartes's laws of motion *A Brief Demonstration of a Notable Error of Descartes and Others Concerning a Natural Law, According to which God is Said Always to Conserve the Same Quantity of Motion; a Law which They also Misuse in Mechanics*<sup>22</sup>. Leibniz expressed his own view of the laws of motion as follows:

The force (*vis viva*, *kinetic energy in modern definitions*) which an object acquires when falling from a certain altitude is equal to the force that would be required to raise it back to the same altitude.

- 1) The force a one pound body acquires by falling from a height of four meters is equal to the force a four pound body acquires by falling from a height of one meter.
- 2) Galilei's Law: the distance traveled by a falling body is directly proportional to the square of the time it falls ( $d = at^2$  where  $a$  is a constant); a falling body traveling a distance of one meter in one second will travel four meters in two seconds, nine meters in three seconds, and sixteen meters in four seconds, etc.
- 3) The total amount of force in the world is conserved both locally and globally with the result that there is always as much force in a cause as in its effect.

In modern terms Leibniz's "force" means energy, which was first identified as the integrated force in the 19<sup>th</sup> century. In modern terms the definition in point 3) means global balance between released gravitational energy and the kinetic energy acquired. In his script *Essays in Dynamics, Part 2/20: The laws of Nature*<sup>23</sup>. Leibniz summarized the laws of motion as follows

- All changes are gradual
- Every action also has a reaction
- No new force is produced without reducing an earlier one, so that a body that pushes away another body will be slowed down by it
- There is neither more nor less power in an effect than in its cause

In Leibniz's conception, cause can be identified as potential energy, which is also called *vis mortua* (*dead force*), and effect as kinetic energy or the energy of motion, which he called *vis viva* (*living force*),  $mv^2$ . In elastic collisions the living force is conserved; Leibniz realized that continuity presupposes elasticity – in an elastic collision the living force is first stored as stress, *vis mortua*, in the elastic material, and then released back to living force in the post-collision motion. In the case of non-elastic collisions, Leibniz explained, part of the living force is divided into many parts resulting in a change in the shape of the bodies thus eliminating part of the net motion.

Leibniz justified his claims 1) and 2) with simple experiments and the properties of a pendulum. A pendulum shows that the living force acquired in fall is able to take the oscillating body back to the same altitude from which the motion was started. He stated that Descartes's quantity of motion (momentum) does not fulfill this

<sup>22</sup> [Stanford Encyclopedia of Philosophy, Leibniz's Philosophy of Physics](#)

<sup>23</sup> Leibniz, Essay in Dynamics, Part 2, The Laws of Nature, <http://www.earlymoderntexts.com/assets/pdfs/leibniz1695b.pdf>

requirement, a fact that can be proven with a simple experiment: The force needed to raise a body A, which is one pound in weight, up to the altitude of four feet, is equal to the force needed to raise a body B, which is four pounds in weight, up to the altitude of one foot, Figure 1-14. We may assume that the living force acquired by body A when falling down from the altitude of four feet is equal to the living force acquired by body B when falling down from the altitude of one foot.

Galileo Galilei has shown that independent of the weight of the falling body, the velocity acquired in a fall from an altitude of 4 feet is double the velocity acquired in a fall from an altitude of 1 foot. According to Descartes, the quantity of motion is the product of the size and the velocity of a body. Accordingly,  $2 \times A$  for body A and  $1 \times B = 4 \times A$  for body B in the experiment described, which meant that the quantity of motion acquired by body A would be only half of the quantity of the motion acquired by body B, although we just concluded that the “force of motion” acquired in the two cases should be equal. The living force  $mv^2$  ( $4 \times A$ ), however, is equal in both cases.

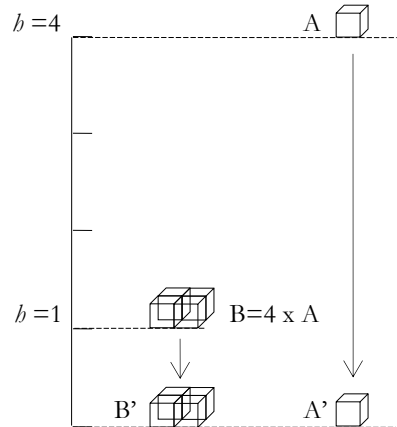

Figure 1-14. Leibniz's experiment for the determination of *vis viva*.

Leibniz concluded that the “force of motion” shall be estimated from the effect it produces; the effect can be measured as the height the body is lifted by the force. Leibniz concluded that the criticism against Huygens's theory of a pendulum was due to the confusion regarding the concept of the quantity of motion. In his *Discourse on Metaphysics*<sup>24</sup> (1686) Leibniz states that against the teachings of Descartes and many other competent mathematicians, the quantity conserved is not Descartes's quantity of motion ( $m$ ) but the living force, *vis viva* ( $mv^2$ ).

As is obvious from the description of the experiment with falling bodies, Leibniz's living force means the energy gained in obtaining the motion, which, in the case of free fall is equal to the gravitational energy released. In the case of free fall and the pendulum, it is question of the conversion of potential energy to the energy of motion and vice versa – which cannot be directly concluded from the momentum or the “quantity of motion”. As understood later, in collisions both the conservation of kinetic energy and conservation of momentum apply. The apparent contradiction is due to the fact that energy is treated as a scalar quantity and momentum as a vector quantity.

As expressed in his third letter to Samuel Clarke, Leibniz considered Newton's law of gravitation as being absurd, because it meant action at distance between atoms separated by empty space. Instead of separate atoms Leibniz considered that there is nothing separate in the universe. In his concept of monads, he described the

<sup>24</sup> Leibniz, *Discourse on Metaphysics*, <http://www.earlymoderntexts.com/assets/pdfs/leibniz1686d.pdf>

elementary parts (monads) as “perpetual living mirrors of the universe”. Leibniz’s negative reaction to Newton’s law of gravity may be partly related to the controversy that had been triggered by Newton’s colleagues accusing Leibniz of plagiarizing Newton’s calculus.

*Vis viva, vis mortua – impetus, conatus*

Obviously, Leibniz was searching for a physical expression for Aristotle’s *entelecheia*, the actualization of potentiality. Leibniz had recognized gravity, the mechanical tension in a spring, as well as elastic compression as *vis mortua* (*dead force*) or potential energy, which may be converted into *vis viva* (*living force*) or kinetic energy. Similarly, the living force could be converted back to dead force as in an elastic collision, a pendulum or an oscillating spring.

Leibniz’s living force (*vis viva*) was identified with the concept of kinetic energy first more than a century later. When developing the principles of integral calculus, Leibniz related the “elementary precursor of motion” to the concept *conatus* corresponding to “force” in Newton’s equation of motion. The motive power *impetus* was obtained by integrating the available *conatus*.

Newton defined and used the concept of force both in the equation of motion (the second law) and the law of gravitation. The concept of energy as integrated force was understood more than a century later. The principle of the conservation of energy was identified in the development of analytical mechanics and thermodynamics. The role of the conservation of energy as a fundamental law of nature was finally formulated by Hermann Ludwig von Helmholtz in the middle of the 19<sup>th</sup> century.

## Newton and Principia

Newton’s gigantic achievement was the compatible formulation of the laws of motion and gravitation based on clear postulates and straightforward mathematics. Newton was able to show the physical basis of the heuristic, elliptical planetary orbits identified by Kepler in his careful study of Tycho Brahe’s observations. Newton collected his theory and calculations into his historical work *Philosophiae Naturalis Principia Mathematica* (*Mathematical Principles of Natural Philosophy*), first published in 1687.

The origin of Principia can be traced back to the scientific activity in the Royal Society established in 1660 in England. In 1666, one of the founders of the Society, the English natural philosopher and polymath Robert Hooke, had given a talk on *The System of the World*. In his talk he had stated, for example, the following proposition as laws of nature<sup>25</sup>:

- 1) *All the heavenly bodies have not only a gravitation of their parts to their own proper center, but that they also mutually attract each other within their spheres of action.*

<sup>25</sup> Citation of Hooke’s 1666 Royal society lecture “On gravity”, [http://en.wikipedia.org/wiki/Robert\\_Hooke](http://en.wikipedia.org/wiki/Robert_Hooke)

- 2) *All bodies having a simple motion, will continue to move in a straight line, unless continually deflected from it by some extraneous force, causing them to describe a circle, an ellipse, or some other curve.*
- 3) *That this attraction is so much the greater as the bodies are nearer. As to the proportion in which those forces diminish by an increase of distance, I own I have not discovered it...*

In 1679, Hooke wrote to Newton in order to ask Newton's opinion on the idea of dividing the planetary motion into tangential and radial (centripetal) components for studying his view that "... the centripetal component is inversely proportional to the second power of the distance from the center". Hooke was not able to prove his view mathematically, and the idea was left maturing for a while.

In 1684, inspired by Hooke's ideas, the highly appreciated architect and mathematician, Christopher Wren challenged Robert Hooke and the astronomer, mathematician Edmond Halley to derive a mathematical theory that would link Kepler's laws to a specific law of force. Halley delegated the task to Newton. Newton responded to Halley with a nine-page paper *De motu corporum in gyrum*<sup>26</sup> (*The Motu, On the motion of bodies in an orbit*). Inspired and sponsored by Halley, Newton expanded *The Motu* into *Principia* in 1687.

The following comments and citations refer to the English translation<sup>27</sup> of the third edition of *Principia*, first published in 1725.

The *Principia* begins with the definitions required by the laws of motion:

- 1) *The quantity of matter is a measure of matter that arises from its density and volume jointly.*
- 2) *Quantity of motion is a measure of motion that arises from the velocity and the quantity jointly.*
- 3) *Inherent force of matter is the power of resisting by which every body, "so far as it is able", preserves in its state either of resting or of moving uniformly straight forward.*
- 4) *Impressed force is the action exerted on a body to change its state either of resting or of moving uniformly forward.*
- 5) *Centripetal force is the force by which bodies are drawn from all sides, are impelled, or in any way tend, toward some point as the center.*

In points 6–8 Newton makes some further statements concerning centripetal force.

Newton expresses the laws of motion as axioms:

- 1) *Every body perseveres in its state of being at rest or of moving uniformly straight forward, except insofar it is compelled to change its state by forces impressed.*
- 2) *A change in motion is proportional to the motive force impressed and takes place along the straight line in which that force is impressed.*
- 3) *To any action there is always an opposite and equal reaction; in other words, the action of two bodies upon each other are always equal always opposite in direction.*

Based on law 3) Newton infers the conservation of the quantity of motion in collisions, and the conservation of the center of mass of a body in uniform motion.

<sup>26</sup> Introduction of *DeMotu* [http://en.wikipedia.org/wiki/De\\_motu\\_corporum\\_in\\_gyrum](http://en.wikipedia.org/wiki/De_motu_corporum_in_gyrum)

<sup>27</sup> *Principia*, A New Translation by I. Bernard Cohen and Anne Whitman, University of California Press, London/Los Angeles (1999)

Books 1 and 2, titled *The Motion of Bodies*, introduce applications of the laws of motion in many different situations. Newton studied extensively the properties of central motion and orbits before defining gravitation – in fact, Newton tried to avoid the postulation of gravitational force by looking for a centripetal force that would explain the Keplerian elliptic orbits. By comparing the orbital velocity, the radius and the period in circular orbits he concluded that a centripetal force that is inversely proportional to the square of the radius leads to orbits fulfilling Kepler's third law regarding the ratio of the radius and the period. He then generalized the result by replacing the radius of circular orbits with the semimajor axis of elliptic orbits thus meeting the goal of showing the mathematical basis of Keplerian orbits and basis for the definition of the gravitational force with the quadratic dependence of the inverse distance.

A gravitational force inversely proportional to the square of distance had been proposed by several astronomers before Newton. One of them was the French amateur astronomer Ismael Bulliau (1605–1694), who in his book *Astronomica Philolaica* in 1645 supported Kepler's elliptic orbits but criticized Kepler's conception of gravitational force that was inversely proportional to the distance from the Sun. Bulliau concluded that like the intensity of light from the Sun decreases in inverse proportion to the square of the distance, the gravitational force should, if such a force existed, also decrease in inverse proportion to the square of the distance between the Sun and the orbiting planet. Newton made a reference to Bulliau's measurements but not to his conclusion on the gravitational force.

Newton added the discussion of the gravitational force to the *General Scholium* in Book 3, *The System of the World*, in *Principia*, after getting strong support from Edmond Halley.

The concept of gravitational force linked the centripetal force, inversely proportional to the orbital radius, to the masses of the central body and the orbiting body, which gave the ontological basis to the force behind planetary orbits. In book 3 Newton states that the force that he used to call the centripetal force, will be in the future called the gravitational force which is related to the masses of the bodies. Newton begins the Book 3 with *Rules for the study of natural philosophy*:

- 1) *No more causes of natural things should be admitted than are both true and sufficient to explain their phenomena.*
- 2) *Therefore, the causes assigned to natural effects must be, so far as possible, the same.*
- 3) *Those qualities of bodies that cannot be intended and remitted [i.e., qualities that cannot be increased and diminished] and that belong to all bodies on which experiments can be made should be taken as qualities of all bodies universally.*
- 4) *In experimental philosophy, propositions gathered from phenomena by induction should be considered either exactly or very nearly true notwithstanding any contrary hypotheses, until yet other phenomena make such propositions either more exact or liable to exceptions.*

Rule 4 should be followed so that arguments based on induction may not be nullified by hypotheses.

Newton continues Book 3 with Chapter *Phenomena*, showing that observational results of planetary motions correspond to Kepler's laws.

In Chapter “*Propositions*”, with reference to observations, he starts with the moons of Jupiter stating that the forces that draw the moons from rectilinear motion are directed towards the center of Jupiter and they are inversely proportional to the orbital radius. The same is true for Saturn’s companions.

Newton states that the validity of the Keplerian orbits and the force which is inversely proportional to the square of the distance from the orbiting object to the center of the orbit is confirmed by observations for all planets as well as the Moon and the satellites of Jupiter and Saturn. As a summary, Newton states that the gravitational effect between orbiting masses and the corresponding central masses is a universal effect. Also, gravitation occurs between planets. Therefore, the gravitation between Jupiter and Saturn, when the two planets are closest to each other, results in disturbances to their orbits around the Sun. Each celestial body gravitates each planet with a force that is proportional to the mass of the celestial body in question.

Newton concludes that the weight of a body does not depend on the shape or structure of the body. Bodies close to the Earth are observed as being heavy. The weight of bodies at equal distances from the Earth describes the quantity of matter in the bodies. Gravitation is a property of all material bodies and it is proportional to the quantity of matter in the bodies. Newton links gravity to the concept of the quantity of matter and the concept of mass to the concept of inertial property – *the density of bodies with equal size is equal, if their inertial force (mass) is equal*. Accordingly, Newton links the quantity of material to gravitational mass and the inertial force to the mass resisting the change of motion. Newtonian celestial mechanics assumes the equivalence principle which means the equivalence of the gravitational mass and the inertial mass.

Newton states that in going inward from the surfaces of planets, gravity decreases very nearly in the ratio of the distances from the center. In proposition 10 he states that motions of the planets can continue in the heavens for a very long time.

In Hypothesis 1, Newton states that the center of the system of the world is at rest, which means that the common center of gravity of the Earth, the Sun, and all the planets is at rest. If this center, however, moves uniformly straight forward, the center of the universe will also move, contrary to the hypothesis. The Sun is in a continuous motion, but it never recedes far from the common center of gravity of all the planets. *“The planets move in ellipses that have a focus in the center of the Sun, and by radii drawn to that center they describe areas proportional to the times”*.

In total, there are 98 propositions in Book 3. Newton goes carefully through a great number of known observations and conclusions drawn from the theory presented. He concludes that rotating celestial objects are flattened at their poles. He estimates that in the case of the Earth, the equatorial radius is more than 17 miles longer than the polar radius. Further, he estimates the effects of the Moon and the Sun on the seas and the tides and analyses the orbits of comets.

In the *General Scholium* of *Principia*<sup>28</sup> Newton concludes that the most elegant system of the Sun, planets, and comets could not have arisen without the design and

---

<sup>28</sup> *Principia*, A New Translation by I. Bernard Cohen and Anne Whitman, University of California Press, London/Los Angeles (1999)



dominion of an intelligent and powerful being. *”And if the fixed stars are similar systems, they will all be constructed according to a similar design and subject to dominion of One, especially since the light from the fixed stars is of the same nature as the light from the Sun, and all the systems send light to all others. And so that the system of the fixed stars will not fall upon one another as a result of their gravity, he has placed them at immense distances from one another”.*

In *General Scholium* Newton continues: *”Thus far I have explained the phenomena of the heavens and of our sea by the force of gravity, but I have not yet assigned a cause to gravity. Indeed, this force arises from some cause that penetrates as far as the centers of the Sun and the planets without any diminution of its power to act, and that acts not in proportion to the quantity of the surfaces of the particles on which it acts but in proportion to the quantity of solid matter, and whose action is extended everywhere to immense distances, always decreasing as the squares of the distances”.*

Newton himself was not happy with the action at distance he had to assume. In the *General Scholium* of the previous edition (second) of *Principia* he had argued his law of gravity as follows:

*“... But hitherto I have not been able to discover the cause of those properties of gravity from phenomena, and I frame no hypotheses. For whatever is not deduced from the phenomena, is to be called an hypothesis; and hypotheses, whether metaphysical or physical, whether of occult qualities or mechanical, have no place in experimental philosophy. In this philosophy particular propositions are inferred from the phenomena, and afterwards rendered general by induction. Thus it was that the impenetrability, the mobility, and the impulsive force of bodies, and the laws of motion and of gravitation, were discovered. And to us it is enough, that gravity does really exist, and act according to the laws which we have explained, and abundantly serves to account for all the motions of the celestial bodies, and of our sea”.*

Newton’s *Principia* raised the natural sciences immediately to a new level. *Principia* fulfilled the central principles of scientific work, like systematic progress from clear definitions and postulates to conclusions by careful analysis of observations. The *Principia* illustrates Newton’s deep metaphysical view and his sincere efforts to identify the basic laws of nature. At the same time *Principia* showed the power of mathematics in the description of natural phenomena. The laws of motion and gravitation made it possible to analyze observations at a level, which was far from anything before.

Newton’s work would not have been possible without the prior work of his predecessors on the laws of nature, definitions and concepts, experiments and systematic observations before him. Newton’s work meant a breakthrough of mathematical physics and empirical research by showing the power of precise mathematical analyses in the test of hypotheses.

Newton’s laws of motion and gravitation made *force* a central quantity in physics and the principle of equivalence a basic law of nature. Implicitly, the “force-based” laws of motion assumed a local state of rest in endless space where the velocity increases linearly without limits as long as constant force is applied on the object accelerated. The concept of energy as the primary conservable in closed systems was identified almost two hundred years later. In classical mechanics, the kinetic energy was derived by integration from Newton’s second law.

The coordinate system behind Newtonian mechanics is generally referred to as an inertial frame of reference. Two inertial frames of reference moving relative to each other at constant velocity are considered equal, either one of the frames can be considered as the being at rest. Regarding the laws of motion, the Newtonian world does not have a universal state of rest – although Newton assumed that the Sun, or the barycenter of the solar system, is the center of space at rest. Transformation between Newtonian inertial frames is performed using Galilei's transformation that adds the relative velocity of the frames in frame to frame observations.

Implicitly, the concept of inertial frames includes the hypothesis of the principle of relativity, which states that the laws of motion as well as any other laws of nature are observed unchanged in each frame independent of their relative motion. The concept of inertial frame is derived from kinematic assumptions. Problems with inertial frames are met mainly in dynamics. In Newtonian mechanics momentum is directly proportional to the velocity which means that a change in momentum is not a problem in a transformation from one inertial frame to another frame. Kinetic energy, however, is proportional to the second power of velocity, which means that kinetic energy in one frame cannot be transformed to kinetic energy in another by using the Galilei transformation.

The Newtonian concept of reference frames and the Galilei transformation met problems with observations of electromagnetic radiation. The search for solution was activated in late 19<sup>th</sup> century by staying in the kinematic approach – which led to the replacement of the linear Galilei transformation with non-linear transformations. Consistency with Maxwell's equations and the best fit with observations were obtained with the Lorentz transformation. The special theory of relativity based on the relativity principle and the constancy of the velocity of light made the Lorentz transformation a law of nature.

### **The velocity of light**

The active development of natural sciences in the 17th century was completed by the indications of the finiteness of the velocity of light obtained by the Danish astronomer Ole Rømer (1644–1710), and the observations on Saturn's rings and the revolution of planets by the Italian-French astronomer Giovanni Cassini. Rømer had followed the moon of Jupiter Io for several months and noticed that the hiding of the moon behind Jupiter was delayed during the seasons when the Earth's distance to Jupiter was increasing, Figure 1-15. Rømer did not calculate the velocity of light from the observations, but based on his observations, Christiaan Huygens and several others derived an estimate of the velocity of light. Huygens's estimate for the propagation velocity of light was 16.67 Earth diameters per second, which corresponds to a velocity about 210 000 km/s. There was a lot of suspicion regarding Rømer's method until the English astronomer James Bradley, in 1730, confirmed Rømer's observations and the result regarding the velocity of light.

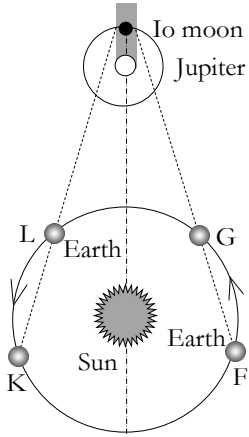

Figure 1-15 Determination of the velocity of light by observing the period of the moon of Jupiter Io. The illustration is reconstructed from the illustration in Rømer's paper (1676), in which he introduces the measurement of the velocity of light. Rømer compared the period of Io between points F and G, when the Earth approaches Jupiter and between point L and K when the Earth recedes from Jupiter.

## From Newtonian space to Einsteinian space

While focusing on the mechanics of the planetary system, Isaac Newton did not give much attention to the space behind the system. It was enough to assume that the solar system could be considered as an essentially independent system, which is at rest or in a linear motion in space.

In the mid 18<sup>th</sup> century, a comparison of the earliest and latest observations of the Moon and the planets indicated a growth in orbital velocities of the Moon and planet Jupiter, and a decrease in the orbital velocity of Saturn – which could be interpreted as a risk of forthcoming fall of the Moon to the Earth, fall of Jupiter to the Sun and escape of Saturn from the solar system. Upon an initiative by the French Academy of Sciences in 1748, Euler and Lagrange tried to solve the problem but without success. In 1776, Laplace studied the possibility that gravity is not an immediate effect but acts at a finite speed. Delayed gravity did not give the answer. Finally, Laplace found the explanation for the observations; they were due to periodic disturbances integrated from tiny third-order terms related to the planetary system – terms that Euler and Lagrange had ignored in their calculations.

Laplace showed also that the anomalies in the orbit of the Moon are due to disturbances in the orbit of the Earth due to other planets. In the case of Saturn and Jupiter, the observed anomalies were consequences of the interactions with other planets; Laplace was able to identify a long-term perturbation, with a period of 900 hundred years that explained, with high accuracy, the alarming behavior of Jupiter and Saturn in mid 18<sup>th</sup> century. Laplace's comprehensive book on celestial mechanics *Mécanique Céleste*<sup>29</sup>, which also summarized his predecessor's works, was published in 1799-1825.

An important choice that Laplace made in his calculations on celestial mechanics was the description of gravitational potential as a scalar field summed up from all masses in the system. The mathematical treatment of the potential field created the *Laplace equation*,  $\nabla^2 = 0$  or  $\Delta = 0$ , where  $\nabla^2$  (*nabla*<sup>2</sup>) or  $\Delta$  (*delta*) is referred to as the *Laplace operator*, or the *Laplacian*.

The spectacular contribution of French mathematicians in celestial mechanics was complemented by the work of Jean le Rond d'Alembert on the first practical model for the changes in the vernal and autumnal equinoxes. His solution, like the solution by Euler, omitted the effects of ocean currents. In fact, Laplace showed that the ocean currents do not affect the equinoxes. Altogether, the mathematical analyses by Laplace showed the amazing stability of the Earth and the solar system. Regarding the Earth he, for example, showed that if seawater had the density of mercury, the tides would make the sea rise up to the highest mountains.

In the 17<sup>th</sup> century, Edmond Halley had recognized that the accurate distance of the Sun from the Earth could be determined by utilizing the transit of Venus, passing the Sun between the Earth and the Sun. The measurement requires simultaneous observations on the Earth, at locations as far from each other as possible. This kind of measurement was performed in 1761 and 1769. The project was participated by

<sup>29</sup> Pierre-Simon Laplace, *Mécanique Céleste*, <http://www.archive.org/stream/mcaniquecles01laplrich>

the British navigator, Captain Cook on the Island of Tahiti, the Hungarian astronomer Maximilian Hell in Vardø in Norway, and astronomers in Philadelphia, in Hudson Bay in Canada, in Saint Dominique in Central America, in Baja California, in St. Helen Island, in Pondicherry in India, and at the Cape of Good Hope in South Africa. As a demonstration of the phenomenal mathematical intuition of Laplace, he was able to determine the distance of the Sun with the same accuracy using mathematical methods based on precise observations of the motions of the Moon obtained from a single observatory.

The precise picture and mathematical description of the solar system had a major impact on the general understanding of space. Also, it meant a new attitude in the study of space and celestial phenomena, and a critical attitude regarding the old conceptions inherited from antique religions. The sphere of the fixed stars was no longer static. In his work *Allgemeine Naturgeschichte und Theorie des Himmels*<sup>30</sup> (*General History of Nature and Theory of the Heavens*) in 1755, Immanuel Kant, by philosophical argumentation, presented a hypothesis according to which the Sun, the planets and even galaxies are formed by condensation of nebulae. Laplace presented his own hypothesis on nebulae in his book *Exposition du système du monde* (*The System of the World*)<sup>31</sup> in 1796. In his hypothesis he studies the formation of the solar system in a cooling, compressing gas disk.

Differential and integral calculus developed by Newton and Leibniz as well as Newton's laws of motion triggered a development that took mathematics and mathematical physics to a new level. The 18th century can be characterized as the century of mathematics. In addition to the huge development of mathematics, the next big step in the development of natural sciences was preceded by wide-ranging, empirical and theoretical work in different areas of physics in the early 19<sup>th</sup> century.

### Analytical mechanics

As illustrated by the chart in Figure 1-16, the interaction between mathematics and physics played an important role in the development. The paths of the further development of Newtonian mechanics led to analytical mechanics, statistical mechanics, and thermodynamics. A factor in common in all these developments was the recognition of the concept of energy and the conservation of energy as a primary law of nature. The concept of energy linked mechanics and thermodynamics to electromagnetism and electromagnetic radiation, which finally, in the late 19<sup>th</sup> century led to a re-evaluation of the scope of the Newtonian mechanics.

In spite of the fact that the concept of energy and its role as integrated force was unrecognized, hydrodynamics by the Swiss mathematician and physicist Daniel Bernoulli as well as the analytical mechanics by the mathematician and astronomer Joseph Lagrange included the conservation of energy as a central inherent property and principle.

---

<sup>30</sup> Immanuel Kant, *Allgemeine Naturgeschichte und Theorie des Himmels*, [www.archive.org](http://www.archive.org)

<sup>31</sup> Pierre-Simon Laplace, *Exposition du système du monde*, [www.archive.org](http://www.archive.org)

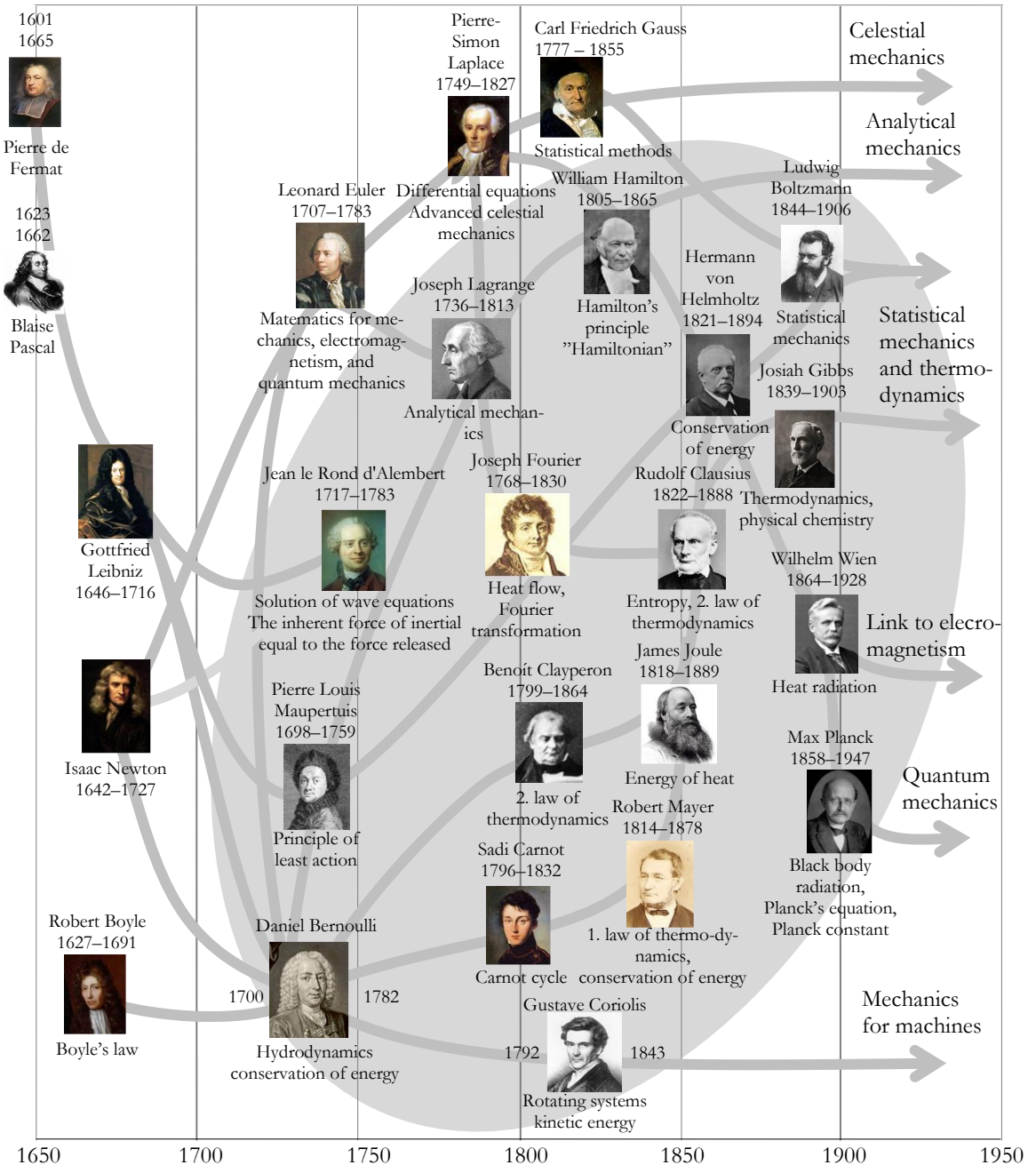

Figure 1-16. Development paths in post-Newtonian mechanics, and the diversification of the development paths into various fields of mechanics. The progress was guided by the impact of the development of mathematics in the 18th century and the activated empirical research in the early 19th century. Electromagnetism, as a new area of empirical physics, was linked to mechanics via the concepts of force and energy. The greyed ellipse in the background of the figure is to draw attention to the developments leading to the concept of energy and its conservation appearing as a basic law of nature.

*Lagrange formalism*

Like Euler, Lagrange was first of all a mathematician. The *Euler-Lagrange equation* derived using calculus of variations describes the path of least action for a physical phenomenon. The equation states that a change in momentum in a time differential is equal to the change in potential energy in a distance differential determined by the same time differential.

In Lagrange's equation of motion, the momentum is expressed as the partial velocity derivative of kinetic energy that applies in Newtonian mechanics but not for the momentum in special relativity

$$\frac{d}{dt} \frac{\partial L}{\partial \dot{q}_j} - \frac{\partial L}{\partial q_j} = 0 \quad (1.1)$$

The physical message of the equation can be interpreted as conservation of energy; in each time differential  $dt$  of the path the change in kinetic energy corresponding to change  $\partial \dot{q}$  in velocity is equal to the potential energy released in the corresponding distance differential  $\partial q$ .

Originally, the *Lagrangian*,  $L = T - U$ , which, using today's terms, is the difference between the kinetic energy and the potential energy, was introduced as an algebraic quantity. The physical meaning of the Lagrangian was recognized first after a better understanding of the concept of energy.

*Fermat's, Maupertuis's, and Hamilton's formalisms*

In the early 18<sup>th</sup> century, the French mathematician and multi-scientist Pierre Louis Maupertuis identified "*the easiest path*" or "*the path of least action*" as a guiding principle of physical phenomena. About one hundred years before Maupertuis, the French lawyer and amateur mathematician Pierre de Fermat had solved problems in optics by assuming that light chooses the quickest or optically shortest path from the source to the object.

Maupertuis, like Euler, defined the *local action* as the product of momentum and distance differential,  $mv \cdot ds$ . The expression of the total action from  $s_0$  to  $s_1$  obtains the form

$$S_{\text{Maupertuis}} \equiv \int_{s_0}^{s_1} mv \, ds \equiv \int_{q_0}^{q_1} p \, dq \quad (1.2)$$

where  $q$  is the generalized spatial coordinate.

If Maupertuis's distance differential  $ds$  is expressed in terms of the product of velocity and time differential,  $ds = v \cdot dt$ , we get the *temporary action*,  $dS = mv^2 \cdot dt = 2 \cdot (\text{classical kinetic energy}) \cdot dt$  that allows the expression of the total action from  $t_0$  to  $t_1$  as (in the framework of classical mechanics)

$$S_{\text{Maupertuis}} = \int_{t_0}^{t_1} mv^2 \, dt = \int_{t_0}^{t_1} 2 \cdot T \, dt \quad (1.3)$$

By replacing one of the kinetic energies in the integrand by the difference of total energy and the potential energy  $T = E - U$  we get

$$S_{Maupertuis} = \int_{t_0}^{t_1} (T + E - U) dt = E(t_1 - t_0) + \int_{t_0}^{t_1} (T - U) dt = E(t_1 - t_0) + \int_{t_0}^{t_1} L dt \quad (1.4)$$

that returns to sum of the product of total energy and time of the action, and time integral of the *Lagrangian*. The last term in the sum is *Hamilton's action integral*.

Hamilton's action integral is minimized when Lagrange's equation of motion applies

$$\frac{d}{dt} \frac{\partial L}{\partial \dot{q}_j} - \frac{\partial L}{\partial q_j} = 0 \quad (1.5)$$

Lagrange's equation is a re-formulation of Newton's second law. The partial derivative  $\partial L / \partial \dot{q}_j = \partial T / \partial \dot{q}_j$  means the momentum of the object. In Newtonian mechanics, the time derivative of momentum is equal to the product of mass and acceleration. The partial derivative  $\partial L / \partial q_j = -\partial U / \partial q_j$  means the negative of the gradient of potential energy, which is the force acting on the object.

Hamilton's function,  $H$ , which in classical mechanics means the total energy  $H = \sum p v_i - L = 2T - L = T + U$ , fulfills the differential equations

$$\frac{\partial H}{\partial q_k} = -\dot{p}_k \quad \text{and} \quad \frac{\partial H}{\partial p_k} = \dot{q}_k \quad (1.6)$$

Hamilton's equations (1.6) are not bound to classical mechanics; they apply also in the framework of special relativity, where Hamilton's function is expressed as the sum of kinetic energy and the potential energy as

$$H = mc^2 \left( \frac{1}{\sqrt{1 - (v/c)^2}} - 1 \right) + U = E_{kin} + U \quad (1.7)$$

Like Lagrange's mechanics, Hamilton's mechanics, introduced by the Irish mathematician, physicist and astronomer William Hamilton, is a formalism of classical mechanics expressed in terms of differential equations. Instead of Lagrange's second order differential equations, Hamilton's mechanics is expressed in terms of two first order differential equations. Lagrange's formalism applies generalized space and velocity coordinates, Hamilton's formalism adds generalized momenta (*conjugate momenta*). Unlike Lagrange's equation of motion, Hamilton's equations of motion apply also in the framework of the special theory of relativity.

### The principle of least action:

*As an integrated quantity, "action", shall not be regarded as a quantity guiding the motion locally or temporarily, but a quantity realized in motion guided by the equations of motion. In free interaction between potential and motion, we can identify a "tendency towards actualization", which means that the process converts as much potential into motion as possible and releases as little motion back to potential as possible.*



***A system shows a tendency towards the state of maximum energy of motion or, using Aristotle's expressions***

***In nature, there is a trend toward actualization of potentiality.***

## **Thermodynamics and statistical mechanics**

The development of thermodynamics was triggered by the need to improve the efficiency of the steam engine in the early 19<sup>th</sup> century. An important outcome from thermodynamics was its impact on the refinement of the concept of energy as a quantity in common in various physical and chemical processes. In his treatise *Reflexions sur la puissance motrice du feu et sur les machines développer propres à cette puissance* (*The Motive Power of Heat*<sup>32</sup>), in 1824, the French engineer Sadi Carnot introduced an ideal *Carnot cycle* where the heat, or more correctly, the temperature difference between heat contents was converted into mechanical work or, vice versa, mechanical work into a temperature difference. Implicitly, Carnot's theory included the conservation of energy in a closed system. However, the Carnot cycle did not clarify the central quantities in thermodynamics nor their mutual interactions.

In fact, the theoretical basis of thermodynamics was implicitly introduced as early as 1662 by Robert Boyle in Boyle's law, which defined the linkage between the volume and pressure of a gas in a closed system. Daniel Bernoulli, in his *Hydrodynamics*, published in 1738, developed the bases of the kinetic gas theory starting from Boyle's law. In the early 19<sup>th</sup> century Boyle's laws were complemented by *Gay-Lussac's* laws that related the temperature of the gas to its volume and pressure. Combination of the known gas laws into the *ideal gas law* was introduced in 1834 by the French engineer and physicist Benoît Clapeyron. In 1843, after a thorough study of the Carnot cycle, Clapeyron deduced the *Carnot principle* corresponding to the second law of thermodynamics.

A couple of years earlier, in 1841, the German physician and physicist Julius von Mayer had expressed the first law of thermodynamics, "*Energy can be neither created nor destroyed*". In his treatise *Die organische Bewegung im Zusammenhang mit dem Stoffwechsel* (*The Organic Movement in Connection with the Metabolism*), published in 1845, he specified the numerical value of the mechanical equivalent of heat as 4.17 J/cal, with only 0.4 % difference to its modern value 4.184 J/cal.

The English brewer and physicist, James Joule, who is generally recognized as the first to define of the mechanical equivalent of heat, used a falling mechanical weight to spin a paddle-wheel in an insulated barrel of water for converting the mechanical work into heat observed as a rise of the temperature of the water in the barrel. In another measurement he used electrical current in a resistor for heating water. With these experiments he obtained an estimate 4.14 J/cal for the mechanical equivalent of heat. By pressurizing gas, he obtained the value 4.43 J/cal. When referring to mechanical energy Joule used Leibniz's living force, *vis viva* ( $mv^2$ ). In his textbook *Calcul de l'Effet des Machines* (*Calculation of the Effect of Machines*), published in 1829, the French engineer, mathematician, and scientist Gustave Coriolis had added the factor

<sup>32</sup> Sadi Carnot, *The Motive Power of Heat*, <http://archive.org/stream/reflectionsonmot00carnrich>

$\frac{1}{2}$  to Leibniz's living force. The concept of kinetic energy, as  $\frac{1}{2}mv^2$ , was introduced in 1850 by the English physicist and engineer William Thomson, better known as Lord Kelvin.

In 1847, the German physician and physicist Hermann von Helmholtz made a clear statement on the conservation of energy as the first law of thermodynamics. In his treatise *Über die Erhaltung der Kraft (On the Conservation of Force)*<sup>33</sup> or in modern terms *On the Conservation of Energy*, Helmholtz analyses the mathematical bases of the conservation of energy. He uses both philosophical and physical arguments to justify the conservation of energy. Also, he refers to the works of Sadi Carnot, Benoît Clapeyron, Robert Mayer and James Joule. He concluded that anywhere where energy looks like diminishing, it is converted into heat. Further, in his 1847 work Helmholtz confirms that the energy  $\frac{1}{2}mv^2$  derived by Gustave Coriolis from central forces is the kinetic energy.

Formulation of the definitions of the basic quantities and the unification and compiling of the theory of thermodynamics was performed by the German mathematician and physicist Rudolf Clausius. In his book *Über die bewegende Kraft der Wärme*<sup>34</sup> (*On the Moving Force of Heat and the Laws of Heat which may be Deduced Therefrom*)<sup>35</sup> published in 1850, he formulates the second law of thermodynamics as the final replacement of the caloric theory dating back to the "father of modern chemistry" Antoine Lavoisier. In the caloric theory heat was considered as a light element or subtle fluid called *caloric*. When a body was cooling, caloric escaped from the body to the surroundings. As a part of Lavoisier's law of conservation of mass, the total amount of caloric was conserved in the universe.

Credit for the early recognition of heat as a manifestation of kinetic energy, *vis viva*, should probably be addressed to the American-born British physicist and inventor, Benjamin Thompson, who in 1797, based on his experiments with gunnery, showed that friction between pieces of metal results in heat generation. The term *energy* for Leibniz's *vis viva* may first have been used by Thomas Young in the beginning of the 19<sup>th</sup> century. The concept of energy, however, was fully outlined only when it was identified as a central attribute in mechanical motion, electromagnetism and heat content, and in the potential for creating those in gravitational and electromagnetic fields.

The ideal gas laws, the conception of heat as kinetic energy and the formulation of the general principles of thermodynamics created the basis for the development of statistical mechanics. The fundamental conception of statistical mechanics or statistical thermodynamics was carried out by the Austrian physicist Ludwig Boltzmann in the 1870s.

Boltzmann's approach gave strong support to the atomic theory which at that time still was in its infancy. The term "*statistical thermodynamics*" was introduced by the American chemist, physicist and mathematician Willard Josiah Gibbs in 1902.

<sup>33</sup> Hermann von Helmholtz, *On the Conservation of Force*, <http://www.bartleby.com/30/125.html>

<sup>34</sup> Rudolf Clausius, *Über die bewegende Kraft der Wärme*, <http://archive.org/stream/diemechanischew04claugoog>

<sup>35</sup> Phil. Mag. and Journal of Science, Vol.II, Jul-Dec, 1851 <http://archive.org/stream/londonedinburghd02lond>

In statistical thermodynamics the energy of a system is expressed in terms of the sum of the energies of individual particles in the system. According to the equipartition principle, the energy of the system is shared equally among the particles and their degrees of freedom in the system. In practice, the energy of particles follows the distribution determined by the nature of the system characterized by the available energy states and the degree of freedom. For example, the atoms of ideal gases have three degrees of freedom, the velocity components in  $x$ -,  $y$ -, and  $z$ -directions, the kinetic energy of which follows the *Maxwell-Boltzmann distribution*, originally derived by James Clerk Maxwell and later complemented by Ludwig Boltzmann. The *Maxwell-Boltzmann distribution* expresses the probability distribution of the kinetic energy of the particles at a specific temperature.

## Electromagnetism and the theory of light

### *From static electricity to electromagnetism*

As a phenomenon, static electricity has been known since ancient times, but the first quantitative measurements of the properties of static electricity were not made until the late 18<sup>th</sup> century, when the British scientists, Joseph Priestley and Henry Cavendish independently found that the force between electric charges was inversely proportional to the square of the distance between the charges.

In 1785, the French physicist Charles Coulomb described the electrostatic force as a force, which is directly proportional to the product of the charges and inversely proportional to the square of the distance between the charges. Henry Cavendish's notes from the year 1771 were found from the archives of the Royal Society by James Clerk Maxwell in 1878. In fact, Cavendish had not defined only the "Coulomb force" but also the concepts of resistance, electric potential, capacitance and dielectric constant.

The electrochemical cell or battery, invented and introduced by the Italian physicist Alessandro Volta in 1800, made it possible to carry out systematic studies on the properties of electricity. Characterization of electricity was a most demanding and diversified task. The linkage between electric current and magnetism was first observed by the Danish chemist and physicist Hans Christian Ørsted when he noticed that electric current affects the direction of a nearby compass needle. The French physicist and mathematician André-Marie Ampère continued Ørsted's studies and observed, that electric currents in parallel wires result in mechanical attraction or repulsion between the wires, depending on the mutual directions of the currents. Ohm's law, that expresses the electric resistance of a conductor as the ratio between the voltage and the current, was independently established by the German physicist and mathematician Georg Ohm in 1827.

The practically self-taught British polymath scientist Michael Faraday was perhaps the most successful experimentalist in characterizing the properties of electricity. The electromagnetic induction he observed in 1831 made it possible to construct generators, electric motors, and transformers, Figure 1-17. The mathematical description of the electromagnetic force was first introduced by the German physicist

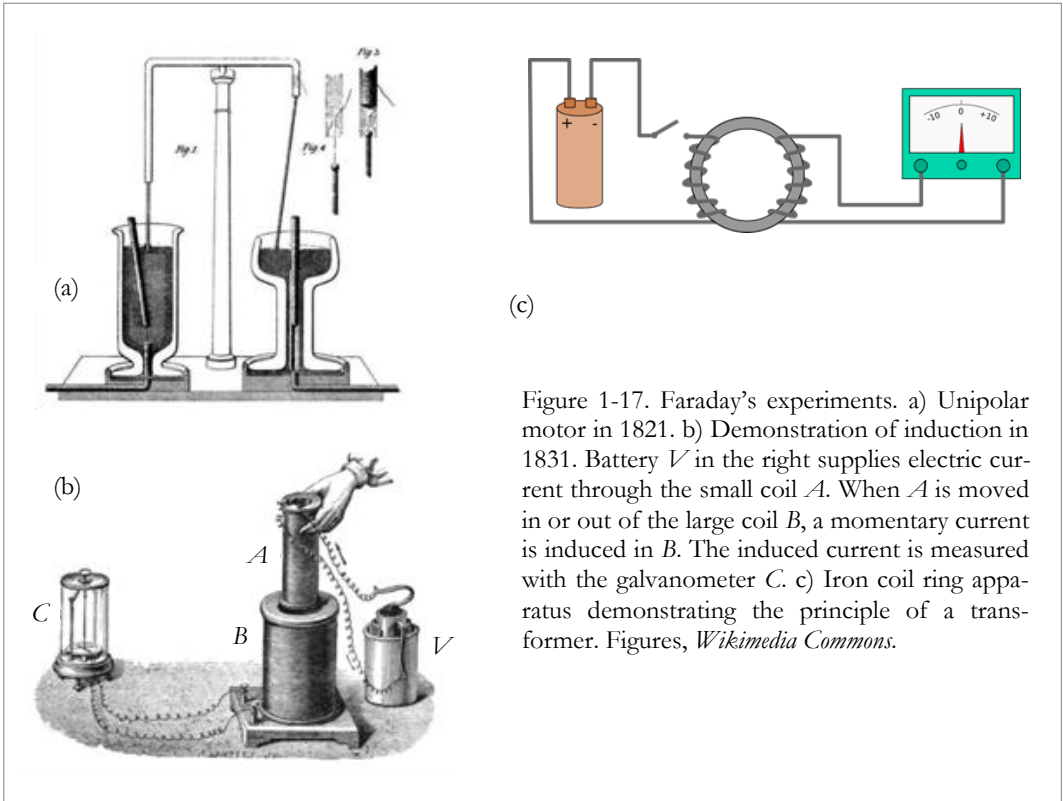

Figure 1-17. Faraday's experiments. a) Unipolar motor in 1821. b) Demonstration of induction in 1831. Battery  $V$  in the right supplies electric current through the small coil  $A$ . When  $A$  is moved in or out of the large coil  $B$ , a momentary current is induced in  $B$ . The induced current is measured with the galvanometer  $C$ . c) Iron coil ring apparatus demonstrating the principle of a transformer. Figures, *Wikimedia Commons*.

Wilhelm Weber in 1846. It expressed the force between electric charges in terms of static and dynamic components. Electromagnetic induction and the electric motors and generators linked electric quantities to mechanical work and thereby to the concept of energy. Heat generated in electric conductors or resistors linked electric units to the quantities characterizing heat.

#### *From light to electromagnetic radiation*

The scientific characterization of light started to emerge with the wave theory of light introduced by the Dutch physicist Christiaan Huygens in the late 17<sup>th</sup> century for explaining the double reflection and interference phenomena. Similar ideas were also presented by the English polymath scientist Robert Hooke.

Huygen's and Hooke's wave theories were shadowed for a long time by Newton's corpuscular theory of light. The corpuscular theory was further studied and developed in the late 18<sup>th</sup> century by the excellent mathematicians, Pierre-Simon Laplace and Siméon-Denis Poisson. The wave theory was re-awakened by the English polymath Thomas Young in his talk in the Royal Society in 1803. The talk, entitled *Experimental Demonstration of the General Law of the Interference of Light*, was published in *Philosophical Transactions of the Royal Society* in 1804<sup>36</sup>.

<sup>36</sup> [Philosophical Transactions of the Royal Society of London](#) 94

Young's work on the wave theory of light was complemented by the French engineer *Augustin-Jean Fresnel* who performed numerous experiments and showed, for example, that light was best represented as a transverse wave. In the early 19<sup>th</sup> century, there were intense debates between the supporters of the wave theory and corpuscular theory of light in the French Academy of Sciences. These debates ended with the wave theory as the winner. Fresnel got strong supporters and collaborators for further research, among them were the secretary of the Academy, the mathematician François Arago and the physicist and mathematician André-Marie Ampère who is better known from his contribution to electromagnetism.

In 1845, Michael Faraday demonstrated the effect of a magnetic field on the polarization plane of light, Figure 1-18. Further indication of the connection between electromagnetism and light was obtained when Wilhelm Weber, in 1850s, concluded that the inverse square root of the product of the electric and magnetic constants  $\epsilon_0$  and  $\mu_0$  has the dimension of velocity and a numerical value essentially equal to the known velocity of light,  $1/\sqrt{\epsilon_0\mu_0} \approx 300\,000 \text{ [km/s]} \approx c$ .

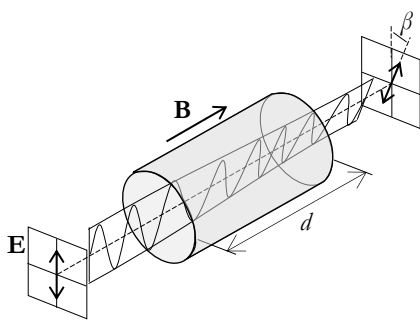

Figure 1-18. Faraday rotation describes the effect of a magnetic field on the plane of polarization of light. The rotation of the plane of polarization is linearly proportional to the magnetic field in the direction of the propagation of light.

The effect has technical use in optoelectronics components. The effect can also be utilized, for example, in the measurement of the effects of the ionosphere and the magnetic field of the Earth on the electromagnetic radiation from space.

Figure, *Wikimedia Commons*.

### *Maxwell's equations*

The experimental findings and theoretical considerations of electromagnetism in the first half of the 19<sup>th</sup> century were collected into a unified formalism by the Scottish physicist and mathematician James Clerk Maxwell. *Maxwell's equations* are a set of partial differential equations that, together with the Lorentz force, form the foundation of classical electrodynamics and the basis of modern electrical engineering.

In his publication *On Physical Lines of Force* or (as entitled by the Cambridge Philosophical Society) *On Faraday's Lines of Force*<sup>37</sup> in 1861, Maxwell analyses Faraday's observations on electromagnetic induction and concludes that they are consistent, for example, with Poisson's equations. Maxwell tried to find a mechanical analogy to help the understanding of the experimental findings. He compared the behavior of electromagnetism to the motion of an incompressible inertia-free fluid, which is resisted by a retarding force proportional to the velocity. Maxwell concluded that

<sup>37</sup> J. Maxwell, *On Faraday's Lines of Force*, [The Scientific Papers of James Clerk Maxwell](#), p. 155-229

the laws found by Ampère, were identical with Faraday's laws. He proposed that the source of a magnetic field can be described in terms of microscopic current loops.

Maxwell's equations are presented in Maxwell's treatise *A Dynamical Theory of the Electromagnetic Field*<sup>38</sup> published in 1864. He starts the treatise with Introduction (Citation from Wikisource):

*(1) The most obvious mechanical phenomenon in electrical and magnetical experiments is the mutual action by which bodies in certain states set each other in motion while still at a sensible distance from each other. The first step, therefore, in reducing these phenomena into scientific form, is to ascertain the magnitude and direction of the force acting between the bodies, and when it is found that this force depends in a certain way upon the relative position of the bodies and on their electric or magnetic condition, it seems at first sight natural to explain the facts by assuming the existence of something either at rest or in motion in each body, constituting its electric or magnetic state, and capable of acting at a distance according to mathematical laws.*

*In this way mathematical theories of static electricity, of magnetism, of the mechanical action between conductors carrying currents, and of the induction of currents have been formed. In these theories the force acting between the two bodies is treated with reference only to the condition of the bodies and their relative position, and without any express consideration of the surrounding medium.*

*These theories assume, more or less explicitly, the existence of substances the particles of which have the property of acting on one another at a distance by attraction or repulsion. The most complete development of a theory of this kind is that of M.W. Weber, who has made the same theory include electrostatic and electromagnetic phenomena.*

*In doing so, however, he has found it necessary to assume that the force between two particles depends on their relative velocity, as well as on their distance.*

*This theory, as developed by M. W. Weber and C. Neumann, is exceedingly ingenious, and wonderfully comprehensive in its application to the phenomena of static electricity, electromagnetic attractions, induction of current and diamagnetic phenomena; and it comes to us with the more authority, as it has served to guide the speculations of one who has made so great an advance in the practical part of electric science, both by introducing a consistent system of units in electrical measurement, and by actually determining electric quantities with an accuracy hitherto unknown.*

*(2) The mechanical difficulties, however, which are involved in the assumption of particles acting at a distance with forces which depend on their velocities are such as to prevent me from considering this theory as an ultimate one though it may have been, and may yet be useful in leading to the coordination of phenomena.*

*I have therefore preferred to seek an explanation of the fact in another direction, by supposing them to be produced by actions which go on in the surrounding medium as well as in the excited bodies, and endeavouring to explain the action between distant bodies without assuming the existence of forces capable of acting directly at sensible distances.*

*(3) The theory I propose may therefore be called a theory of the Electromagnetic Field, because it has to do with the space in the neighbourhood of the electric or magnetic bodies, and it may be called*

---

<sup>38</sup> J. Maxwell, *A Dynamical Theory ...*, [http://en.wikisource.org/wiki/A\\_Dynamical\\_Theory\\_of\\_the\\_Electromagnetic\\_Field](http://en.wikisource.org/wiki/A_Dynamical_Theory_of_the_Electromagnetic_Field)

*a Dynamical Theory, because it assumes that in that space there is matter in motion, by which the observed electromagnetic phenomena are produced.*

(4) *The electromagnetic field is that part of space which contains and surrounds bodies in electric or magnetic conditions . . .*

Maxwell continues with a statement that the space filled with a medium may contain material or it may be a vacuum and names the medium for electromagnetism as *aether*. The propagation of light and heat in aether shows, that aether may penetrate through transparent materials. He concludes that the energy of light and heat propagating in the aether is shared equally to the motion and the elastic tension of the aether.

(6) *... The medium is therefore capable of receiving and storing up two kinds of energy, namely, the "actual" energy depending on the motions of its parts, and "potential" energy, consisting of the work which the medium will do in recovering from displacement in virtue of its elasticity...*

When describing the properties of the *ethereal medium* Maxwell states, among other things, the rotation of the polarization plane due to magnetic field, and the effects of paramagnetic and diamagnetic materials on the polarization, observed by the French physicist Émile Verdet. Maxwell defines the concept of electromotive force that generates an electric current in a conductor and polarization in a dielectric material. Polarization directs the molecules in dielectric materials in a similar way as a magnet directs the molecules in paramagnetic materials.

The central message of Maxwell's equations is in the presence of an electromagnetic field. For justifying the presence of the fields, he introduced the *aether* that stores the energy either as the energy of motion or the energy of compression. "*In speaking of the Energy of the field, however, I wish to be understood literally. All energy is the same as mechanical energy, whether it exists in the form of motion or in that of elasticity, or in any other form*"<sup>39</sup>.

An essential difference between Maxwell's theory and Weber's theory is the mechanism of electromagnetic action at distance. In Maxwell's theory the action is transferred by the electromagnetic field in the aether – in Weber's theory action occurs as a direct action at distance between charges and electric currents. Combining the interactions between electric and magnetic fields, Maxwell derives a wave equation that describes the propagation of an electromagnetic wave at a specific velocity in the aether. The velocity is determined, as expressed by Maxwell, "*by the electric elasticity of the medium, determined experimentally by Weber and Kohlrausch*"<sup>40</sup>.

Maxwell's electromagnetic field is a potential field in the aether. The electrostatic component of the field corresponds to Laplace's scalar gravitational field of gravitational potential. Accordingly, electrostatic force appears as the gradient of the potential field. The magnetic component of the field is a rotating field exciting the magnetic force. He concludes that if the magnetic state of the field depends on the motion of the medium, a force is needed for increasing or diminishing the motion. The rotating field serves as a flywheel for the electric current.

<sup>39</sup> J.C. Maxwell, [A Dynamical Theory of the Electromagnetic Field, Part I \(19\)](#), Wikisource.org

<sup>40</sup> J.C. Maxwell, [A Dynamical Theory of the Electromagnetic Field, Part I \(19\)](#), Wikisource.org

Maxwell finalized and presented his theories on electromagnetism in the book *A Treatise on Electricity and Magnetism*<sup>41</sup>, published in 1873. *Maxwell's equations* consisted of twenty equations that defined the electromagnetic fields and the corresponding interactions of the fields on electric charges and their motions. Maxwell may be the first in a systematical use of dimensional analysis in the study of the nature of physical quantities, although the importance of the dimensional analysis had been presented earlier by Joseph Fourier in his book *Théorie analytique de la chaleur* (*The Analytic Theory of heat*) published in 1822.

In the summary of his book *A treatise on electricity and magnetism* Maxwell discusses the action at a distance and the necessity of a propagation medium:

*"...In fact, whenever energy is transmitted from one body to another in time, there must be a medium or substance in which the energy exists after it leaves one body and before it reaches the other, for energy, as Torricelli remarked, is a quintessence of so subtle a nature that it cannot be contained in any vessel except the inmost substance of material things. Hence all these theories lead to the conception of a medium in which the propagation takes place, and if we admit this medium as an hypothesis, I think it ought to occupy a prominent place in our investigations, and that we ought to endeavour to construct a mental representation of all the details of its action, and this has been my constant aim in this treatise".*

The modern form of Maxwell's equations was developed by the English electrical engineer, mathematician and physicist Oliver Heaviside in 1884. Heaviside's formalism is based on four partial differential equations, where the basic quantities are the electric and magnetic vector fields as force fields. He converted Maxwell's scalar potential fields into vector fields describing the local gradients of the scalar fields. The vector field formalism simplified the mathematical expressions significantly – philosophically it returned the Newtonian hierarchy with force as the primary physical quantity before energy.

Maxwell's equations show the connection between oscillating charges and an electromagnetic wave propagating in space – which meant the possibility of transmitting and receiving electromagnetic radiation. Maxwell's equations cover widely the needs in radio engineering and antenna theory.

Figure 1-19 illustrates the development paths from early wave theory of light and experimental observations of electricity and magnetism to Maxwell's equations and the demonstration of electromagnetic radiation.

### *Energy and the conservation laws*

Newtonian mechanics with its force-based approach dominated physical thinking for two hundred years, which might have contributed to the difficulty in the conception of energy. Energy as integrated force and the work done, found its place as a fundamental physical quantity and main conservable first with the development of thermodynamics in the late 19<sup>th</sup> century.

---

<sup>41</sup> J C Maxwell, *A treatise on electricity and magnetism* (1873), [http://en.wikisource.org/wiki/A\\_Treatise\\_on\\_Electricity\\_and\\_Magnetism](http://en.wikisource.org/wiki/A_Treatise_on_Electricity_and_Magnetism)



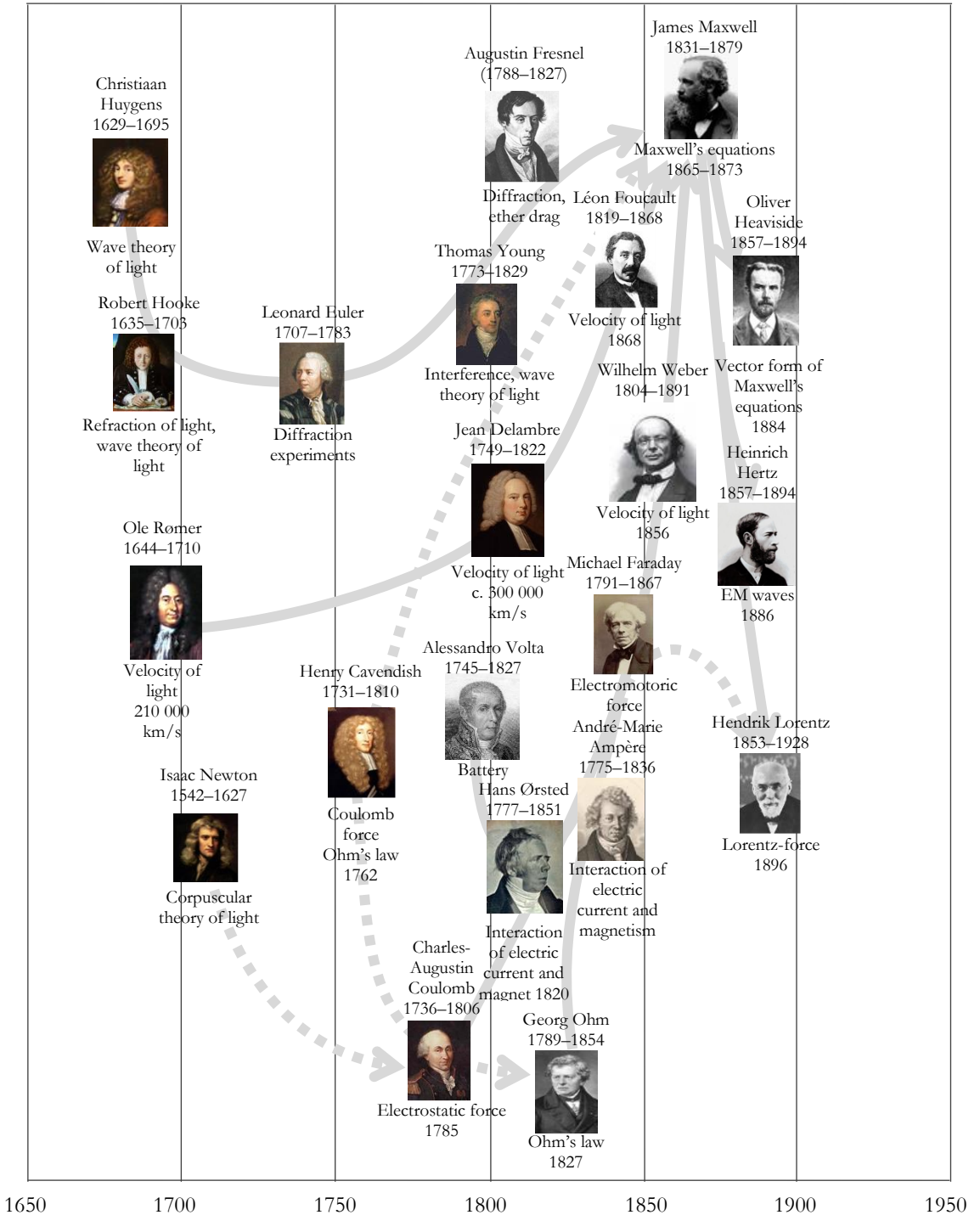

Figure 1-19. Development paths of the theories of light, the velocity of light, electromagnetism and electromagnetic radiation.

The parallel development of thermodynamics, electromagnetism, and physical chemistry had an important role in the refinement of the concept of energy and the recognition of energy as a unifying quantity between different areas of physics, as well as between physics and chemistry. In the late 19<sup>th</sup> century, the general atmosphere had matured to a principal discussion on the roles of matter and energy as the main substance – in thermodynamics energy had been identified as the main conservative and the conservation of energy as a fundamental law of nature. Conservation of mass in chemical reactions had been identified by the French chemist Antoine Lavoisier one hundred years earlier.

In the late 19<sup>th</sup> century, also the essence of matter was under active discussion. Several philosophers and some physicists like the Austrian Ernst Mach, opposed atomism in spite of the fact that Ludvig Boltzmann had succeeded in combining atomistic ideas with a more holistic statistical approach that could be mathematically described in terms of differential equations, much like in the case of continuous matter.

In his book *Science and Hypothesis*, Chapter VIII <sup>42</sup> (1902) Henri Poincaré describes the concept of energetics in the late 19<sup>th</sup> century:

*“The difficulties raised by classical mechanics have led certain minds to prefer a new system which they call Energetics. Energetics took its rise in consequence of the discovery of the principle of the conservation of energy. Helmholtz gave it its definite form. We begin by defining two quantities which play a fundamental role in this theory. They are **kinetic energy**, or vis viva, and **potential energy**. Every change that the bodies of nature can undergo is regulated by two experimental laws. First, the sum of the kinetic and potential energies is constant. This is the principle of the conservation of energy. Second, if a system of bodies is at A at the time  $t_0$ , and at B at the time  $t_1$ , it always passes from the first position to the second by such a path that the **mean** value of the difference between the two epochs  $t_0$  and  $t_1$  is a minimum. This is Hamilton principle, and is one of the forms of the principle of least action”.*

<sup>42</sup> Henri Poincaré, *Science and Hypothesis*, <http://archive.org/stream/sciencehypothesis00poin>

## From Maxwell's equations to the theory of relativity

### *Electromagnetic radiation*

Empirical study of the electromagnetic waves predicted by Maxwell's equations were started by experiments carried out by the German physicist Heinrich Hertz in 1886. Hertz generated electromagnetic waves with a transmitter formed by an induction coil driving a parallel spark gap capacitor formed by two spherical electrodes with one meter feeding wires as antenna. The receiver was a wire coil terminated with spark electrodes. A spark burst in the transmitter resulted in a spark burst in the receiver at a few meters' distance, which indicated action at a distance and the existence of electromagnetic waves, Figure 1-20.

For Hertz, the success in the experiment meant mainly proof of Maxwell's theory. When performing the experiment, he did not yet see the future importance of radio waves<sup>43</sup>. Not only the generation and receiving of electromagnetic waves, but also the transmission medium, aether, and its physical characterization were under intensive discussions. Like Newton's laws of motion, Maxwell's equations implicitly assume a state of rest as a reference for the motion of electric charges and for the velocity of the propagating radiation generated.

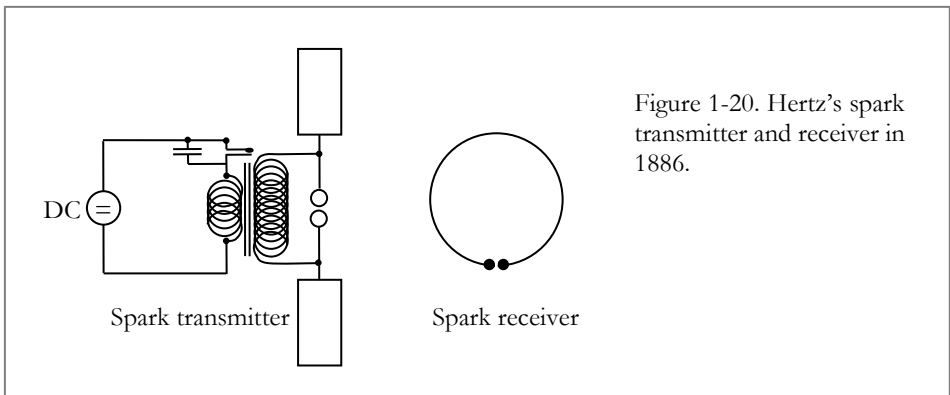

Figure 1-20. Hertz's spark transmitter and receiver in 1886.

### *Black body radiation*

The development of the theory of black body radiation appeared as a challenging but rewarding task where statistical thermodynamics and Maxwell's equations should be merged. The concept and definition of a black body was presented by the German physicist Gustav Kirchhoff in 1862. He describes an ideal black body as a closed box with a small hole for observation. The first step towards the theory of a black body was the radiation law presented by Josef Stefan in 1879. According to Stefan's empirical radiation law the radiation power emitted by a black body is proportional to the fourth power of the temperature of the emitting surface,  $P = \rho T^4$ .

<sup>43</sup> Heinrich Hertz, Untersuchungen über die Ausbreitung der Electricischen Kraft", [Open library, Electric Waves, 1893](#)

In 1884, the English physicist John Henry Poynting, starting from Maxwell's equations, showed that the energy of electromagnetic radiation can be expressed as the product of its momentum and velocity. Then, also the energy density and radiation pressure inside a black body cavity can be determined. Applying Poynting's results and his own studies in statistical thermodynamics, Ludwig Boltzmann showed the theoretical basis of Stefan's radiation law.

In 1893, following the thermodynamic procedure of Boltzmann, the German physicist Wilhelm Wien presented *Wien's displacement law* which expresses the temperature dependence of blackbody radiation. According to Wien's radiation law, the maximum of the emitted radiation occurs at a frequency which is directly proportional to the temperature,  $f_{\max} \sim T$ .

In 1894, Wien presented a prediction for the spectrum of black body radiation

$$\rho(f) = a f^3 e^{-\beta f/T} \quad (1.8)$$

which gave a nice fit to observed spectra at frequencies above the maximum of radiation. At lower frequencies the power density, however, did not follow Wien's prediction; instead of being proportional to the third power of the temperature it seemed to be proportional to the second power of the temperature. The lower end of the spectrum followed the prediction presented by the English physicist Lord Rayleigh. The derivation of Rayleigh's prediction was based on standing waves and their harmonics in a black body cavity. Because the number of waves increases without limits with the increasing frequency, the predicted radiation power also increased without a limit – a property, that later was referred to as the ultraviolet catastrophe.

The solution to the black body spectrum was introduced by the German physicist Max Planck in 1900. He described the emitters and absorbers on black body walls as monochromatic oscillators. The different behavior of the low-end and high-end part of the spectrum was explained when a single oscillator is assumed to send energy packets that are directly proportional to the frequency of the oscillator. In mathematical terms this means the famous *Planck's equation*

$$E = h \cdot f \quad (1.9)$$

where the proportionality factor  $h$  is the Planck constant.

To his great disappointment, Planck did not find theoretical support for his equation from Maxwell's equations that he highly respected. Accordingly, he had to introduce the equation  $E = hf$  as a postulate, or an *ad hoc* finding that probably reflected a still unknown law of nature (see Chapter 2 equation 2.5). Planck's prediction for the black body spectrum met Rayleigh's prediction at low frequencies and Wien's prediction at high frequencies – and agreed with the observations with outstanding accuracy at all applicable temperatures, Figure 1-21.

The excellent agreement of Planck's black body prediction made the Planck equation,  $E = hf$ , a generally accepted law of nature. It also triggered a search for the physical basis of the equation. Planck himself was quite reserved about his *ad hoc* equation. First, years later, when the equation was widely accepted and praised, Planck became convinced that he made an important contribution to physics.

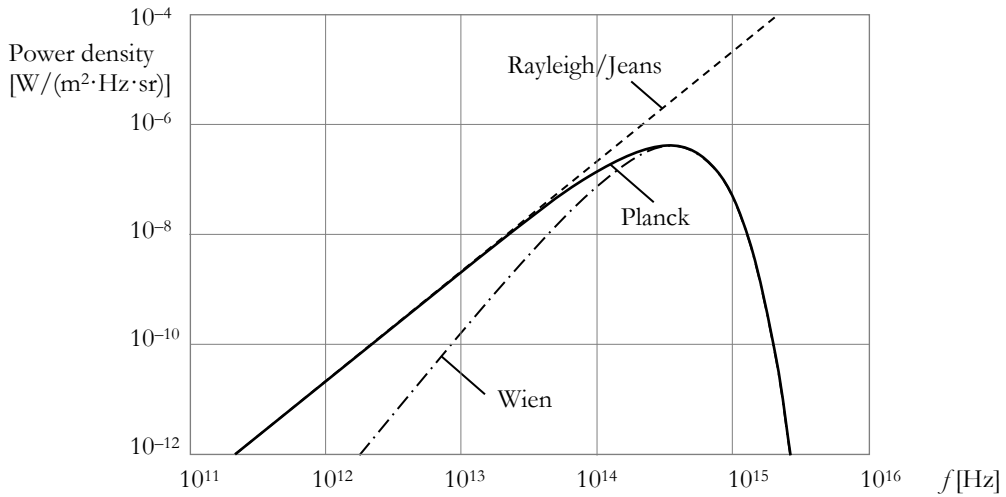

Figure 1-21. Comparison of the radiation spectra by Wien, Rayleigh and Planck for a black body at the temperature of 5778 K. Observations follow the Planck curve with high accuracy.

### *The velocity of light*

The finiteness of the velocity of light was known already at Newton's time. The first measurement of the velocity of light had been performed by Ole Rømer in 1676 by observing the changes in the period of the Io moon of Jupiter. The estimate for the velocity of light based on Rømer's observations was about 210 000 km/s. In 1809, the French mathematician and astronomer Jean Delambre repeated Rømer's measurements and obtained the estimate 296 000 km/s, which is quite close to the modern value for the velocity of light. The first terrestrial measurement was carried out by the French physicists Léon Foucault and Hippolyte Fizeau in 1850. The measurement system they used consisted of a light source, a fixed and a rotating mirror and a screen, for observing the displacement of the light beam due to the rotation of the mirror, Figure 1-22.

Foucault's and Hippolyte's estimate for the velocity of light was 298 000 km/s. The American physicist Albert Michelson repeated Foucault's and Fizeau's measurement with a more advanced apparatus and ended up with the value  $299\,864 \pm 51$  km/s. The presently accepted value for the velocity of light is 299 792.458 km/s, which is a defined precise value determining the standards for a second and a meter.

In the late 19th century, especially after Hertz's experiments, it was generally expected that the transmission medium, aether, creates a universal reference to the velocity of light – which was assumed to mean that the velocity of an observation frame relative to the aether should sum up to the velocity of the light observed. Accordingly, the rotational velocity of the Earth, from zero to 460 m/s, depending on the latitude, as well as the orbital velocity, about 30 km/s, of the Earth around

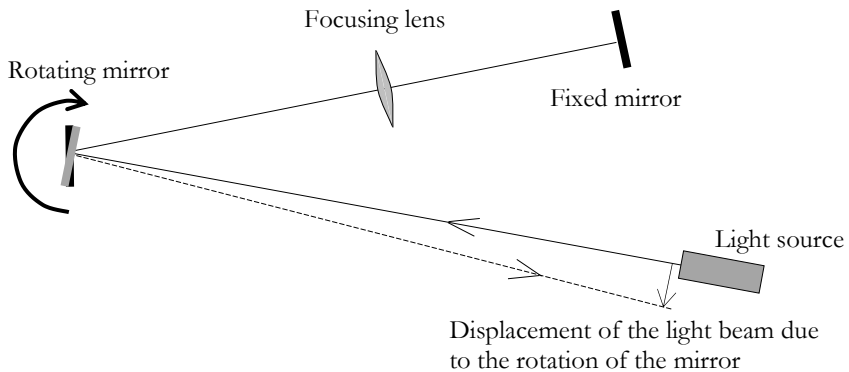

Figure 1-22 Apparatus used by Léon Foucault and Hippolyte Fizeau for the determination of the velocity of light in 1850. Albert Michelson's apparatus, in 1883, applied the same principle of operation. He obtained the value of  $299,864 \pm 51$  km/s for the velocity of light.

the Sun, should sum up to the velocity of light in the world aether. The velocity of the solar system in the Milky Way galaxy was not known in the late 19th century.

The most famous experiment for observing the world aether is the interferometric experiment carried out by Albert Michelson with his coworker Edward Morley in 1887. The experiment did not show any effect of the velocity of the Earth relative to the expected world aether. The interferometer used by Michelson and Morley applied a semitransparent mirror for splitting the light beam from a source into two beams directed to paths perpendicular to each other. Re-uniting of the two beams to a detector in common allowed observation of a possible phase difference created by the assumed difference in the velocities of the two beams due to their different orientation to the velocity of the interferometer relative to the world aether. For searching the phase shift the interferometer was rotated in relation to the assumed direction of the Earth's velocity<sup>44</sup>, Figure 1-23.

In principle, Michelson's and Morley's interferometer was accurate enough to detect the expected phase shift due the orbital velocity of the Earth. In spite of many careful attempts no phase shift was detected. The conclusion was that either the whole aether theory should be neglected or there should be a mechanism for local aether. The result was surprising also regarding the frame dragging experiments carried out by the French physicist Hippolyte Fizeau with flowing water in 1851<sup>45</sup>.

Michelson's first interpretation of the zero result in the experiment was the existence of "local aether" linked to the rotation of the Earth as proposed by the English mathematician and physicist George Stokes in 1845 – in spite of the fact, that, for

<sup>44</sup> A.A. Michelson, E.W. Morley, *On the Relative Motion of the Earth and the Luminiferous Ether*, American Journal of Science, 1887, **34** (203): 333–345, <https://history.aip.org/history/exhibits/gap/Michelson/Michelson.html#michelson1>

<sup>45</sup> Hippolyte Fizeau, Hypotheses on luminous ether and on an experiment that appears to demonstrate that the motion of bodies changes the velocity with which light propagates in their interior (1859), [wikisource.org](https://www.wikisource.org/wiki/Hippolyte_Fizeau/Hypotheses_on_luminous_ether_and_on_an_experiment_that_appears_to_demonstrate_that_the_motion_of_bodies_changes_the_velocity_with_which_light_propagates_in_their_interior)

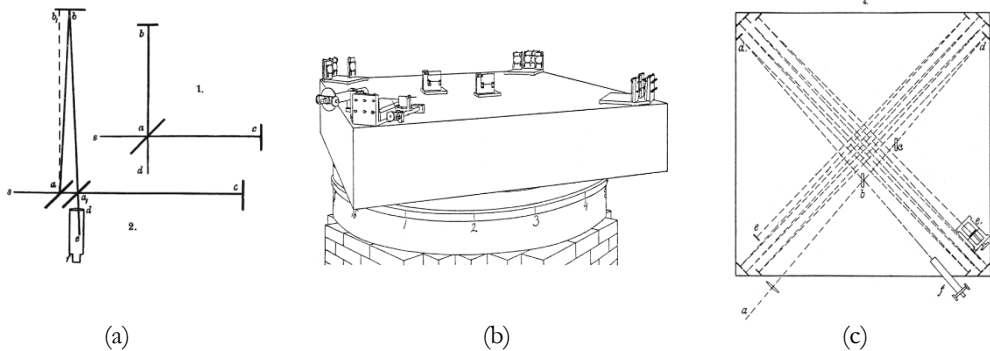

Figure 1-23. Interferometer used by Michelson and Morley for testing the aether theories. (a) Schematic presentation of the operational principle of the interferometer: Light beam from source  $s$  is split into orthogonal beams by semitransparent mirror  $a$ , one of the beams is directed to mirror  $b$  and the other to mirror  $c$ . Both beams are then directed to telescope  $f$ . In its initial state, the beam in path  $a-c-a$  propagates back and forth in the direction of the assumed velocity of the interferometer relative to the aether, and in the path  $a-b-a$  perpendicular the velocity of the interferometer. When the interferometer is rotated the situation is changed, which should be observed as a change in the phase shift between the two beams – assuming that the velocity of the interferometer is added to the velocity of light in the aether. (b) The interferometer was constructed on a 30 cm thick, 1.5 m<sup>2</sup> stone table, which could be rotated in the horizontal plane. (c) For improving the sensitivity of the instrument, the propagation paths of the beams were extended by reflecting the beam back and forth in each branch.

example, Henrik Lorentz had found contradictions in Stoke's explanation of aberration in the local aether.

Implicitly, Maxwell's theory assumes a propagation medium, aether, at rest. In principle, a Maxwellian radiation source in motion is subject to the *Doppler effect*, introduced by the Austrian mathematician and physicist Christian Doppler in 1846. In his paper *Über das farbige Licht der Doppelsterne und einiger anderer Gestirne des Himmels – Versuch einer das Bradley'sche Aberrations – Theorem als integrierenden Theil in sich schliessenden allgemeineren* (On the coloured light of the binary stars and some other stars of the heavens - Attempt at a general theory including Bradley's theorem as an integral part <sup>46</sup>) Christian Doppler derived the effects of the motion of the source and the receiver on the frequency and wavelength of radiation propagating in a medium at rest.

In 1887, starting from the analysis of the Doppler effect, the German physicist Woldemar Voigt presented a coordinate transformation that conserved the local velocity of light in a coordinate system in motion relative to the propagation medium <sup>47</sup>. Voigt's transformation conserved the traditional Galilei transformation of the spatial coordinate in the direction of motion, transformed, by the factor  $\sqrt{1 - (v/c)^2}$ , the coordinates perpendicular to the motion, and dilated time by the factor  $[1 - (v/c)^2]$ . By dividing the transformation formulas for both the spatial

<sup>46</sup> [http://en.wikipedia.org/wiki/%C3%9Cber\\_das\\_farbige\\_Licht\\_der\\_Doppelsterne\\_und\\_einiger\\_anderer\\_Gestirne\\_des\\_Himmels](http://en.wikipedia.org/wiki/%C3%9Cber_das_farbige_Licht_der_Doppelsterne_und_einiger_anderer_Gestirne_des_Himmels)

<sup>47</sup> W. Voigt, *On the Principle of Doppler*, <http://en.wikisource.org/?curid=674876>

coordinates and time by the factor  $\sqrt{1-(v/c)^2}$ , the Voigt transformation converts into the Lorentz transformation used in the special theory of relativity. Voigt's transformation was based on an analysis of the Doppler effect in an elastic medium – the conservation of the local velocity of light in reference frames in relative motion was a consequence of the properties he assumed for the medium. In principle, Voigt's transformation was enough to explain the Michelson–Morley experiment although he did not make a reference to that in his papers.

The first, to give a possible explanation to the Michelson–Morley experiment, was the Irish physicist and mathematician George FitzGerald in 1889. He noticed that the phase shift between the beams disappears if we assume that the velocity of the interferometer results in a contraction of the distance travelled by the light in the direction of the motion – such a contraction could occur if material is shrunk by the factor  $[1-1/2v/c]$  in the direction of motion.

In order to conserve the velocity of light in all directions in a reference frame in motion, we have to assume that length contraction is accompanied by time dilation. In 1890s, such transformations were developed by the Dutch physicist Hendrik Lorentz and the Irish physicist Joseph Larmor. Joseph Larmor pondered on the relations between the Michelson–Morley experiment and Fizeau's experiment as well as the Doppler effect and aberration. He concluded that aether moving with the Earth is in conflict with the aberration of light from stars. For explaining the Michelson–Morley experiment without fixing the aether to the Earth, Larmor developed a coordinate transformation that makes an observer moving in the aether to observe the light linked to his motion. Larmor's coordinate transformation was published in 1897 in *Philosophical Transactions of the Royal Society* and three years later in his book *Aether and Matter*<sup>48</sup> [p.38].

In his book, Larmor analyzes thoroughly the experiments by Fizeau and Michelson, as well as the Doppler effect, Maxwell's equations and the observations on aberration. As a conclusion, he ends up with a dynamic theory on the observation of electromagnetic radiation in moving media. According to Larmor's physical explanation, there is an actual contraction in material moving in aether [p. 64]. Larmor justifies his analysis with the hypothesis that an electron is a singularity of the aether, and that atoms are concentrations of such singularities. It turned out that Larmor's transformation appeared identical with the Lorentz transformation both regarding the length contraction and time dilation.

#### *Lorentz transformation*

In his treatise *De relatieve beweging van de aarde en den aether*<sup>49</sup> (*The Relative Motion of the Earth and the Aether*), published in 1892, Lorentz analyzes the conclusions drawn by Fresnel and Stokes regarding the aberration of star light and the motion of the Earth relative to the world aether; Fresnel assumed that the aether penetrates into all materials and that the motion of material bodies does not affect the aether – Stokes

<sup>48</sup> J. Larmor, *Aether and Matter*, <http://www.archive.org/stream/aethermatterdeve00larmuoft>

<sup>49</sup> Amsterdam, Zittingsverlag Akad. v. Wet., 1, p. 74, [wikisource.org](http://wikisource.org)



assumed that the aether is drawn by the motion of the Earth. After deriving a dragging coefficient corresponding to Fresnel's experimental formula, Lorentz rejects Stokes's model and accepts the Fresnel model which explained the Fizeau experiment with flowing water. The theory, however, was not enough to explain the Michelson–Morley experiment. *"I have sought a long time to explain this experiment without success, and eventually I found only one-way to reconcile the result with Fresnel's theory. It consists of the assumption, that the line joining two points of a solid body doesn't conserve its length, when it is once in motion parallel to the direction of motion of the Earth, and afterwards it is brought normal to it.... Such a change in length of the arms in Michelson's first experiment, and in the size of the stone plate in the second, is really not inconceivable as it seems to me"* [p.76].

Obviously, Lorentz arrived at the same conclusions as George FitzGerald. He justifies his conclusions concerning the molecular forces as *"...any cause that could modify it, could modify the shape and size as well... Since we know nothing about the nature of molecular forces, it is impossible to verify the hypothesis."*

In his paper *Versuch einer Theorie der electrischen und optischen Erscheinungen in bewegten Körpern* (*Attempt of a Theory of Electrical and Optical Phenomena in Moving Bodies* <sup>50</sup>, published in 1895, Lorentz introduces the concept of *local time* that together with length contraction conserves the velocity of light in moving reference frames. Applying the concept of local time, a local oscillator conserves its frequency with respect to the local time. He analyzes the effects of time dilation and length contraction in systems related to electromagnetic phenomena and the observation of the velocity of light, and shows, for example, that the derivation of the dragging coefficient corresponds to Fresnel's experimental equation.

In his paper *Simplified Theory of Electrical and Optical Phenomena in Moving Systems* <sup>51</sup> Lorentz collects his previous considerations, gives clear expressions to length contraction and time dilation, and confirms the concepts of local and universal time. In the final form, he published the transformations in 1904 in his paper *Electromagnetic phenomena in a system moving with any velocity smaller than that of light* <sup>52</sup> He saw the cause of the length contraction in the properties of electrons; he assumed that spherical electrons are flattened into ellipsoids with the semi-minor axis in the direction of the motion. Further, he concluded that the electromagnetic mass of electrons in the direction of motion is different from the electromagnetic mass perpendicular to the motion. Lorentz generalizes his conclusions on the mass and the form of electrons to any mass and macroscopic bodies [§12]. As a support to his conclusions he makes a reference to the measurement made by the German physicist Walter Kaufmann in 1902, and states that his prediction for the electron mass in the direction of motion coincides reasonably well with Kaufmann's observation. In his experiments with the cathode ray tube Walter Kaufmann had recognized the dependence of the electromagnetic mass of electron on the velocity by analyzing the ratio of the electric charge and mass – assuming the conservation of the charge.

In parallel with Lorentz's work, the French mathematician, physicist and philosopher Henri Poincaré studied the unified message of Maxwell's equations, Fizeau's

<sup>50</sup> E. J. Brill, Brill Academic Publishers, Leiden, [wikisource.org](https://www.wikisource.org)

<sup>51</sup> Proceedings of the Royal Netherlands Academy of Arts and Sciences, 1899 1: 427–442, [wikisource.org](https://www.wikisource.org)

<sup>52</sup> Proceedings of the Royal Netherlands Academy of Arts and Sciences, 1904, 6: 809–831, [wikisource.org](https://www.wikisource.org)

experiments, and the result of the Michelson–Morley experiment. In his paper *Sur la dynamique de l'électron* (*On the Dynamics of the Electron*) published in 1905, Poincaré discusses, for example, the absolute motion, length contraction and the velocity of the gravitational interaction<sup>53</sup>:

*"It seems at first sight that the aberration of light and the associated optical phenomena will provide a means of determining the absolute motion of the Earth, or rather its motion, not in relation to other stars, but in relation to the ether. This is not the case: the experiments in which we take into account only the first order of aberration were initially unsuccessful and an explanation was easily found; but Michelson, who imagined an experiment by which terms depending on the square of the aberration could be measured, had no luck either. It seems that this inability to demonstrate absolute motion is a general law of nature.*

*An explanation was proposed by Lorentz, who introduced the hypothesis of a contraction of all bodies in the direction of motion of the earth; this contraction would account for the Michelson-Morley experiment and all those that have been conducted to date, but leaves room for other experiments even more delicate and more easily conceived than executed, which might demonstrate the absolute motion of the Earth. But if the impossibility of such a finding is considered highly probable, one can predict that these experiments, if they can ever be conducted, will give a negative result.*

*Lorentz found it necessary to complete his hypothesis by assuming that all forces, whatever their origin, are affected by translation in the same way as electromagnetic forces and, consequently, the effect produced on their components by the Lorentz transformation is still defined by the corresponding equations.*

*It was important to examine this hypothesis more closely and in particular to examine what changes it would require us to make on the law of gravitation. That is what I sought to determine; I was first led to suppose that the propagation of gravitation is not instantaneous, but happens with the speed of light. This seems at odds with results obtained by Laplace, who announced that this propagation is, if not instantaneous, at least much faster than that of light. But in reality, the question posed by Laplace differs considerably from that which occupies us here. The introduction of a finite velocity of propagation was the only change Laplace introduced to Newton's law. Here, on the contrary, this change is accompanied by several others; it is possible, and that is indeed what happens, that a partial compensation occurs between them".*

In the last comment Poincaré accepts the finite velocity of gravitation, provided that the changes it causes in Newtonian gravitation become compensated by the further changes due to the Lorentz transformation. Further, Poincaré states that Lorentz's conclusions of the length contraction are valid if inertia is an electromagnetic effect as concluded from Kaufmann's experiments. Henri Poincaré saw, that the Lorentz transformation conserves the quantity  $ds^2 = x^2 + y^2 + z^2 - (ict)^2$  that can be interpreted as rotation in a four-dimensional space, where the fourth dimension is described as an imaginary direction  $ict$ <sup>54</sup>.

<sup>53</sup> H. Poincaré, *Science and Hypothesis*, [open library](#)

<sup>54</sup> E.T. Whittaker, *A History of the Theories of Aether and Electricity*, Dublin University Press Series (1910), [open library](#)

*The principle of relativity*

As already noticed by Galileo Galilei, the laws of mechanics seemed to be independent of the uniform motion of the observer; experiments with falling bodies in a moving ship gave exactly the same results as obtained when the ship is moored to a dock. The Michelson–Morley experiment indicated that the same could be true regarding experiments with light, and more generally, with any electromagnetic phenomena. Like Newton’s equations of motion, Maxwell’s equations also implicitly assume a state of rest, which gives an observer oriented or local character to the theories behind. In fact, in his theory of relativity, one argument Einstein used in justifying the principle of relativity was that, regarding the frame of reference, electromagnetic and optical phenomena can be expected to behave in the same way as phenomena in mechanics. According to analyses of Lorentz and Poincaré, local observations of electromagnetic phenomena could not be explained in linear Newtonian space. The biggest question was raised by the velocity of light which was not increased by the velocity of the observer, but appeared constant to all observers in linear motion.

Henri Poincaré gave a careful study of the principle of relativity in his treatise *La mesure du temps* (*The Measure of Time*)<sup>55</sup> published in 1898. Altogether, the works of Lorentz and Poincaré on the theoretical description of electromagnetic phenomena gave a wide-ranging basis to the synthesis presented by Albert Einstein in his special theory of relativity in 1905. In his paper *Zur Elektrodynamik bewegter Körper*<sup>56</sup> (*On the Electrodynamics of Moving Bodies*), Einstein derives Lorentz’s transformation equations in purely kinematic terms by postulating the principle of relativity, the relativity of simultaneity, and the constancy of the velocity of light – thus eliminating the need for physical explanations of the length contraction or the existence or properties of a possible aether.

*The special theory of relativity*

The key choices by Einstein in the formulation of the special theory of relativity were the principle of relativity and a new conception and definition of time. He assumed that the observations of electromagnetic phenomena and light, like the laws of mechanics, are subject to laws of nature that are independent of the motion of the observer. Based on the relativity principle, he rejected the absolute state of rest and the aether thus allowing any observer to consider his state as the state of rest regarding electromagnetic phenomena and the propagation of light. The kinematic approach meant that the “actuality” in a reference frame in motion relative to an observer is seen different than by a local observer in the moving frame.

In his 1905 paper *Zur Elektrodynamik bewegter Körper*<sup>1</sup> Einstein begins the derivation of his theory by defining time and by postulating the constancy of the velocity of light. According to the relativity principle, the relativistic world is symmetric; mutual observations from each of two reference frames in relative linear motion shall be

---

<sup>55</sup> H. Poincaré, “*La mesure du temps*”, *Revue de métaphysique et de morale* 6: 1–13, [wikisource.org](https://en.wikisource.org/wiki/Henri_Poincar%C3%A9:_La_mesure_du_temps)

<sup>56</sup> A. Einstein, *Zur Elektrodynamik bewegter Körper*, *Annalen der Physik* 322 (10): 891–921, [wikisource.org](https://en.wikisource.org/wiki/Special_Theory_of_Relativity)

equal, which means, for example, that each observer sees the time in the other observer's frame dilated as compared to the time in his own frame.

Einstein's reasoning was based on the synchronization of the two-way propagation time of light in the observer's frame at rest and in a frame moving relative to the observer. In the observer's frame at rest the two-way time light propagates a distance  $AB=R$  at a velocity  $c$  from point  $A$  to  $B$  and back, is

$$T_{AB} + T_{BA} = 2 \cdot \frac{R}{c} = 2T \quad (1.10)$$

In order to match the propagation time the observer sees in a frame moving at velocity  $v$  in the direction of  $AB$  relative to the observer, Einstein expresses the observed two-way propagation in the moving frame as

$$a \cdot T = \frac{1}{2} (t_{AB} + t_{BA}) = \frac{1}{2} \left( \frac{b \cdot R}{c-v} + \frac{b \cdot R}{c+v} \right) = \frac{c \cdot bR}{c^2 - v^2} = \frac{bR}{c} \frac{1}{1 - (v/c)^2} \quad (1.11)$$

where the factor  $a$  modifies the one-way propagation time  $T$  in the rest frame, or the half of the two-way propagation time in the moving frame, and the factor  $b$  modifies the distance  $R$  in such a way that the average two-way velocity of light obtains the same value  $c$  as it is in the rest frame

$$c = \frac{R_{(lepotila)}}{T_{(lepotila)}} = \frac{bR_{(liiketila)}}{aT_{(liiketila)}} \frac{1}{1 - (v/c)^2} = \frac{R'_{(liiketila)}}{T'_{(liiketila)}} \quad (1.12)$$

Based on equation (1.11), equation (1.12) applies when  $b/a = 1 - (v/c)^2$ .

As obvious from equation (1.10), time  $2T$  means the two-way propagation time between points  $A$  and  $B$  at distance  $R$  from each other. In the rest frame  $T$  is equal in both directions. In the moving frame, time  $T'$  is the average of the two-way propagation time – however, the propagation times in opposite directions are not the same, which is seen by substituting distance  $R'$  in (1.15) for  $bR$  in the expression of the two one-way propagation times in equation (1.11)

$$t_{AB} = \frac{b \cdot R}{c+v} = R \frac{\sqrt{1 - (v/c)^2}}{c+v}, \quad t_{BA} = R \frac{\sqrt{1 - (v/c)^2}}{c-v}$$

This means, that the relativity principle, which requires that all observations are independent of the relative velocity, applies for the two-way propagation time required by Einstein, but not for the opposite one-way propagation times!

Einstein generalized the time dilation obtained from the adjustment of the two-way velocity of light. Modern atomic clocks are accurate enough for easy comparison of ticking frequencies of clocks in relative motion to each other. The frequencies are not dependent on the relative velocity of the clocks but the states of motion and gravitational state of the clocks in the energy frames common to the clocks in question (see Chapter 4, *Models and observations*).

If the correction is made to time only,  $b = 1$  and  $a = 1/[1-(v/c)^2]$ , and

$$T' = aT = \frac{T}{1-(v/c)^2} \quad (1.13)$$

which means that we end up to Voigt's transformation, where  $R' = R$  and also the length of  $R$  perpendicular to the velocity  $v$  is  $R'_\perp = R$ . Einstein assumes, that the distance perpendicular to velocity  $v$  is conserved, but the distance in the direction of motion is contracted, which means that he ends up with the Lorentz transformation, in which the necessary correction  $b/a = 1-(v/c)^2$  is divided equally between a length contraction in the direction of velocity  $v$  and a time dilation. Then the time dilation is

$$T' = aT = \frac{T}{\sqrt{1-(v/c)^2}} \quad (1.14)$$

and the length contraction in the direction of velocity  $v$

$$R' = bR = R\sqrt{1-(v/c)^2} \quad (1.15)$$

Einstein derived a formula for the composition of velocities in such a way that the summed velocity will not exceed the velocity of light,  $c$  [§5 in *Zur Elektrodynamik bewegter Körper*]. In the case of parallel velocities, the composition of velocities obtains the form

$$V = \frac{v + w}{1 + vw/c^2} \quad (1.16)$$

Later on, Einstein stated that he got important support for his transformation formulas from the formula for the addition of velocities, which produces the same prediction for the effect of a moving propagation medium as the Fresnel 1819 formula, experimentally confirmed by Fizeau in 1851. The similarity of the two expressions was observed by the German physicist, and an important supporter for Einstein, Max von Laue<sup>57</sup>.

As shown by Lorentz and Poincaré, the Lorentz transformation conserves distance differential  $ds$  defined by equation

$$(dx)^2 + (dy)^2 + (dz)^2 - (i c dt)^2 = (ds)^2 \quad (1.17)$$

as well as Maxwell's equations in a moving frame of reference. Einstein reconfirms the conservation of Maxwell's equations, analyses the aberration of light, and derives an expression for the Doppler effect, and the radiation pressure observed in a moving frame.

A result of special importance in the 1905 paper was the expression for the kinetic energy, applying dilated time and contracted distance to Newton's second law for

<sup>57</sup> M. Laue, *Annalen der Physik* 23: 989–990 (1907), [wikisource.org](http://www.wikisource.org)

acceleration or the longitudinal mass derived by Lorentz. Integration of force from  $x=0$  to  $x$ , and the velocity from zero to  $v$ , resulted in

$$E_{kin} = \int_0^x \frac{m dv/dt}{[1-(v/c)^2]^{3/2}} dx = \int_0^v \frac{mv dv}{[1-(v/c)^2]^{3/2}} = \frac{mc^2}{\sqrt{1-(v/c)^2}} - mc^2 = E_{tot} - E_{rest} \quad (1.18)$$

The result suggested the presence of rest energy  $E = mc^2$ , the energy of a mass object at rest. According to (1.18) the total energy increases without limits when velocity  $v$  approaches the velocity of light.

In fact, the idea of the energy of mass was not new; the possibility of the electromagnetic mass had been concluded by the English physicists Joseph John Thomson<sup>58</sup> in 1881, and Oliver Heaviside<sup>59</sup> in 1889. In his treatise *La théorie de Lorentz et le principe de réaction*<sup>60</sup> (*The Theory of Lorentz and The Principle of Reaction*), published in 1900, Henri Poincaré, with reference to Poynting's work, compared electromagnetic radiation to a fictional fluid with mass density  $m = E/c^2$  and momentum  $mc = E/c$ .

Einstein's 1905 paper *Zur Elektrodynamik bewegter Körper* was received with confusion. Lorentz and Poincaré had been searching for physical explanations of length contraction and time dilation from the electromagnetic properties of aether and the modifications of electrons moving in the aether. Einstein declared the principle of relativity as a law of nature and the velocity of light as a universal invariant, which eliminated the need for the existence of both the aether and an absolute frame of reference. Mathematically, the solution was consistent with Maxwell's equations – in spite of the fact that the derivation of Maxwell's equations was based on the existence of the aether.

The picture of reality reflected by the special theory of relativity was cleared by the spacetime interpretation introduced by the Lithuanian Jewish mathematician Hermann Minkowski<sup>61</sup> in 1907. In Minkowski's spacetime the quantity  $ct$  was linked to three space directions as an orthogonal imaginary dimension. In fact, Minkowski's spacetime was expressed with equation (1.17) already understood as a consequence of the Lorentz transformation by both Lorentz and Poincaré. Minkowski introduced the concept of *proper time*, which was identical to *local time* used by Lorentz.

Figure 1-24 illustrates the development paths behind the special theory of relativity.

<sup>58</sup> J.J Thomson, *Philosophical Magazine*, 5 **11** (68): 229-249 (1881), [wikisource.org](https://en.wikisource.org/wiki/J.J._Thomson:_Philosophical_Magazine_1881)

<sup>59</sup> O. Heaviside, *Philosophical Magazine*, 5 **27** (167): 324-339 (1889), [wikisource.org](https://en.wikisource.org/wiki/Oliver_Heaviside:_Philosophical_Magazine_1889)

<sup>60</sup> H. Poincaré, <http://www.physicsinsights.org/poincare-1900.pdf>

<sup>61</sup> H. Minkowski, [wikisource.org](https://en.wikisource.org/wiki/Hermann_Minkowski:_The_Fundamentals_of_Physics)

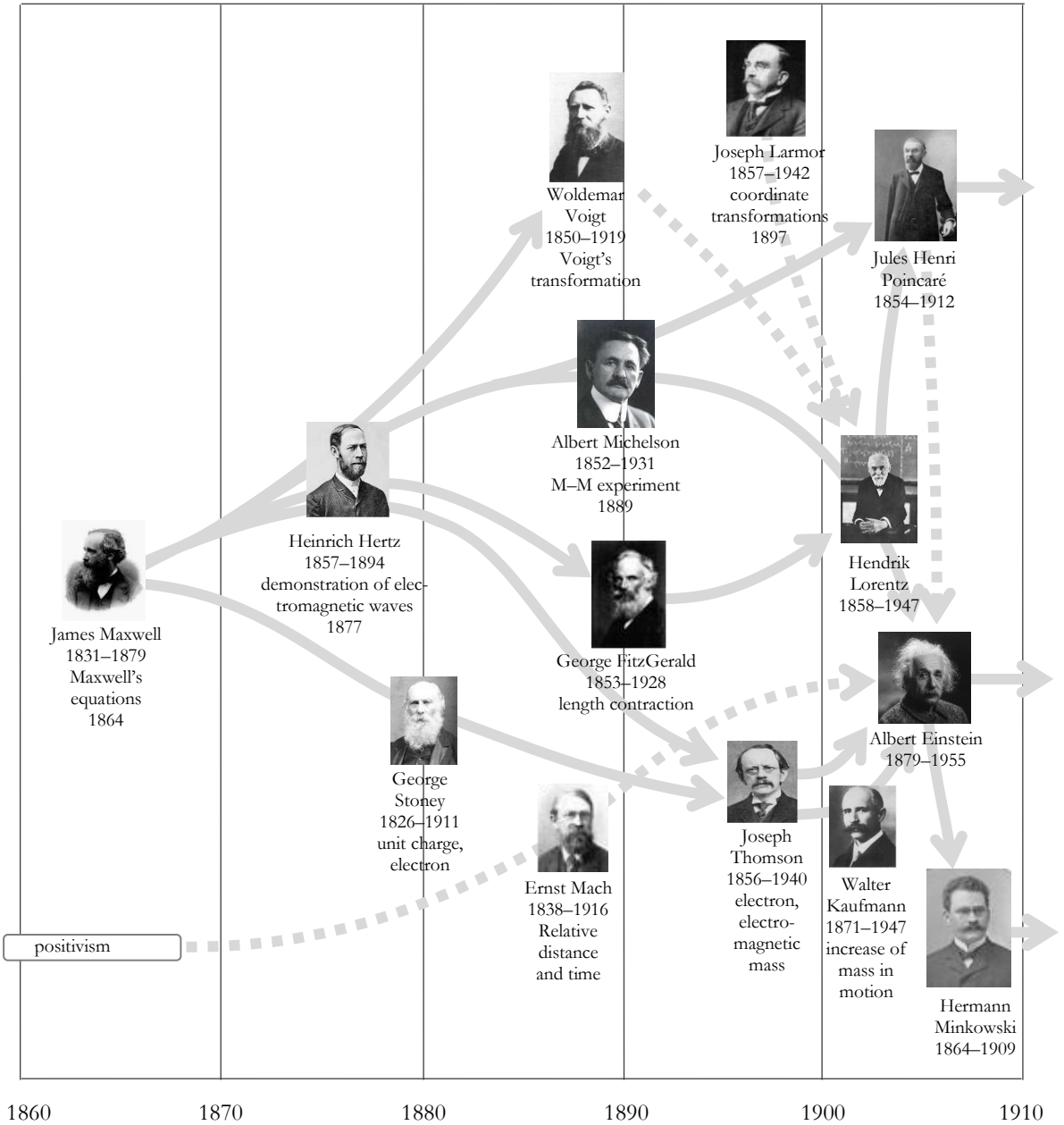

Figure 1-24. Works behind and parallel with the special theory of relativity. The central basis in the theory of relativity is in the coordinate transformations developed for explaining the emission, propagation and receiving of electromagnetic radiation in reference frames moving relative to each other – and the works on electromagnetic mass and the increased mass of moving electrons. The logical positivism presented by Ernst Mach gave philosophical acceptance to the valuation of mathematical description of observations as laws of nature.

## From radiation quantum to quantum mechanics

### *Planck's equation*

Planck's equation was an unexpected byproduct of Max Planck's solution for the spectrum of black body radiation. It was based on Max Planck's idea that the radiation balance in a black body cavity is controlled by monochromatic resonators that exchange energy in proportion to the frequency. Accordingly, an energy exchange unit appears as an *energy quantum*

$$E = h \cdot f \quad (1.19)$$

where the proportionality factor  $h$  is the Planck constant. Planck understood the equation as an *ad hoc* finding in disagreement with Maxwell's equations. In 1906, in his lectures in Columbia University Hendrik Lorentz stated the superiority of Max Planck's theory of the black body radiation. Regarding the basis of the theory, he stated: "Yet, we cannot say that the mechanism of the phenomena has been unveiled by it, and it must be admitted that it is difficult to see a reason for this partition of energy by finite portions, which are not even equal to each other, but vary from one resonator to another".<sup>62</sup>

As a footnote in his book, published in 1916 in his Columbia lectures, *The theory of electrons and its applications to the phenomena of light and radiant heat* Lorentz states:

"Since this was written, Planck's theory of "quanta" has been largely developed. It now (1915) occupies a prominent place in several parts of theoretical physics".<sup>64</sup>

The study that Max Planck performed regarding Maxwell's equations did not include an "antenna analysis", in which the energy emitted by a dipole in an oscillation cycle is expressed as a function of the number  $N$  of the oscillating electrons, the geometrical factor  $A$  of the dipole, and the length of the dipole relative to the wavelength  $\lambda$  emitted. When such an analysis is carried out<sup>63</sup>, we can find that the energy emitted by any dipole into one cycle of radiation has the form

$$E = N^2 \cdot A \cdot \left(\frac{\tilde{x}}{\lambda}\right)^2 \cdot 2\pi^3 \epsilon^2 \mu_0 c \cdot f \quad ; \quad E_0 = h \cdot f \quad (1.20)$$

Equation (1.20) obtains the exact form of Planck's  $E_0 = h \cdot f$ , and the precise value of the Planck constant  $h$  when a single electron ( $N=1$ ) makes one oscillation cycle in one-wavelength dipole with geometrical factor  $A = 1.1049$ .

A further message of equation (1.20) is that the Planck constant  $h$  has the velocity of light as a hidden factor. When the velocity of light is removed the "energy quantum" obtains the form

$$E_0 = h_0 c \cdot f = \frac{h_0}{\lambda} c^2 = m_\lambda c^2 \quad (1.21)$$

where  $h_0$  can be referred to as the intrinsic Planck constant. The quantity  $h_0/\lambda = m_\lambda$  has the dimension of mass [kg]. Mass  $m_\lambda$  can be referred to as the mass equivalent of a cycle of radiation per one oscillating electron in the emitter. (see Chapter 3, *The connection between Planck's equation and Maxwell's equations*).

<sup>62</sup> H. Lorentz, *Theory of electrons, A course in Columbia University, N.Y. (1906) p.80*

<sup>63</sup> T. Suntola, Photon - the minimum dose of electromagnetic radiation, *Proceedings of SPIE Vol. 5866 (2005), p. 18*



*Photoelectric effect*

In 1887, Heinrich Hertz had observed that ultraviolet light enhanced the generation of sparks between the electrodes in his apparatus for the demonstration of electromagnetic waves. In 1888, J.J. Thomson studied the effect of ultraviolet light in *Crookes tubes*, an early form of cathode ray tubes. In his work that led to the identification of the electron, Thomson observed that the electric current was strengthened when the cathode was illuminated with ultraviolet light.

In 1887 Heinrich Hertz had observed that ultraviolet light increased the buildup of sparks between the electrodes in his spark receiver. In 1889, J.J. Thomson studied the effect of ultraviolet light in *Crooke's tube preceding the cathode ray tube*. In the studies leading to the recognition of electron, Thomson observed, in parallel to Hertz's experiments, that the electric current was strengthened when by ultraviolet light directed to the cathode emitting electrons. When working with cathode ray tubes in the first years of the 20<sup>th</sup> century, the German physicist Philipp Lenard observed that the stopping potential of electrons emitted from the cathode was dependent on the wavelength of the ultraviolet light used for the activation of the emission at the cathode. It turned out that the intensity of the light increased the quantity of electrons emitted, but the kinetic energy of the electrons was determined by the wavelength of the light. The result was unexpected; its connection to Maxwell's equations was not recognized.

Albert Einstein considered Planck's equation as a law of nature and an indication of the corpuscular nature of light. In his paper *On a Heuristic Viewpoint Concerning the Production and Transformation of Light*<sup>64</sup>, published in 1905, Einstein defends the wave theory of light for the explanation of optical phenomena, but sees the "continuous spatial functions" (waves) as contradictory phenomena related to the "generation and transformation of light". In the paper he states:

*"...In particular, black body radiation, photoluminescence, generation of cathode rays from ultraviolet light and other phenomena associated with the generation and transformation of light seem better modeled by assuming that the energy of light is distributed discontinuously in space. According to this picture, the energy of a light wave emitted from a point source is not spread continuously over ever larger volumes but consists of a finite number of energy quanta that are spatially localized at points of space, move without dividing and are absorbed or generated only as a whole".*

Einstein proposed that energy quanta penetrate into the cathode, and at least part of their energy is transferred to the kinetic energy of electrons emitted. If we assume that the whole energy of a quantum is transferred to the electron, part of it will be lost in collisions before the electron reaches the surface of the cathode. Further, we need to suppose, that part of the energy is lost to the work function, the work needed for removing of the electron from the cathode. The remaining part of the kinetic energy can be measured from the electrons emitted. The prediction given by Einstein for the observable kinetic energy was in line with Lenard's observations. In repeated measurements, Einstein's prediction could be confirmed with high accuracy – in addition it allowed the determination of the numerical value of the Planck constant and the work function of the cathode material used.

---

<sup>64</sup> A. Einstein, Ann. Phys. 17, 132 (1905) <https://en.wikisource.org/?curid=59468>

In spite of the fact that Einstein's equation for the photoelectric effect received a general acceptance, there was a lot of suspicion on his postulate of light quanta, because the wave theory of light was seen as unambiguously proven. The concept of light quanta was understood as being supported by the experiments with X-ray scattering carried out by the American physicist Arthur Compton in 1922. In these experiments X-rays were observed releasing energy to free electrons in proportion to the scattering angle. A detailed description of the photon had to wait for the development of the atomic model and the theoretical bases of quantum mechanics, which merged the concepts of the particle nature of an electromagnetic wave and the wave nature of particles.

### *Atomic model*

The concept that matter is composed of undividable units has been inherited from antique philosophes. Galileo Galilei absorbed the atomic doctrine of Democritus and Epicurus, and supposed that atoms as well as macroscopic bodies made of atoms follow the same laws of mechanics. The first quantitative indications of atoms and molecules were obtained from the studies of stoichiometry by the French chemist Antoine Lavoisier in the late 18<sup>th</sup> century <sup>65,66</sup>. Based on his experiments, Lavoisier formulated the law of conservation of mass and a theory of the formation of chemical compounds from elements, including the law of multiple proportions.

In 1800, the English chemist and physicist John Dalton presented his atomic theory based on five postulates:

- 1) *Elements are made of extremely small particles called atoms.*
- 2) *Atoms of a given element are identical in size, mass, and other properties; atoms of different elements differ in size, mass, and other properties.*
- 3) *Atoms cannot be subdivided, created, or destroyed.*
- 4) *Atoms of different elements combine in simple whole-number ratios to form chemical compounds.*
- 5) *In chemical reactions, atoms are combined, separated, or rearranged.*

In his study on the proportions of the elements Dalton was able to conclude the presence of multi-atomic molecules that were found by the Italian physicist and mathematician Amedeo Avogadro in 1811. Avogadro is best known of the *Avogadro constant* that defines the number of molecules in a mole.

The first estimate of the numerical value of the Avogadro constant was given by the Austrian physicist and chemist Josef Loschmidt in 1865. The precise value of the Avogadro constant was obtained first after the determination of the unit charge by the American physicist Robert Millikan in 1910. Before that, Michael Faraday had determined the electric charge required for the removal of one mole of material in electrolysis. Dividing the charge needed for the removal of a mole by the charge of an electron resulted in the Avogadro constant. The fact that the charge related to a

---

<sup>65</sup> [Traité élémentaire de chimie \(Elementary Treatise on Chemistry\)](#) (1789)

<sup>66</sup> M. Lavoisier, *Essays, Physical and Chemical*, [English translation by Thomas Henry \(1776\)](#)

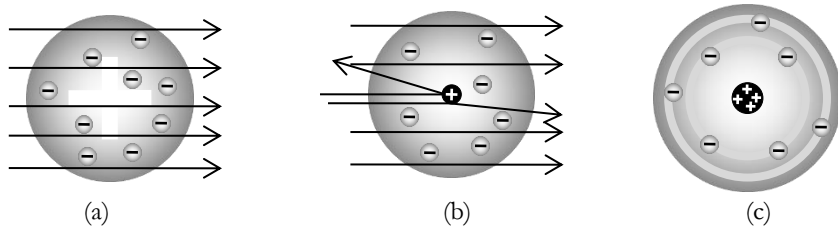

Figure 1-25. (a, b) Results from the Geiger-Marsden experiment indicated that the mass of an atom is concentrated in a small nucleus. A thin gold foil was bombarded with  $\alpha$ -particles (Helium nuclei). For explaining the backscattering, Rutherford assumed that the bombarding particles hit the positively charged nuclei in the gold foil. Observations were explained by assuming that the mass and the positive charge of the gold atoms are concentrated in the nuclei. c) Rutherford's atomic model<sup>1</sup>, where light electrons orbit the heavy nucleus like planets in the solar system. Rutherford did not determine the orbits of the electrons, although he refers to Nagaoga's theory<sup>1</sup> with electron orbits compared to Saturn rings.

mole tells about the elementary charge bound in an atom, was realized by the Irish physicist George Stoney in 1870s.

Thanks to Dalton's atomic theory, atomism was well stabilized among chemists. In the 1870s, the majority of physicists, however, envisaged matter as continuous although Ludvig Boltzmann already worked on the statistic thermodynamics based on atoms. The increased understanding of electromagnetism in the late 19<sup>th</sup> century opened new possibilities in the study of atoms and their internal structure. Maxwell's concept of aether created ideas of describing atoms in terms of the aether; Joseph Larmor described the electron as a singularity of the aether, and the atom as a condensation of electrons.

Based on his experiment in the 1890s, J.J. Thomson concluded that the electron is a building element of the atom, and that the size of an electron is just a fraction of the size of an atom or a molecule. Thomson estimated that the mass of an electron is about 1/1800 of the mass of the hydrogen atom. He thought that electrons are distributed in the positively charged atomic matter. The positively charged part of an atom, the proton, was found by Wilhelm Wien in his studies on ionized gas in 1898. First in 1911, the "gold foil" experiment by the New Zealand chemist and physicist Ernest Rutherford and his coworkers showed that the mass of an atom is concentrated into a small positively charged nucleus. Based on his observations, Rutherford developed an atomic model, where the positively charged nucleus is orbited by a cloud of electrons, possibly like the rings of Saturn, Figure 1-25.

#### *Bohr's atomic model*

In 1913, the Danish physicist Niels Bohr combined Rutherford's planetary concept, the Planck equation, and the classical laws of mechanics into a "semi-classical" atomic model. He assumed that the allowed angular momenta of electrons in classical planetary orbits are multiples of the Planck constant. Such an approach produced

discrete electron orbits with discrete energies. Electron transitions from one state to another were characterized by energy differences that determined the characteristic emission and absorption wavelengths of the atom. As an immediate confirmation of the model, the characteristic wavelengths corresponded to the experimental *Rydberg formula* for the energy spectrum of hydrogen introduced by the Swedish physicist Johannes Rydberg in 1888, Figure 1-26(a).

In addition to the success in explaining the emission and absorption spectra, the atomic model was supported by unit charge determined by Robert Millikan in 1911. The German physicist Arnold Sommerfeld generalized the Bohr model by adding elliptic orbits for the electrons, Figure 1-26(b). Elliptic orbits produced energies that were later identified as the fine structure states obtained by spherical harmonics in a quantum mechanical solution. Mathematically the result is interesting, because the harmonic waves in an elliptic orbit can be expressed as the superposition of harmonic waves in the directions of the circular orbit and its radius – corresponding to the structure of spherical harmonics.

Bohr's idea in the atomic model was primarily based on the application of Planck's constant and its multiples to the angular momentum of the electron. The solution allowed the expression of the orbital momentum of an electron both as the classical momentum and as the momentum of a wave characterized by a wave number which is a multiple of the length of the orbit. Accordingly, the quantization of the angular momentum could be equally interpreted as a resonance condition of an "electron wave" in the allowed orbits.

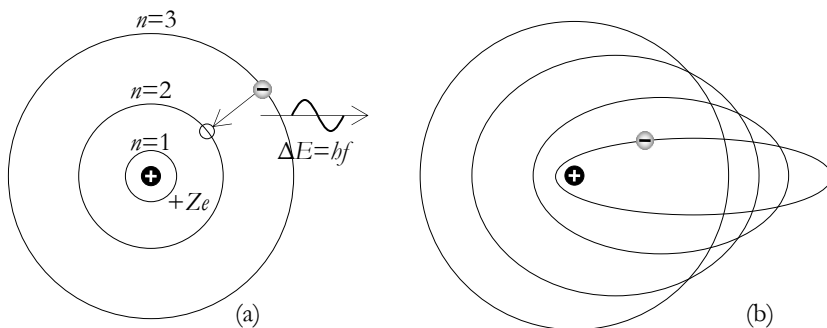

Figure 1-26. (a) The Bohr model meant a breakthrough in atomic physics<sup>67</sup>. Application of a quantum condition to the classical electron orbit resulted in orbit energies that explained the experimental *Rydberg formula* for the energy spectrum of hydrogen. (b) Sommerfeld completed the Bohr model by adding elliptic electron orbits like the planetary orbits in celestial mechanics<sup>68</sup>. Sommerfeld's model gave correct values for the fine structure states – however, the quantum mechanical solutions based on spherical harmonics replaced Sommerfeld's model and the semi-classical approach to quantum mechanics.

<sup>67</sup> Niels Bohr, *On the quantum theory of line-spectra* (1918), [openlibrary.org](https://openlibrary.org)

<sup>68</sup> Arnold Sommerfeld, *Atombau und Spektrallinien* (1921), [openlibrary.org](https://openlibrary.org)

*de Broglie and Compton wavelengths*

The resonance interpretation of Bohr's model turned up as an important step towards quantum mechanics. In his doctoral thesis in 1924, the French physicist Louis de Broglie presented a generalized expression for the wave description of a mass object. The description was based on the momentum of the object, which was interpreted as the momentum of a wave obtained from Planck's equation

$$\mathbf{p}_\lambda = \frac{h}{\lambda_{dB}} \hat{\mathbf{r}} = \frac{mv}{\sqrt{1-(v/c)^2}} \hat{\mathbf{r}} \quad ; \quad \lambda_{dB} = \frac{h}{p} \quad (1.22)$$

According to the wave interpretation, the momentum of a mass wave is the Planck constant divided by the *de Broglie wavelength*, which means that the mass wave is assumed to propagate at the velocity of light just like electromagnetic radiation. de Broglie assumed that a mass particle is a localized object that maintains its internal oscillation in a similar way as electrons in their closed orbits in atoms. He did not agree with the generalization according to which the mass wave, or momentum wave, propagated freely at the velocity of light, independent of the velocity of the particle – as interpreted in generalized wave mechanics. de Broglie's interpretation was further developed by the American physicist David Bohm.

In 1923, one year before de Broglie's wave hypothesis, Arthur Compton had observed that the wavelength of the X-rays scattered from free electrons increases with the scattering angle. Compton explained the phenomenon with the momentum released by the radiation to the electrons – he justified the inelastic nature of the collisions with the corpuscular radiation quantum postulated by Albert Einstein in 1905 in his explanation of the photoelectric effect. Compton assumed that radiation is composed of photon particles; the mass of the particles was obtained by combining the expression of the rest energy and Planck's equation

$$m = \frac{E}{c^2} = \frac{hf}{c^2} = \frac{h/c}{\lambda_C} \quad (1.23)$$

The expression of the rest mass of an object as a mass wave produced the concept of the Compton wavelength

$$\lambda_C = \frac{h/c}{m} \quad (1.24)$$

The interpretation of Compton scattering was seen as evidence for Einstein's interpretation of photons as localized particle-like objects. In the interpretation of the Compton effect the discrete momentum transferred was considered as an inherent property of the photon, not a property of the collision phenomenon or the receiving electron.

The "antenna interpretation" of Planck's equation  $E_0 = h_0 c \cdot f = \frac{h_0}{\lambda} c^2 = m_\lambda c^2$  shows immediately the Comptonian connection between the mass and the wavelength. This means that the quantization shall be considered as a property of the "antenna", i.e. the emitter and the absorber. The Compton scattering as well as the photoelectric effect can be explained without localized photons by applying the concept of active area in antenna theory.

### *Wave function*

Planck's equation, the concept of photon, as the key to Einstein's explanation of the photoelectric effect, the wave equivalents of the momentum and the rest energy of matter by de Broglie and Compton, and the interpretation of Bohr's atomic model in terms of standing waves paved the way to a general theory of wave description of particles and material structures. Such a theory assumed a hypothesis of wave – particle dualism: for explaining observations on particles, both corpuscular character and wave character of particles were needed – other way round, the explanation of Compton scattering and the Einsteinian photoelectric effect assumed corpuscular character of electromagnetic waves.

The wave description of a mass particle relies on the uncertainty principle introduced by the German theoretical physicist Werner Heisenberg in 1927. The uncertainty principle eliminates the point-like character of a classical particle by identifying certain combined properties that can be observed with a limited accuracy. Such pairs of properties are the location and the momentum of the particle, and the energy and time differential. Implicitly, the Heisenberg uncertainty principle defines the Planck constant as *a quantum of action*, described as the product of the differentials of momentum and location or the differentials of energy and time.

In quantum mechanics, the state function is non-local by its character. It may appear anywhere in space, at any time. Localization is obtained when the wave function disappears or approaches zero everywhere except at a specific time at a specific location – where it appears as a wave packet. The probability of finding a particle at instant  $t$  at location  $x, y, z$  is expressed in terms of the square of the wave function  $\psi(x, y, z, t)$ .

The most commonly used form of the state function is obtained from *Schrödinger's equation*, formulated by the Austrian physicist Erwin Schrödinger in 1925. Schrödinger's equation defines the state function of a physical system as a wave equation, which implicitly assumes Newton's equation of motion and, in a stationary system, boundary conditions for the resonance condition of the wave describing the state function. Quantum mechanics based on the Schrödinger equation became a great success, for example, in the description of the properties of atoms, molecules and solid state structures. Figure 1-27 outlines the development towards quantum mechanics.

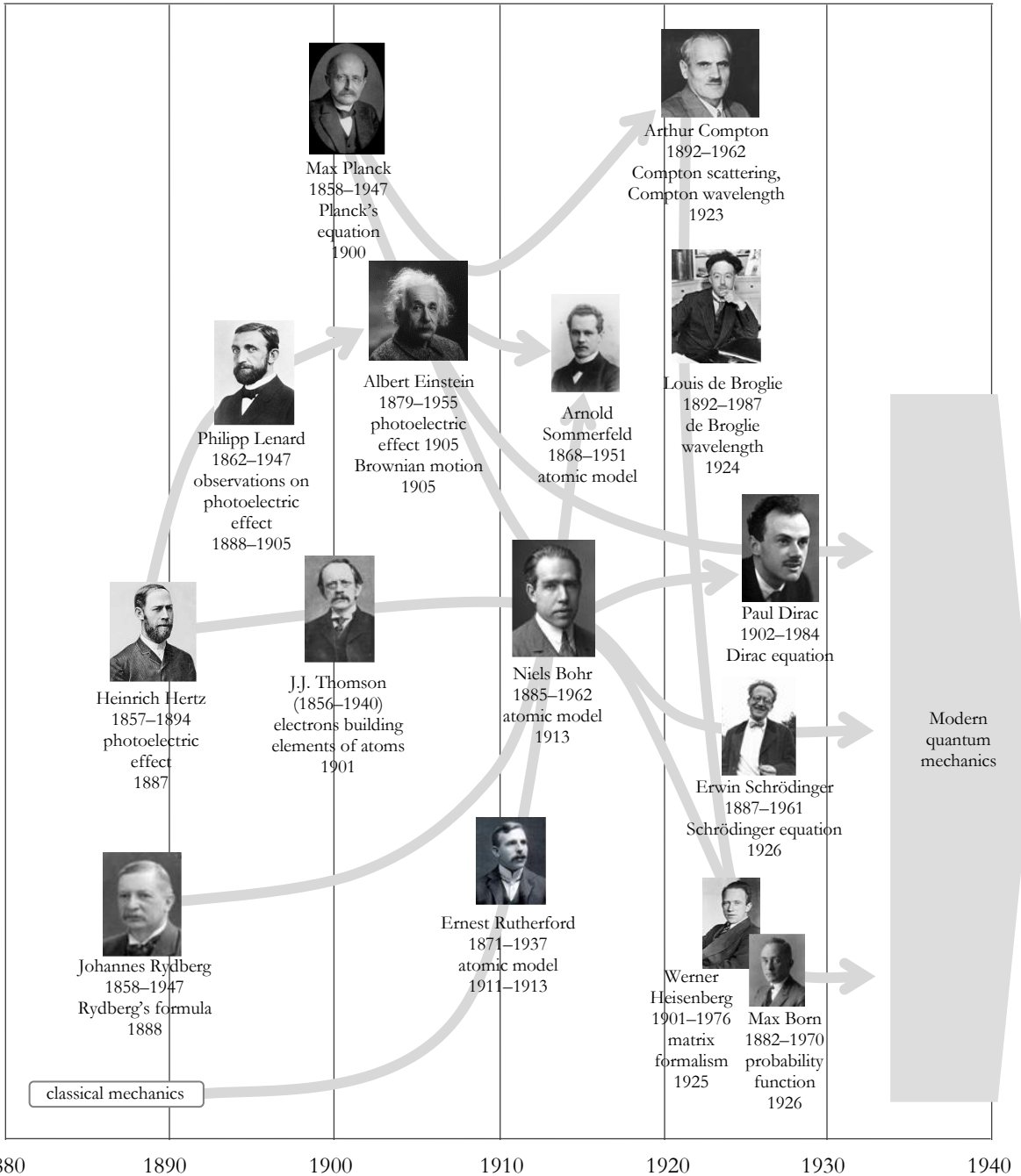

Figure 1-27. From Planck's equation, the photoelectric effect, and the atomic model to quantum mechanics. In his explanation of the photoelectric effect, Albert Einstein introduced a corpuscular interpretation of Planck's equation, and applied it to the experimental results obtained by Philipp Lenard. Compton scattering was interpreted as evidence supporting Einstein's quantum hypothesis that together with Bohr's atomic model triggered the development towards modern quantum mechanics.

Once bound to Newtonian mechanics, the Schrödinger equation does not apply to the theory of relativity. Wave equations consistent with special relativity have been derived by the Swedish physicist Oskar Klein and the German physicist Walter Gordon in 1927, and the English physicist Paul Dirac in 1928. Both in Klein-Gordon's and Dirac's equations the derivatives relative to time and distance are mutually symmetric like in wave equations for electromagnetic radiation obtained from Maxwell's equations. The equations are consistent with the relativistic momentum and the total energy as the sum of the rest energy and kinetic energy.

Quantum electrodynamics is a theory developed for the description of interactions between charged particles. It is characterized as a relativistic quantum field theory of electrodynamics. In quantum electrodynamics electromagnetic radiation is described in terms of corpuscular photons serving as force carriers in interactions between charged particles. Interactions are described with *Feynman diagrams*. Gauge theories derived from the principles of quantum electrodynamics have produced the Standard Model of particle physics; the Standard Model describes widely the interactions between elementary particles.



## From special relativity to general relativity and cosmology

Einstein based the generalization of the relativity theory on the equivalence principle which, in classical mechanics, equalized the gravitational acceleration and inertial acceleration – or the gravitational force and the inertial force.

For coupling gravitation and motion it was necessary to expand the special theory of relativity to objects in accelerating motion. An overall conception of general relativity formed in Einstein's thinking shortly after the introduction of the special theory of relativity when he pondered the equivalence of inertial acceleration and gravitational acceleration. Instead of turning spacetime coordinate axes by the velocity like in special relativity he introduced the concept of curved spacetime that produced gravitational acceleration and the velocity of free fall. The mathematical formulation of the theory, however, took about ten years and the general theory of relativity was published in 1916.

The general theory of relativity does not answer the question of the origin of gravitation. Newton's theory that describes gravitation as action of mass at distance, did not give an answer either. In the general theory of relativity, the effect of gravitation is described in terms of the geometry of spacetime. The geometry of spacetime is determined by the distribution of mass in space, thus linking the Einsteinian gravitation to the Newtonian gravitation.

Due to its nature as a local theory, the general theory of relativity does not answer the question of the total gravitational energy in space or the conservation of the total energy. In the framework of general relativity, the conservation of local momentum and energy is described as conservation of the pseudotensor of force-energy-momentum – which means conservation of the momentum and energy, taking into account the change in the momentum and energy resulting from the force field where the object moves. In the vicinity of an individual mass center, the geometry of spacetime appears as a dent diluting time and increasing distances in comparison to time and distances far from the mass center.

The general theory of relativity, and especially Einstein as a person, got a lot of publicity and public appreciation, when the bending of starlight due to the gravitation of the Sun, as predicted by Einstein's theory, was observed during the solar eclipse in 1919.

Another remarkable achievement was the solution to the missing 43 arc-seconds/century shift in the perihelion of planet Mercury's orbit. In 1859, based on Newton's gravitation and Kepler's laws, the French astronomer Urbain Le Verrier had shown that the major axis of Mercury's orbit rotates due to the gravitational effects of other planets 5557 arc seconds in a century. The observed rotation, however, was 5600 arc seconds in a century, which meant that the missing 43 arc seconds could not be explained by Newtonian mechanics. The prediction of general relativity for the missing shift was quite precisely 43 arc seconds, which meant that the observed shift became explained.

Einstein's general theory of relativity was published in *Annalen der Physik*, Vol 354(7), 1916, entitled *Die Grundlage der allgemeinen Relativitätstheorie*<sup>69</sup>. In his paper *Kosmologische Betrachtungen zur allgemeinen Relativitätstheorie*<sup>70</sup>, published in 1917, he outlines the cosmological appearance of general relativity, and introduces spherically closed space with the radius as the fourth dimension. Einstein was looking for a static solution – for preventing the collapse of the 4-sphere due to its gravitation he added a cosmological constant to the field equations.

Immediately after the publication of the general theory of relativity, the Dutch astronomer and mathematician Willem de Sitter analyzed the theory and its consequences in his wide-ranging treatise *On Einstein's Theory of Gravitation, and its Astronomical Consequences*<sup>71,72</sup>. He derived, for example, estimates for the perihelion shift and the tilting of light in the vicinity of a mass center. Also, he analyzed Einstein's spherically closed space and added the possibility of elliptically closed space as his own proposal<sup>73</sup>. de Sitter's estimate for the radius of the closed space was 1.5 – 800 million light years, where the upper limit of his estimate is about 1/200 of the present estimate of the Hubble radius. In addition to visible mass, de Sitter's space was occupied by unobservable "world matter" for securing the homogeneity of mass at cosmological distances. Also, he developed a model for "empty space", which needed the cosmological constant but not the "world matter". In de Sitter's space mass objects receded from each other. He justified the recession with the systematic redshift, corresponding to about 4.5 km/s recession velocity, observed in helium stars. He also refers to the systematic redshift observed by the American astronomer William Campbell in K-stars.

Before Einstein's 1916 paper in *Annalen der Physik* the German physicist Karl Schwarzschild had found an exact solution to the field equations in the vicinity of a single mass center. Schwarzschild had sent his solution to Einstein at the end of 1915. The solution included a prediction of a black hole that may be associated with an ultra-dense mass center. *Schwarzschild's radius* defines the critical radius of a black hole, Figure 1-28.

The first general, both stationary and non-stationary solution of the field equations of general relativity was presented by the Russian physicist and mathematician Alexander Friedmann *Über die Krümmung des Raumes*<sup>74</sup> (*On the curvature of space*). In his paper he states that a stationary solution is possible in two cases only, the cases Einstein and de Sitter have already analyzed. However, there are many alternatives for non-static solutions; "... there can be cases of this type when the world's radius of curvature ... is constantly increasing in time; cases are also possible when the radius of curvature changes periodically ..."<sup>75</sup>.

<sup>69</sup> A. Einstein, *Annalen der Physik* 354 (7), 769-822 (1916) [wikisource.org](http://www.wikisource.org)

<sup>70</sup> A. Einstein, <http://echo.mpiwg-berlin.mpg.de/ECHOdocuView?url=/permanent/echo/einstein/sitzungsberichte/S250UZ0K/index.meta&pn=2> (1917)

<sup>71</sup> W. de Sitter, *Monthly Notices of the Royal Astronomical Society*, **76**, 699–728 (1916)

<sup>72</sup> W. de Sitter, *Monthly Notices of the Royal Astronomical Society*, **77**, 155–184 (1916)

<sup>73</sup> W. de Sitter, *Monthly Notices of the Royal Astronomical Society*, **78**, 3–28 (1917)

<sup>74</sup> Alexander Friedmann, <http://publikationen.uni-frankfurt.de/frontdoor/index/index/docId/16735>, [English translation](#)

<sup>75</sup> <http://www-history.mcs.st-and.ac.uk/Biographies/Friedmann.html>

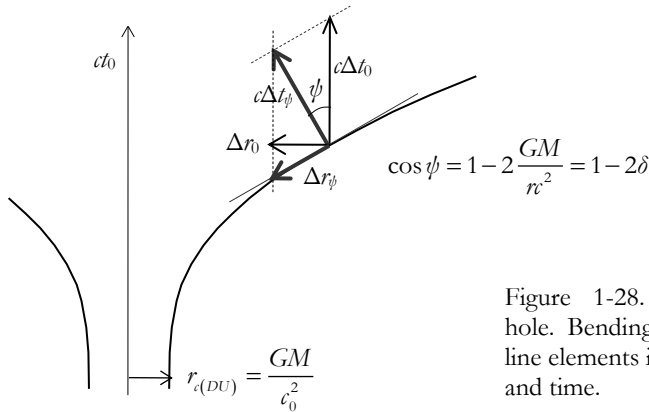

Figure 1-28. Schwarzschild's black hole. Bending of spacetime, and the line elements in the directions of space and time.

Einstein's first reaction to Friedmann's solution was repelling. He sent a response that was published in *Zeitschrift für Physik* three months after Friedmann's article. In his response, Einstein states that "...The results concerning the non-stationary world, contained in Friedmann's work, appear to me suspicious. In reality it turns out that the solution given in it does not satisfy the field equations ...".

After this, Friedmann sent his detailed solution to Einstein, and asked him to inform the editors of *Zeitschrift für Physik* in the case he states that the calculations are correct. After a remarkable delay, Einstein sent a correction to *Zeitschrift für Physik*: "...In my previous note I criticized Friedmann's work 'On the curvature of Space'. However, my criticism, as I became convinced by Friedmann's letter communicated to me by Mr Krutkov, was based on an error in my calculations. I consider that Mr Friedmann's results are correct and shed new light to the theory."

The alternative of expanding space got further support from the articles *Un Univers homogène de masse constante et de rayon croissant rendant compte de la vitesse radiale des nébuleuses extra-galactiques*<sup>76</sup> *A homogeneous Universe of constant mass and growing radius accounting for the radial velocity of extragalactic nebulae*<sup>77</sup> and *The expanding Universe*<sup>78</sup> vuodelta 1931.

In his 1931 article *The Beginning of the World from the Point of View of Quantum Theory*<sup>79</sup> published in *Nature*, Lemaitre defended his theory and discussed also the possibility of the growth of the universe from a primeval atom: "If the world has begun with a single quantum, the notions of space and time would altogether fail to have any meaning at the beginning; they would only begin to have a sensible meaning when the original quantum had been divided into a sufficient number of quanta. If this suggestion is correct, the beginning of the world happened a little before the beginning of space and time".

Einstein, like most cosmologists of the time, was more or less reluctant to accept the idea of expanding space. A difficult question was the beginning of the universe as suggested by Lemaitre's analysis. Change in the attitudes was encouraged by new evidences about the expansion of space, published in 1929 by the American astronomer Edwin Hubble in his article *A Relation between Distance and Radial Velocity among*

<sup>76</sup> Georges Lemaitre, *Annals of the Scientific Society of Brussels*, 47, 49–59 (1927)

<sup>77</sup> Georges Lemaitre, *Monthly Notices of the Royal Astronomical Society* 91, 483–490 (1931)

<sup>78</sup> Georges Lemaitre, *Monthly Notices of the Royal Astronomical Society* 91,490–501 (1931)

<sup>79</sup> Georges Lemaitre, *Nature*, Volume 127, Issue 3210, pp. 706 (1931)

*Extra-Galactic Nebulae*<sup>80</sup>. In his article *On the instability of Einstein's spherical world*<sup>81</sup> Einstein's strong supporter, the English astrophysicist Arthur Eddington described Lemaître's model with expanding space as "Lemaître's brilliant solution".

In his article *On the magnitudes, diameters and distances of the extragalactic nebulae, and their apparent radial velocities*<sup>82</sup> published in 1930, de Sitter, based mainly on Hubble's observations, estimated the ratio between recession velocities calculated from redshifts and distances obtained from the magnitudes and angular sizes of the objects. Based on the expansion velocity he obtained an estimate of 200 million light years for the radius of the curvature (the Hubble radius). At the end of the paper he states that he got Lemaître's 1927 article just a few weeks before completing the current article. In a short calculation he states that Lemaître's theory gives a radius of the same order of magnitude. Also, he concludes that Einstein's static model does not correspond to the observations he had at hand.

In his article *On the Energy and Entropy of Einstein's Closed Universe*<sup>83</sup>, in 1928, Richard Tolman studies thermodynamics in Einstein's closed universe and concludes that a growth of entropy occurs in space filled by homogeneous matter. In his article *On the Astronomical Implications of the de Sitter Line Element for the Universe*<sup>84</sup> in 1929, he studies the line element in de Sitter's empty space and concludes that it does not explain the distances, Doppler-shifts, and distributions observed from distant objects.

In his article *The expanding universe. Discussion of Lemaître's solution of the equations of the inertial field*<sup>85</sup> in 1930, de Sitter analyzes Lemaître's expanding space. In his article *Do the galaxies expand with the universe*<sup>86</sup> in 1931, de Sitter concludes that galaxies do not expand with the expansion space – a conclusion that obtained consensus in the FLRW (Friedmann–Lemaître–Robertson–Walker) cosmology developed in the 1930s.

In his article *The size of the Universe*<sup>87</sup> in 1932, de Sitter summarizes the cosmological concepts presented. He states that his own model of empty space and Einstein's models of static space with a specific mass density, present extremes between which the correct description of space can be found. He considered that the best candidate was Lemaître's model that allows both finite mass density and expansion.

Einstein, together with other cosmologists, had to swallow the idea of an expanding universe. In 1932, Einstein and de Sitter published *Einstein – de Sitter metrics* in the paper *On the Relation Between the Expansion and the Mean Density of the Universe*<sup>88</sup>. Einstein–de Sitter-metrics is based on Friedmann's solution in the case of critical mass density of space and a zero cosmological constant. The expansion of Einstein–de

<sup>80</sup> E. Hubble, [Proc. N.A.S. 15, Issue 3, 168-173\(1929\)](#)

<sup>81</sup> A.S. Eddington, [MNRAS 90, 668–678 \(1930\)](#)

<sup>82</sup> W. de Sitter, , [B.A.N. 5, No.185, 157–171 \(1930\)](#)

<sup>83</sup> R. Tolman, [Proc. N.A.S. 14, 348–353 \(1928\)](#)

<sup>84</sup> R. Tolman, [The Astrophysical Journal, 69, 245–274 \(1929\)](#)

<sup>85</sup> W. de Sitter, [B.A.N. 5, No.193, 211–218 \(1930\)](#)

<sup>86</sup> W. de Sitter, [B.A.N. 6, 223, p. 146 \(1931\)](#)

<sup>87</sup> W. de Sitter, [PASP, 44, No.258, 89–104 \(1932\)](#)

<sup>88</sup> A. Einstein, W. de Sitter, [PNAS 18, 213–214 \(1932\)](#)

Sitter space continues without limits at decelerating velocity due to the work done by expansion against gravitation.

In his article *On distance, magnitude, and related quantities in expanding universe*<sup>89</sup> in 1934, de Sitter derives, among other things, an expression for *astronomical distance* or *optical distance* applicable to the observation of the angular size of cosmological objects. For deriving an expression for magnitude, he studies the effects of the Doppler shift due to the recession velocity, and the effect of Planck's equation on the observed power density of light from the objects. His interpretation is that the power density of radiation decreases "... as a direct result of Planck's fundamental equation  $E=hf$  and the fact that fewer quanta reach the eye of the observer...". The same conclusion was also made by Richard Tolman in his paper *On the Estimation of Distances in a Curved Universe with a Non-Static Line Element*<sup>90</sup> in 1930, Hubble and Humason in their article *The Velocity-Distance Relation among Extra-Galactic Nebulae*<sup>91</sup> in 1931, and H. P. Robertson in his article *The apparent luminosity of a receding nebula*<sup>92</sup> in 1938.

### *The FLRW cosmology*

Physicists and mathematicians of the 1930s faced an exceptionally challenging task in combining the results and conclusions from the special theory of relativity, the general theory of relativity, the solutions of Friedmann and Lemaître, Hubble's observations, Planck's equation, and the developing quantum mechanics into a workable cosmology model. The modern cosmology model, the *FLRW (Friedmann–Lemaître–Robertson–Walker)* model is named according to Friedmann and Lemaître, and the American mathematicians Howard Robertson and Arthur Walker, who made remarkable further contributions to the model.

Friedmann's and Lemaître's solutions allowed many options for the geometry and the development of space; the meaning of geometry, on the other hand, was dimmed by the concept of spacetime with time as the fourth dimension. Identification of the best alternative required a link between the observations and the structural parameters of the model. Some central predictions derived were those for the distance as a function of the redshift, the angular size of objects, the surface brightness, and the magnitude. Both the theory and the observations supported expanding space. It became more and more obvious that the estimates of the dimensions of space had to be re-evaluated.

In expanding space, the definition of distances is challenging. In the FLRW cosmology, there are several definitions of distances, each one being dependent on the assumed mass density and the possible existence of "dark energy", corresponding to the cosmological constant. *Co-moving distance* means the physical distance of the object at the time of the observation. *Light time distance* means the length of the light path from the object to the observer. The *light time distance* is shorter than the co-moving distance because space has expanded during the propagation of light. *Angular size distance*, important in optical observations, is obtained by dividing the *co-moving*

<sup>89</sup> W. de Sitter, [B.A.N. 7, 205, No. 261 \(1934\)](#)

<sup>90</sup> R. Tolman, [PNAS 16, 511, 1930](#)

<sup>91</sup> E. Hubble, M. Humason, [Astrophys.J., 74, 43 \(1931\)](#)

<sup>92</sup> H.P. Robertson, [Zs.f.Ap., 15, 69 \(1938\)](#)

distance by the expansion factor  $(1+z)$ . This means that the *angular size distance* turns to shortening at high redshifts.

*Luminosity distance* means the distance that results in an inverse square dimming of the light from the object; it is derived from the *co-moving distance* assuming that the dilution of the power density of radiation due to redshift is proportional to the second power of the expansion factor  $(1+z)$ , Figure 1-29.

The increase of distances in space results in an increase of the wavelength of light propagating in space. In the FLRW model the size of local gravitational systems like galaxies and quasars do not expand with the expansion of space; they conserve their dimensions but the distances between them increase due to the expansion.

In his paper, *On the Estimation of Distances in a Curved Universe with a Non-Static Line Element*<sup>93</sup> published in 1930, Richard Tolman derived predictions for luminosity distance and surface brightness. The prediction for the surface brightness is known as the *Tolman test* for expanding space – according to *Tolman’s test* a characteristic feature of expanding space is the dimming of surface brightness in proportion to the factor  $(1+z)^4$ . The result is subject to the assumption that the surface area of the object studied is independent of the expansion of space. A further assumption is that the redshift results in a double effect on the power density of light – due to the Planck equation and a slowed arrival rate of the light quanta. Accordingly, one of the  $(1+z)^2$

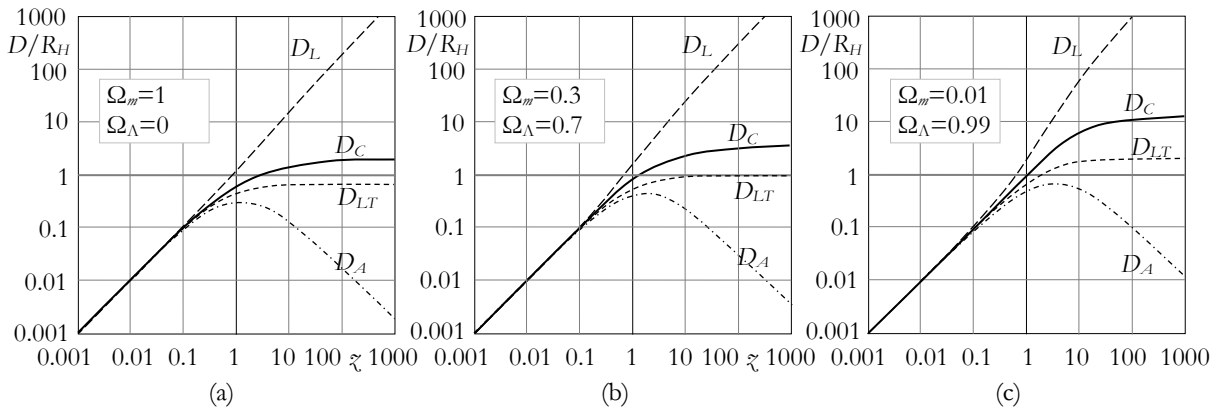

Figure 1-29. Central definitions of distances in FLRW-space for three combinations of mass density and dark energy. Each case assumes the “flat space” condition which means that the sum of the two density parameters is equal to one,  $\Omega_m + \Omega_\Lambda = 1$ . The *Co-moving distance*  $D_C$ , which means the physical distance at the time of observation, is obtained from Friedmann’s solution to the field equations of the general theory of relativity. The *Light-time distance*,  $D_{LT}$  is the length of the light path from the object to the observer in the expanding space. In principle, the *Light-time distance* approaches the Hubble radius  $R_H$  at very high redshifts that occurs in case (b), which has the currently preferred values of the density parameters,  $\Omega_m=0.3$  and  $\Omega_\Lambda=0.7$ . The *Angular size distance*  $D_A$  is obtained by dividing the *Co-moving distance*  $D_C$  with the expansion factor  $(1+z)$ , which means the distance of the object at the instant the light is left from the object. The *Luminosity distance*  $D_L$  is obtained by multiplying the *Co-moving distance*  $D_C$  by the expansion factor  $(1+z)$ , which gives the effect of the increased wavelength on the dilution of the power density. The power density of radiation is proportional to the square of the inverse of the *Luminosity distance*  $D_L$ .

<sup>93</sup> R. Tolman, [PNAS 16, 511-520, 1930](#)

factors in Tolman's test comes from the effects of the redshift and the other  $(1+z)^2$  factor from the apparent increase of the angular area due to the decrease of the angular size distance. Optically, the FLRW space differs remarkably from Euclidean space, where the observed angular area of a standard object is seen reducing in inverse proportion to the square of the distance, which in terms of the redshift means reduction by a factor  $(1+z)^2$ .

The increase of the angular size with an increasing distance comes from the derivation of the angular size distance, which uses the reciprocity assumption related to the special theory of relativity. The reciprocity theorem was introduced by the English physicist I.M.H. Etherington in his publication *On the definition of distance in general relativity* <sup>94</sup>, published in 1933. The reciprocity theorem requires that the angle, in which the object is seen, is unchanged if the roles of the observer and the object are transposed. The reciprocity theorem is assumed to be generally valid in the FLRW cosmology. The angular size of standard area (like galaxies in the FLRW cosmology) is derived from the angular size distance depend on the Hubble constant, describing the expansion velocity, and the density parameter  $\Omega$ , Figure 1-30.

According to present interpretations, the sum of the density parameter equals to one ( $\Omega = \Omega_m + \Omega_\Lambda = 1$ ). The portion of the visible and dark matter is  $\Omega_m = 0.27$  and the portion of the unknown "dark energy"  $\Omega_\Lambda = 0.73$ . The hypothesis of dark energy comes primarily from recent observations of the magnitude and redshift of supernova explosions; the prediction of the magnitude versus redshift fits best with observations with the given values of  $\Omega_m$  and  $\Omega_\Lambda$ . The present estimate for the Hubble constant is about 70 [km/s/Mpc] that, in the FLRW space, corresponds to about 13.7 billion years of age of the expanding universe. As late as in the 1950s the estimated age of the universe was only about 5 billion years <sup>95</sup>.

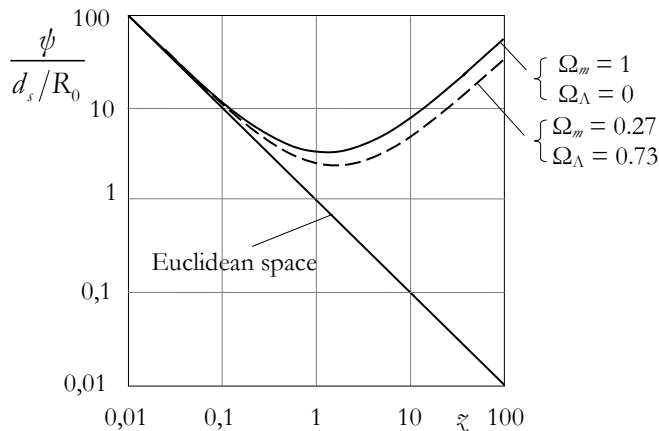

Figure 1-30. Angular diameters observed from standard size objects in FLRW-space. The curves are given for two sets of the density parameters. The combination  $\Omega_m = 0.27$  and  $\Omega_\Lambda = 0.73$  corresponds to present understanding of the parameters.

<sup>94</sup> Etherington, I.M.H.: *On the definition of distance in general relativity*. Phil. Mag. ser. 7 **15**, 761–773 (1933), [Phil. Mag. ser. 7 15, 761–773 \(1933\)](#)

<sup>95</sup> H.P. Robertson, *On the Foundations of Relativistic Cosmology*, [PASP 67, 82, \(1955\)](#)

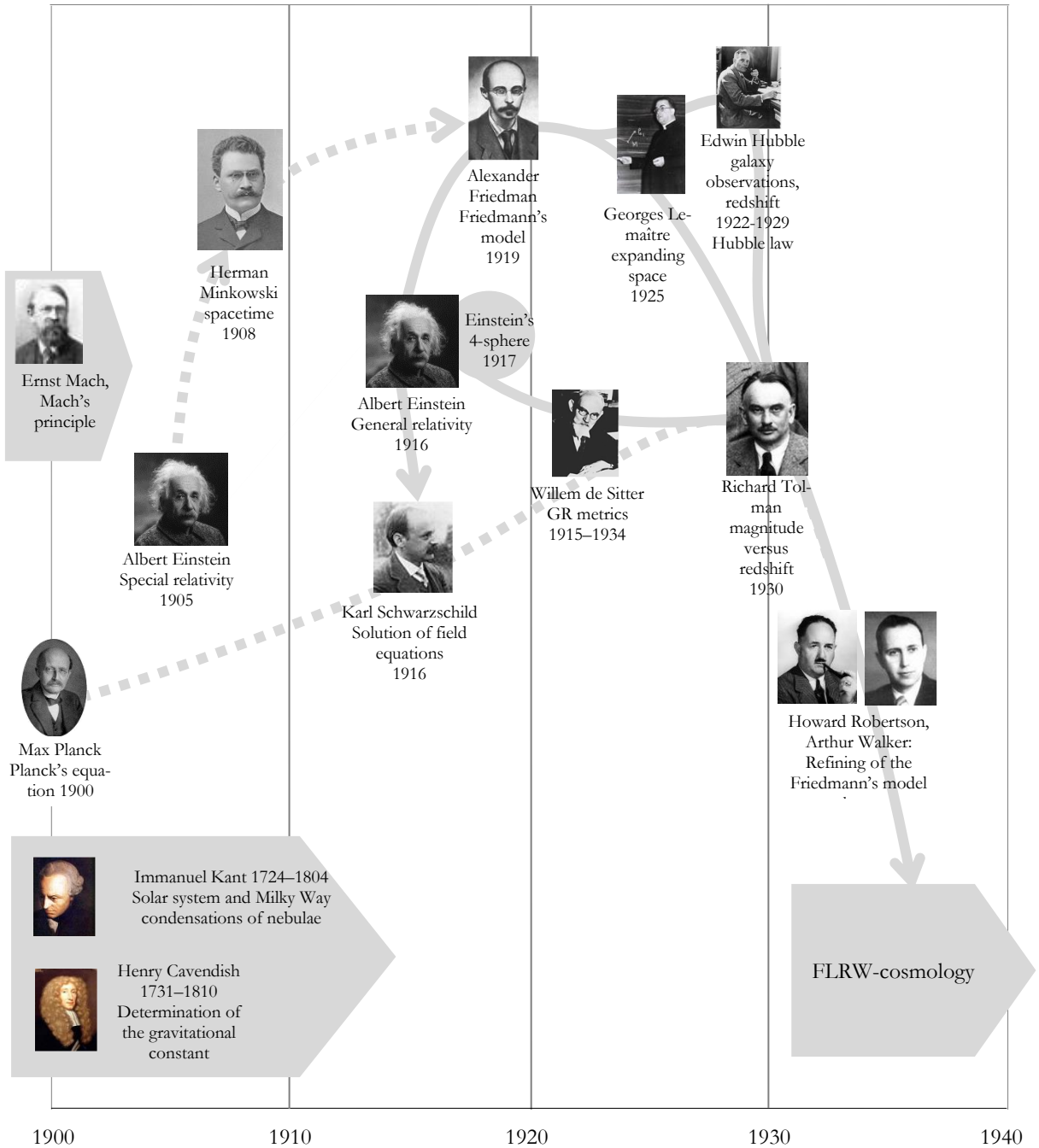

Figure 1-31. From general relativity to the FLRW cosmology. The FLRW cosmology, named after Friedmann, Lemaître, Robertson and Walker, has become the standard cosmological interpretation of the general theory of relativity. In addition to the general theory of relativity, the interpretation of Planck's equation has an important role in the predictions for cosmological observations.



The development of the FLRW cosmology is illustrated in Figure 1-31. The concept of the initial explosion, the Big Bang, as the beginning of space and time, was understood as getting remarkable confirmation by the observations of cosmic background radiation in 1964. In their experimentation with radars, the American radar engineers Arno Penzias and Robert Wilson observed that free skies send low wavelength microwave radiation uniformly from all directions. The frequency spectrum and the energy density corresponded, with high accuracy, to black body radiation *within* a cavity at 2.725 K. The radiation was interpreted as the afterglow of the Big Bang as predicted by the Russian theoretical physicist and cosmologist George Gamov in 1940s. The background radiation is assumed to date from about 380 000 years after the Big Bang, which meant that the radiation is redshifted by a factor of about 1100 during the propagation in space.

In the FLRW cosmology, the Planck equation is interpreted as an inherent property of radiation (instead of a property of the emission phenomenon). A consequence is that the dilution of the energy density of radiation appears proportional to the fourth power of the redshift factor  $(1+z)$ , which makes the “cooling” of the radiation follow the dilution of the energy density of the radiation in a cooling black body cavity. In an energy analysis this means that the total energy of the background radiation has diminished by the factor of 1100 from the energy it had when the radiation was freed. The present energy density of the background radiation is  $4.2 \cdot 10^{-14} \text{ J/m}^3$ , which is about  $10^{-4}$  of the average energy density in space. Observing the dilution, we can conclude that the share of the radiation at the time the radiation was freed has been about  $1100 \cdot 10^{-4} \approx 10\%$  of the total energy density in space. Accordingly, the redshift of the background radiation has wasted 10% of the total energy in space.

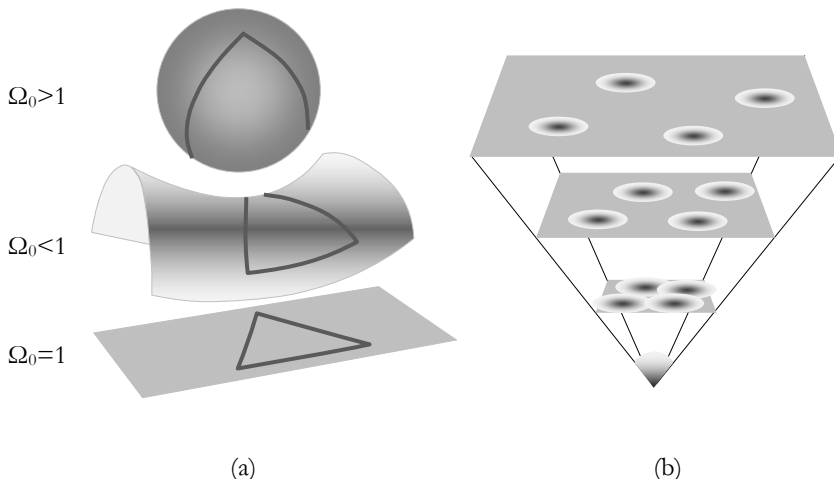

Figure 1-32. (a) In the FLRW cosmology the geometry of space is determined by the value of the density parameter  $\Omega$ , which may be equal to one, or higher or lower than one. When  $\Omega=1$  the space is “flat”.  $\Omega>1$  means closed space characterized by positive curvature, and  $\Omega<1$  means open space characterized by negative curvature. (b) Galaxies are assumed to conserve their size in expanding space. Figures, *Wikimedia Commons*.

It is very difficult to illustrate the geometry or the shape of the FLRW space. Mathematically, it is described as a three-dimensional structure developing with time. It may be closed, “flat” or open, depending on the mass density. “Flatness” means balance between the motion of the expansion and the gravity of mass in space, Figures 1-32 and 1-33.

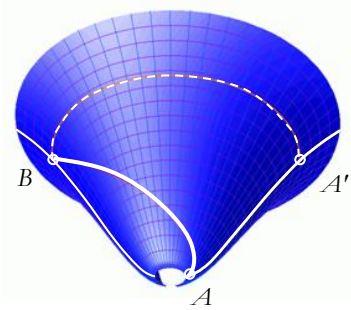

Figure 1-33. FLRW spacetime can be illustrated with a bell-shape cone where the height of the cone represents time, the open top of the cone describes the state after the inflation period. At any time, the 3-dimensional space appears as the circumference of the bell surface. Widening of the bell-surface (relative to a cone) describes the assumed acceleration of the expansion. Light leaving point  $A$  just after the inflation reaches the observer at point  $B$  at the same time as the light source has proceeded to point  $A'$ . The distance traveled by the light is shorter than the distance  $A'B$  from the light source to the observer at the time of observation.

Figure, *Wikimedia Commons*.

## 2. Basic concepts

The history of science introduced in Chapter 1 was restricted to “physical reality” excluding “living nature” and the development of life and consciousness – without consideration of the essence or justification of such a separation. In classical metaphysics, all first causes, including both the “lifeless” and living nature, are related to mythical or religious traditions regarding the causes and purposes of existence. Conception and understanding of material existence and the laws of nature behind material processes are conveyed by the models of celestial mechanisms and space, matter, and motion.

Since antiquity, existence has been understood either as eternal without beginning, end or boundaries – or as a finite entity with birth, development, and fading or destruction according to laws to be identified. The early philosophers, Thales, Anaximander, and Anaximenes tried to base their explanations of natural phenomena on observed regularities without the divine presence or supernatural guidance. Anaximander taught that the universe originates in the separation of opposites in the primordial matter Apeiron; that the cosmic order is controlled by balance and harmony; and that the individual parts are changing but the whole is conserved. Heraclitus spoke about the common basis and the law of nature, logos, behind everything; existence is expressed via continuous change and the harmony of opposites. Changes reflected the laws of conservation: “*The amount of rain is equal to the amount of water evaporated*”.

Anaxagoras shared the holistic view of Heraclitus: “*Everything is a part of the same whole*” or “*everything has its share of wholeness*”. The ideas of the atomists removed the local from the whole. However, two thousand years later, Leibniz’s monad reflected Anaxagoras’s ideas of the linkage between local and the whole; “*monad is a perpetual living mirror of the universe*”<sup>96</sup>. Mathematically, the idea of the local as the mirror of the whole (or the rest) is reflected, for example, in Fourier transformation; the Fourier transformation of a local delta function is a function equally everywhere – like the inverse of zero, which is infinite.

The central topics in antique natural sciences were matter, motion, and space. The underlying metaphysical principles were seen in regularities, mathematical beauty, the harmony of opposites, and the identification of the first causes. Since the antique era, the description of matter and motion stayed at an abstract and idealistic level for almost two thousand years. The description of space and the celestial bodies was more like the opposite; the Ptolemaic sky was just a description of the observations without a holistic view of the structure and the mechanisms of the celestial objects and their motion.

The most valuable inheritances from the antique sciences are probably related to metaphysics and the scientific principles, Aristotle saw that “...*the most exact of the*

---

<sup>96</sup> G. Leibniz, *Monadology*, <http://www.earlymoderntexts.com/pdf/leibmona.pdf>

*sciences are those which deal mostly with first principles; for those which involve fewer principles are more exact than those which involve additional principles...<sup>97</sup>*” – a principle that has been repeated throughout the history of science, and perhaps is better known as Occam’s razor than Aristotle’s criterion for qualified science.

The breakthrough of empirical sciences and mathematical physics triggered by the Copernican revolution underlines the importance of the interaction between a holistic perspective, accurate observations, and precise mathematical descriptions. As stated by Copernicus in the preface of his *De Revolutionibus*, he justifies the spherical symmetry of the universe and the solar system by the perfection and simplicity of the spherical form. To confirm this view, he tried to fit old observations into the heliocentric model and studied the consequences that resulted from his assumed motions of the celestial bodies. Later, Kepler found precise mathematical expressions for Copernicus’s planetary structure and the orbital motions.

Kepler was looking for mathematical beauty that he saw as a primary principle of nature. Kepler’s elliptic orbits fulfilled both the demand of mathematical beauty and precise fit with Tycho Brahe’s accurate observations. Kepler was not able to find the physical basis of the elliptic orbits; however, he discovered *Kepler’s laws* that related the orbital periods of the planets to their major axis, and the orbital propagation times to the areas of the orbital sectors covered.

Newton faced the challenge of finding the physical basis behind Kepler’s ellipses – which required fundamental preliminary work for defining the necessary physical quantities like force, mass, momentum, acceleration and inertia and for combining the quantities into usable laws of motion. For identifying the force of gravitation, Newton was looking for the centripetal force that, when linked to the inertia of the planet, would result in Keplerian elliptic orbit.

The process formed by the works of Copernicus, Kepler and Newton illustrates the importance of an unbroken chain from metaphysical principles through empirical observations to mathematical modeling and reconfirming of the postulates and the predictions. In astronomy, direct modeling of observations led to the Ptolemaic model. Combining the system outlined by Copernicus and the mathematical intuition and analysis of observations by Kepler, Newton was able to identify the mechanical laws behind the system and to develop the necessary mathematics needed for the introduction of a complete mathematical theory of mechanics. The concept of force obtained the status of a primary physical quantity, status, that has survived until today – the search for a unified theory has focused to the linkage of strong, weak, electromagnetic and gravitational forces.

### *Matter and motion*

Since antique, the main lines of the development of physics have directed to matter and motion. In today’s physics, the description of matter starts from elementary particles studied as particle physics applying quantum mechanics and special relativity and quantum field theory. Interactions between atoms and molecules fall in the

---

<sup>97</sup> [Aristotle, \*Metaphysics\*, Book 1, part 2](#)

scope of chemistry with roots in experimental finding and theoretical bases in the conservation of mass and, since the late 19th century thermodynamics. In modern quantum physics, chemical bonds and atomic structures are studied in quantum chemistry.

Figure 2-1 summarizes the central development steps in the description of matter. After many steps, the abstract apeiron has been replaced with an abstract wave function, the square of which describes the probability of the instantaneous location of a particle. The wave function is a dimensionless function with the integral over whole space equal to one, which means that the probability of finding the particle somewhere in space is one.

Wavefunction and the concept of probability challenged the indeterminism which means that at least some events cannot be determined from a pre-existing situation or known laws of physics. Description of the Big Bang as a quantum fluctuation is probably an attempt to link the event to “quantum probability”. The stochastic nature of quantum effects has supported the current reductionistic picture of reality assuming that the whole is the sum of at least partly stochastic local events.

The wave nature of a particle made the essence of mass and matter even more abstract than the abstract apeiron. Some of the properties of matter are explained in terms of particle-like properties, another part as wave-like properties. Vice versa, certain properties of light, like the photoelectric effect, are described in terms of particle-like photons proposed by Albert Einstein in 1905 by interpreting the energy quantum in Planck’s equation as a localized burst of radiation or a light particle.

Since Newton’s Optics in 1704, the theory of light as a particle stream lived firmly in the 18th century even though Christiaan Huygens had explained refraction and interference by a wave description. The experiments by Thomas Young and Augustin-Jean Fresnel convinced the 19th-century physicists of the wave nature of light; the final seal for the wave theory was given by the identification of light as a form of electromagnetic waves described by Maxwell’s equations.

Quantum mechanics has mainly supported the reductionistic view of reality. The wave packet description of a free particle is a constructive superposition of waves with all wavelengths and unconstructive superposition extending to infinity out outside the particle. In a broad perspective, the waves have the potential for a constructive superposition anywhere in space which links the local to the rest of space which may be interpreted at least a holistic feature.

The wave packet or the waves themselves do not describe the particle or its energy but the probability of the location the particle is observed. On an experimental level, the wave nature of matter is characterized by the Compton and de Broglie wavelengths linking the particle to the rest energy, momentum, and electromagnetic radiation or photons.

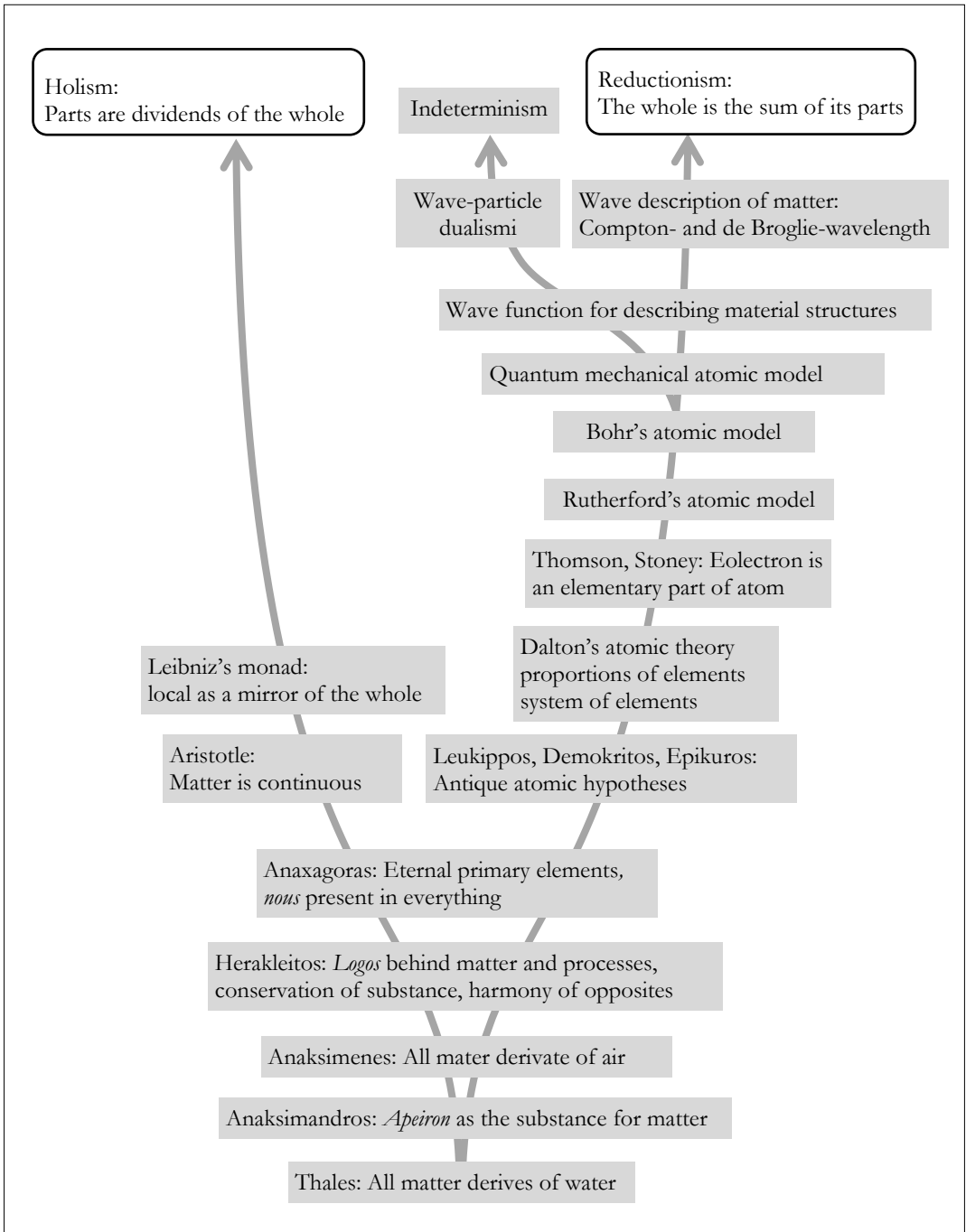

Figure 2-1. From water and the abstract *apeiron* to abstract wave function and a reductionistic picture of reality.

*Mass and radiation*

There is no united description of the particle- and the wavelike properties of light – nor the wave- and particle-like properties of mass particles in quantum mechanics, Figure 2-2. In the framework of relativity, a photon (the particle expression of light) and a mass particle differ in rest energy, momentum, and kinetic energy; the rest energy of a photon is zero, and the kinetic energy is

$$E = h f = \frac{h}{\lambda} c = \frac{\hbar k}{c} c^2 \quad (2.1)$$

The momentum of a photon is

$$\mathbf{p} = \frac{E}{c} \hat{\mathbf{r}} = \frac{h}{\lambda} \hat{\mathbf{r}} = \hbar \mathbf{k} = \frac{\hbar}{c} \mathbf{k} \cdot c \quad (2.2)$$

where  $\hat{\mathbf{r}}$  is the unit vector and  $\mathbf{k}$  the wavenumber vector. The quantity  $\hbar k/c$  has the dimension of mass [kg], which means that the energy of a photon can be expressed in terms of the “mass equivalence”  $m_\lambda = \hbar k/c$  and the velocity of light like the energy of a mass object with mass  $m_\lambda$

$$E = m_\lambda c^2 \quad (2.3)$$

which can be expressed in terms of the Compton wavelength  $\lambda_C$  and the corresponding wave number  $k_C$  as

$$E = m c^2 = \frac{h}{c \lambda_C} c^2 = \frac{\hbar}{c} k_C \cdot c^2 \quad (2.4)$$

which is formally identical with the energy of motion of a photon with wavelength  $\lambda_C$  and wavenumber  $k_C$ .

Newton’s equation of motion,  $F = ma$ , defined mass as the property that determined the inertial force of the object. In *Principia*, Newton defined gravitation as a property that is proportional to the mass (as the amount of material), which meant that both the inertial force and the gravitational force were proportional to mass and properties defining mass.

The definition of mass was complicated in the late 19th century when the inertial property of electrons was observed to increase with the increasing velocity of the electron. The special theory of relativity defined the mass of a moving object as the relativistic mass that increases without limits when the velocity approaches the velocity of light.

The equivalence principle behind the general theory of relativity requires that the inertial mass and the gravitational mass shall be the same. It means that the gravitational mass increases with the increase of the relativistic mass of a moving mass object. Such dependence has a dramatic effect in extreme gravitational conditions like in the vicinity of local singularities, black holes, in space.

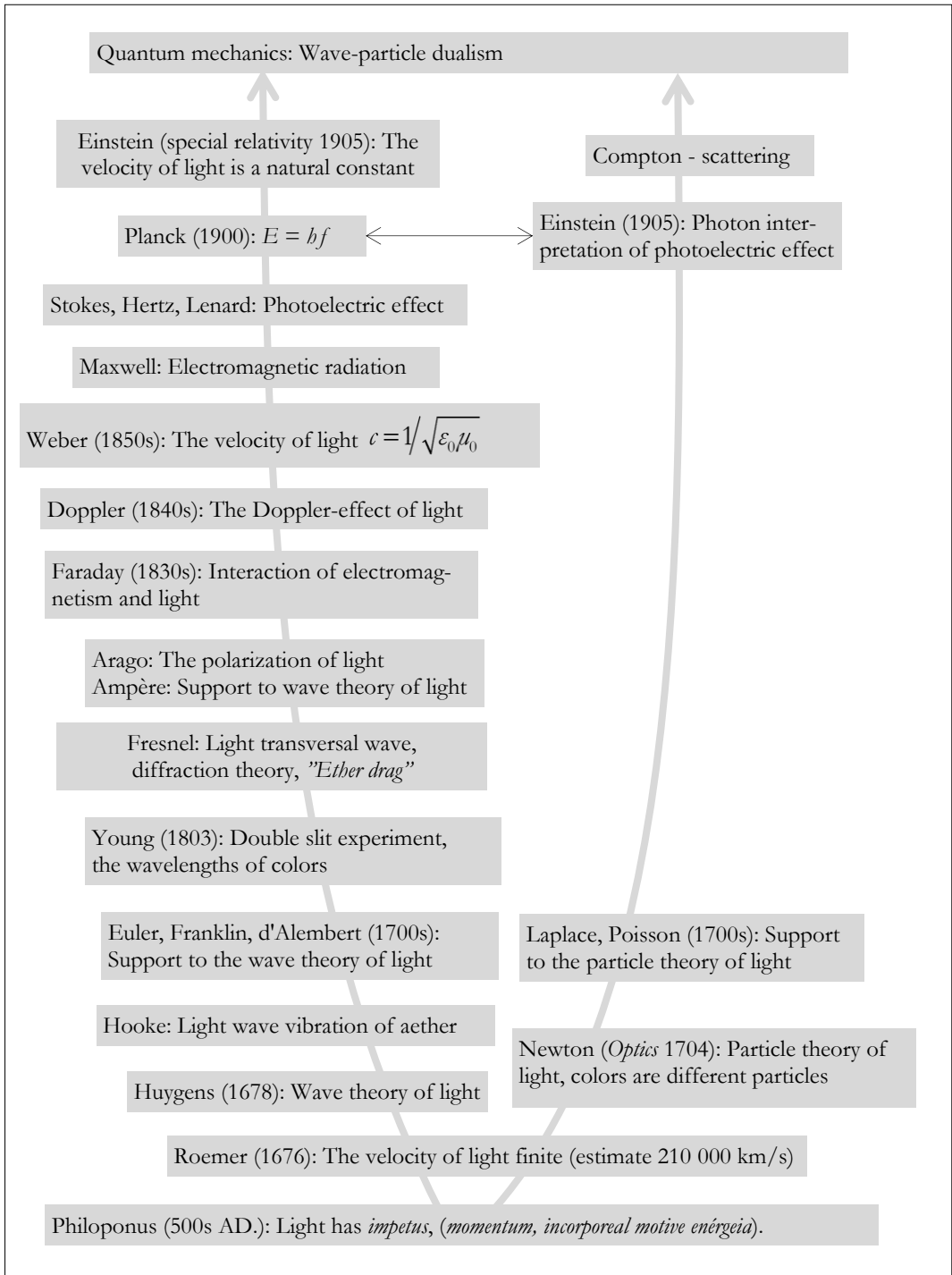

Figure 2-2. Development steps in the description of light: From waves and particles to wave-particle dualism.



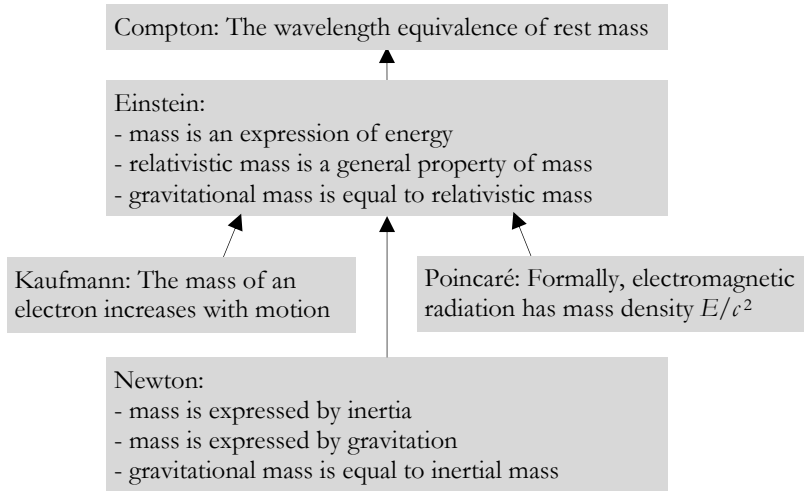

Figure 2-3. Development steps in the definition of mass. Since Newton's equations the definition of mass has been based on the properties of mass objects – the most important of those are inertia and gravitation. The concept of rest energy gave the interpretation of mass as an expression of energy.

The classical definition of mass was based on inertia and gravitation. The theory of relativity added the concept of rest mass that allowed the definition of mass as an expression of energy. Quantum mechanics does not give an explicit definition of mass but links mass to the Compton wavelength.

As illustrated in Figure 2-3, mass has become defined in terms of force, motion, and energy. In a metaphysical perspective, the definition of mass in terms of force refers to a local interaction; a definition based on energy links mass to conservation laws.

### *Force, momentum, and kinetic energy*

In Aristotle's metaphysics motion was obtained by actualizing potentiality. Motion was maintained by movent proportional to velocity and opposed by the resistance of the medium; "If an ox stops drawing a plough, the plough stops". In Aristotle's physics free fall due to gravitation was natural motion taking the object to its natural place at a velocity that is proportional to the weight of the object. In a broad sense, Aristotle's natural motion can be interpreted as a tendency towards minimum potential energy, which is also the case when light objects move upwards by being replaced by heavier air.

The movent of Aristotle's forced motion was understood as an external factor. The first, who understood movent as an internal property of the moving object was probably John Philoponus, theologian, philosopher, and polymath in Alexandria in the 6th century AD. He thought that motion was maintained by the "energy of motion" (incorporeal motive *enérgeia*), impetus that the moving object received from the source of the motion. Motion continues as long as impetus is not removed. The

resistance of air or work against gravity removes impetus thus resulting in slowing or stopping of the motion. According to Philoponus, planets moving in their orbits in empty space are not subject to the resistance of air, and therefore they maintain their impetus, velocity, and the orbit. Philoponus assumed that the propagation of non-material light carries impetus.

The concept of impetus was next developed – about one thousand years later – by the French priest and philosopher Jean Buridan in 1300s. Qualitatively, Buridan identified impetus as momentum. Reconsideration of Aristotle's natural/forced motion had to wait for Galileo Galilei's experiments with a pendulum and falling objects in the late 1500s. Galilei's experiments and his conclusions created a firm basis for the works of René Descartes, Christiaan Huygens, Gottfried Leibniz, and Isaac Newton for identifying the central quantities characterizing motion.

René Descartes defined momentum as the product of velocity and the “size” of the object. Also, he postulated the conservation of momentum in elastic collisions. Christiaan Huygens and Gottfried Leibniz defined momentum as the product of velocity and mass. Leibniz concluded, based on Galilei's, and his own experiments, that the “living force”, *vis viva*, that a falling object gets from gravitation is not the momentum,  $mv$ , but a quantity proportional to the second power of velocity,  $mv^2$ .

Leibniz defended strongly the conservation of *vis viva* (in modern terms, kinetic energy). The philosophy behind the conservation of *vis viva* was closely related to Aristotle's *entelecheia*, or actualization of potentiality – most concretely seen in the cases of a pendulum and falling objects. In the case of elastic collision, Leibniz assumed, that living force is first accumulated into “dead force”, *vis mortua*, in the elasticity of the material, and then converted back to living force at the release of the tension in the material. The conservation of the sum of the potential energy and the kinetic energy, as identified by Leibniz, was understood as a central principle in energetics and thermodynamics in late 1800s.

Isaac Newton's successful solution of celestial mechanics and the equations of motion behind it directed the description of motion primarily on mathematics based on force and acceleration as the basic quantities. Laplace's, Lagrange's, and Hamilton's formalisms derived from Newton's equations of motion implicitly defined the concepts of energy and potential. The physical importance of energy as a main conservative was understood in late 1800's – force, however, continued to conserve its position as the primary quantity; energy became a derived quantity as integrated force.

#### *From linear world to unlinear world*

The Newtonian world was linear, unlimited and infinite – Newton himself, however, avoided defining the space or emptiness behind the sphere of fixed stars. Although the Sun, or more precisely, the barycenter of the solar system presented the center and the absolute reference at rest, the Newtonian equations of motion implicitly defined a local state of rest wherever they were applied on the Earth rotating around its axis and revolving around the Sun.

In the Newtonian world, the velocity of an object increases linearly as long as there is a constant force acting on the object. In the late 1800s, observations on the

coupling of the velocity of light to the velocity of the observer and the object, gave the impression that the velocity of light has a special role as the maximum velocity obtainable in space. More support was obtained from the velocity of electrons accelerated in cathode ray tubes; at high velocities the increase in their velocity was less than predicted by the linear Newtonian equation of motion. The non-linearity was interpreted as an increase in the mass of the electron, probably towards infinity when the velocity approaches the velocity of light.

For describing the observations, local space and time were modified by coordinate transformations affected by the velocity of the object observed. Originally, the transformations were coupled with possible changes in the structure and dimensions of the material in motion. In his special theory of relativity Einstein postulated the Lorentz transformation as a consequence of the principle of relativity and a property of reality. In the relativistic Einsteinian world, the velocity of an observer is added to the velocity of the observed motion in a non-linear manner so that the sum of the two velocities never exceeds the velocity of light. The definition of the velocity of light as a natural invariant required time to be a variable that, in Herman Minkowski's interpretation, can be seen as the measuring rod of the fourth dimension perpendicular to the three space dimensions.

The special theory of relativity produced new expressions for momentum and kinetic energy and created the concepts of rest energy and rest mass that allow the interpretation of mass as a form of energy. The non-linear increase of momentum was interpreted as a property of momentum or "relativistic mass".

Figure 2-4 summarizes some development steps in the description of motion. Aristotle's *entelecheia* reminds of the cause of the motion that in the case of free fall is the gravitational energy released. Philoponus realized that the *impetus* maintaining the motion is obtained from the cause of the motion, equally in free fall and in "forced motion". The development of the description of motion was guided, for a long time, by Newton's laws based on the concepts of force, action and reaction, acceleration, and a local state of rest as formulated in Principia. The principle of action and reaction can be interpreted as a local manifestation of the conservation of energy, as illustrated in Lagrange's and Hamilton's formalisms.

Galileo Galilei's concepts of the state of rest and the relativity principle were inherited into Einstein's special theory of relativity which, however, required additional postulates like the constancy of the velocity of light and the Lorentz transformation.

The energy principle requires the definition of the system studied; motion is obtained via the energy released by the accelerating system. In a closed system, the state of rest is defined as the state where the kinetic energy of an object in the system is zero. In celestial mechanics, the state of rest fulfills the definition of the state of rest in a system.

The kinematic study of linear motion ignores the dynamics needed to obtain the motion, which has led to the acceptance of the relativity principle both in Newton's mechanics and the theory of relativity. The relativity principle allows the choice of any one of two objects moving relative to each other being defined as the reference at rest. The dynamic approach requires studying the system where the motion is obtained.

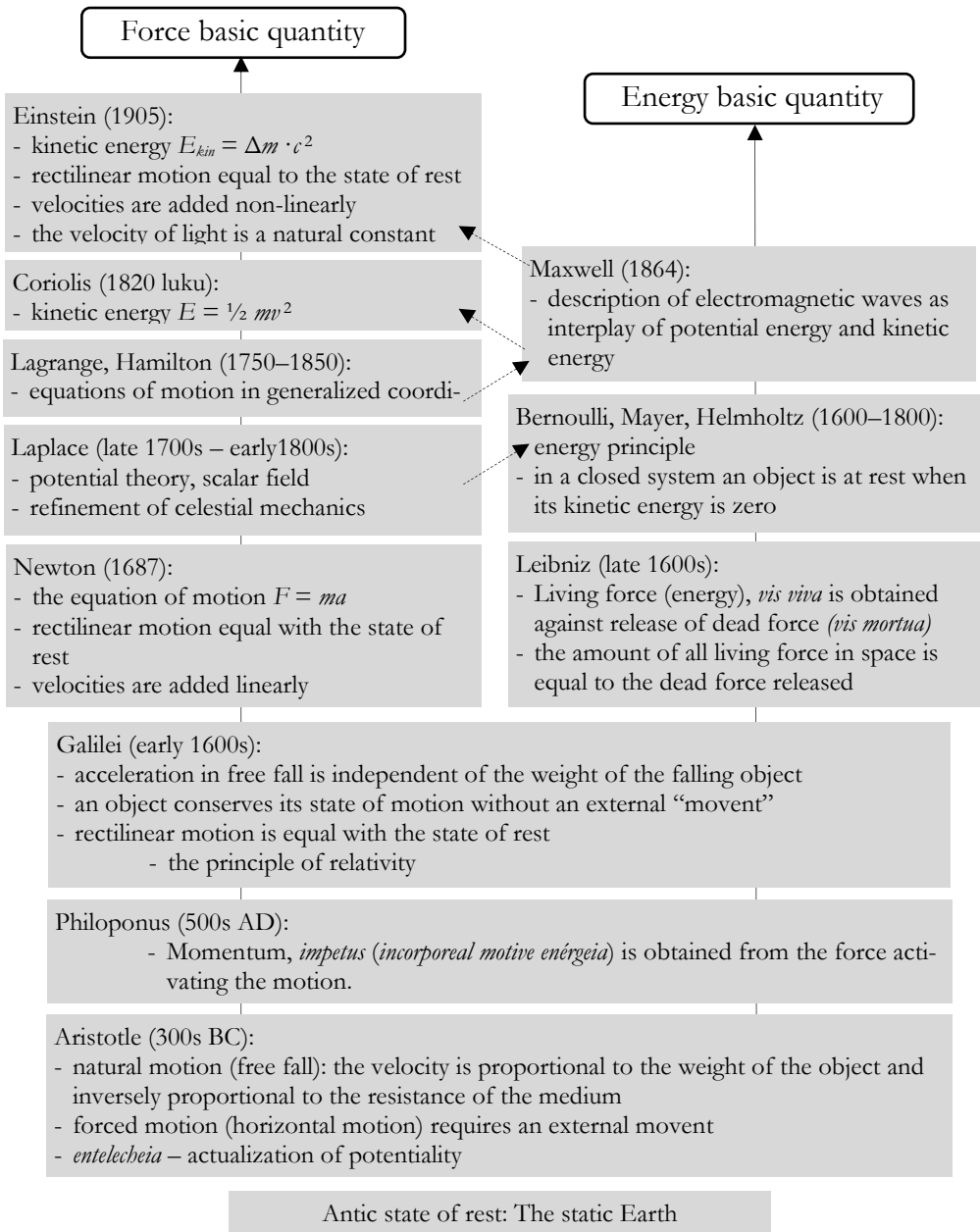

Figure 2-4. Development steps in the description of motion and the state of rest. The state of rest in antiquity was the static Earth at the center of the universe. Galilei assumed the equality of rectilinear motion and the state of rest, which authorized him to postulate the principle of relativity. According to the relativity principle, either one of two objects in relative motion can be considered as staying at rest. The principle of relativity was inherited by the special theory of relativity. In an energy-based study, the state of rest is characterized by zero kinetic energy in a system. Aristotle's *entelecheia*, actualization of potentiality was realized in Leibniz's *vis viva* obtained against a release of *vis mortua*, and in Maxwell's electromagnetic radiation where the energy is oscillating between potentiality and motion.

*From skies to cosmology*

In antique conception the Earth and the skies were eternal. Skies were surrounded by the sphere of fixed stars that, in principle, made space finite. The focus in astronomy was in the description of irregular planetary motions and phenomena with direct implications on the Earth. Description of planetary motions led to the complex system of epicycles, which was more or less a direct mathematical description of the observations without a metaphysical basis. In spite of its clear logic, the heliocentric system introduced by Aristarchus in the 200s BC did not receive support; the Earth-centered system was supported both by direct empirical evidence and religious tradition that continued for almost two thousand years and yet another two hundred years after Copernicus's carefully justified heliocentric system.

Conditions for a scientific approach to cosmology were not created until the early 20<sup>th</sup> century when observations at cosmological distances became possible, and the general theory of relativity offered a theoretical basis for the description of the structure and development of space. The term cosmology may have been introduced by the German philosopher Christian Wolff in his book *Cosmologia Generalis*, published in 1730<sup>98</sup>.

Philosophical ideas of galaxies, nebulae and the buildup of the solar system had been presented by, for example, Immanuel Kant, Thomas Wright, and Johann Lambert in the 18<sup>th</sup> century. The theoretical bases of modern cosmology and the predictions for observables are mainly based on observations and interpretations of the general theory of relativity between 1910 and 1940, Figure 2-5.

The general theory of relativity defined gravitation as a property of the geometry space-time locally determined by the interactions in the surrounding space. The interactions are described in the form of a stress-energy tensor. The linkage to celestial mechanics around a mass center is obtained with the Schwarzschild solution of GR wave equations. Boundary condition in Schwarzschild's solution is the Newtonian gravitation far from the mass center.

Nucleosynthesis, as a central part of the Big Bang cosmology, was presented by the Russian/American physicist George Gamov in the 1940s. Also, he predicted that the radiation originating from the Big Bang could be observable as highly redshifted black body radiation in space. Such radiation was observed in 1964 by the American engineers Arno Penzias and Robert Wilson in their experiments with radars. The Big Bang model has been further supplemented by the inflation theory for supporting the structural homogeneity of space and the low number of heavy elements created in the Big Bang.

---

<sup>98</sup> Christian Wolff, *Cosmologia Generalis* (1730) google book

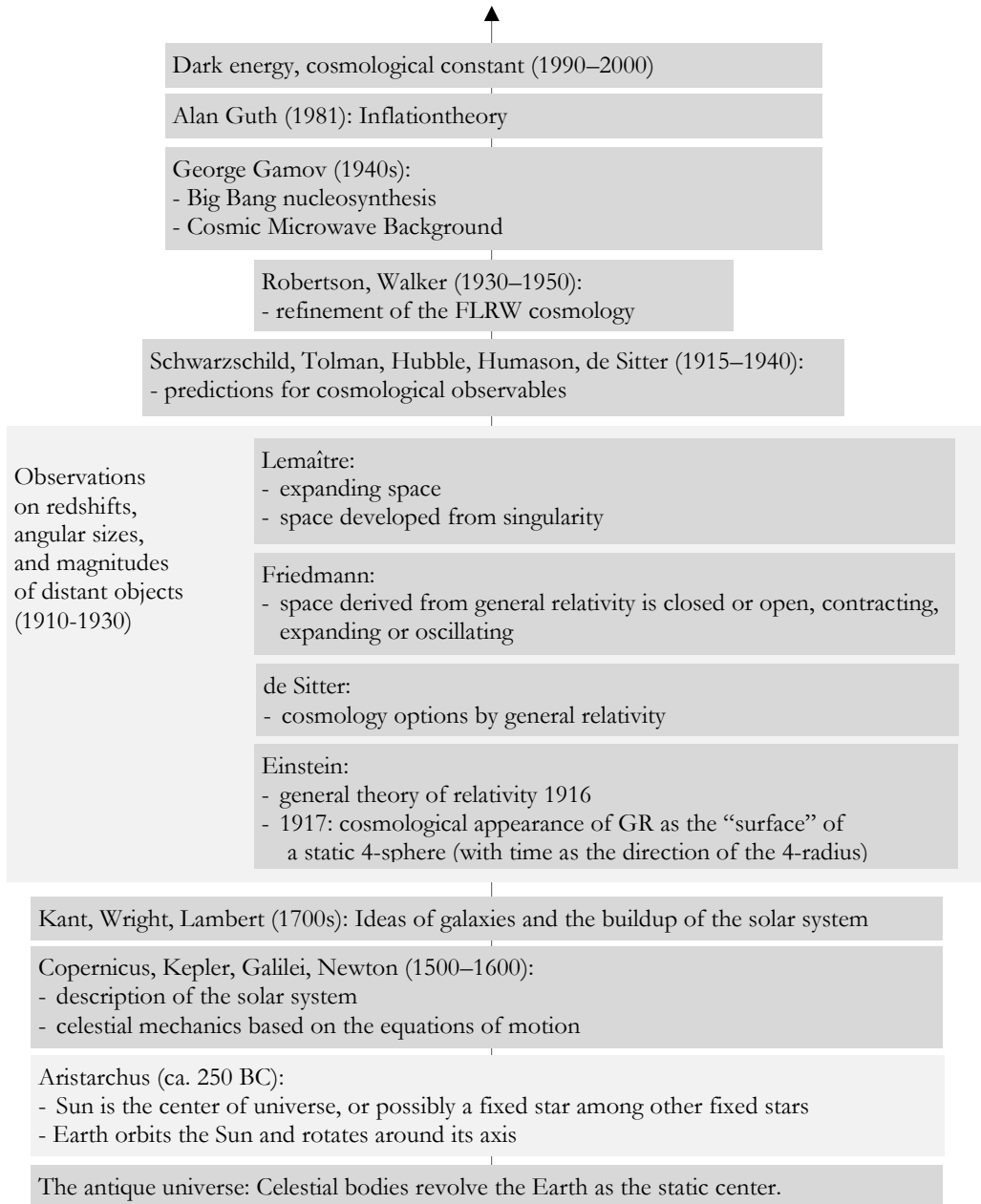

Figure 2-6. From the antique universe to Big Bang cosmology. The bases of the modern FLRW cosmology are built up mainly in 1910–1930. The cosmological model has been complemented by a detailed theory of nucleosynthesis that has been used for the modeling of the buildup of elements in the Big Bang and developing stars. For justifying the homogeneity of space at cosmological distances, the ongoing expansion has been complemented by a hypothetical early inflation phase when the expansion was extremely fast. To match the model with the observations made on the magnitudes and redshifts of supernova explosions in 1990–2010, the model was further complemented with hypothetical “dark energy” that worked like negative gravitation.

Based on the observations of redshifts and magnitudes of supernova explosions in the late 1990s and early 2000s, the Big Bang model was further complemented by a hypothetical “dark energy” affecting like negative gravitation. An optimum match of the prediction of magnitude versus redshift was obtained with an about 74% share of dark energy in the mass density in space. The share of dark mass is assumed to be 22% and the share of visible mass only about 4%. The presence and share of dark matter is mainly based on the rotation properties of galaxies; the orbital velocities of stars far from the center of galaxies require more central mass than stars rotating in the vicinity of centers. The masses of visible stars only can not explain the differences.

### **Postulates and definitions**

The roots of today’s theories are in postulates defined in the early 2000th century partly extending to the times of Galileo Galilei and Isaac Newton. Central postulates behind relativity theory are the relativity principle, equivalence principle, the constancy of the velocity of light, and Lorentz invariance that fixed the observational reality with relative time and distance required by the relativity theory.

Quantum mechanics introduced a new concept of probability and the quantization of quantities like energy, momentum and angular momentum. Also, quantum mechanics created the wave-particle dualism and the uncertainty principle which altogether removed quantum mechanics from the traditional physics framework.

The theory of relativity is derived using a kinematic procedure for explaining local observations. The correction the special theory of relativity brings to classical mechanics is based on transformations of the observational reality; the flow of time was linked to the observational situation; events in motion relative to the observer experience reduced the flow of time. The equivalence principle was postulated for extending the special theory of relativity to the general theory of relativity.

In the framework of general relativity, gravitation is described in terms of the geometry of space-time. Mass centers in space turn local space-time which results in reduced flow of time and increased distances close to the centers and a decreased coordinate distance to an observer far from the mass center. In GR space, free fall of a mass object results in a similar increase of mass as motion in special relativity.

At the time the theory of relativity was developed, there was no clock capable of measuring the effect of motion and gravitation on the ticking frequency. The theory behind the ticking frequency of atomic clocks or the characteristic emission and absorption frequencies of atoms was formulated as a part of the development of quantum mechanics since 1920s. First experiments on the effect of motion on the characteristic frequencies were made in the late 1930s. The use of atomic clocks for testing the theory of relativity activated in the 1960s. All experiments gave support to the predictions of special and general relativity which stabilized the idea of the lower flow of time experienced in motion relative to the observer or at a lower gravitational potential.

According to the quantum mechanical solution, the characteristic frequencies are determined by the energy states of the emitting electrons; the frequency is directly proportional to the difference of the quantum states determining the emission/absorption directly proportional to the rest energy of the oscillating electrons and inversely proportional to Planck's constant. According to postulates behind the relativity theory, the factors of the rest energy, the rest mass and the velocity of light as well as Planck's constant are constants which means that the only explanation to the different frequency was the effect of motion and gravitation on the flow of time.

Planck's constant is considered as a natural constant like the electrical constants. The special theory of relativity predicts an increase of the inertial mass by motion but conserves the rest mass constant. The equivalence principle links the gravitational mass to the inertial mass, which means that also the gravitational mass increases with motion. The constancy of the velocity of light is motivated as an "empirical fact", originally based on interferometric measurements and later on numerous experiments with atomic clock<sup>99,100,101,102</sup>.

The quantum mechanical solution of the characteristic frequencies of atoms binds the emission wavelength to Bohr's radius, i.e., the size of the emitting atom. The increase emission wavelength observed in emission from moving emitters mean increased size of the emitting atom, not only in the direction of the motion but conserving the shape of the atom. According to the special theory of relativity, an atom in motion conserves the emission wavelength for an observer moving with the atom and explains the increased wavelength observed by the observer at rest with the coordinate transformation needed for transmitting the observation to the frame at rest. The explanation is problematic if the observations made from the cumulative reading of the clock. Readings cumulated to clocks at different states of motion are different – they cannot be adjusted with coordinate transformations.

### *Interaction and*

In current physics, force is expressed as an implication of interaction. Interactions are transmitted by gauge bosons, force carriers, propagating at the velocity light. The standard model of particle physics recognizes four kinds of gauge bosons, photons for electromagnetic interactions, two types of bosons for weak interactions and gluons for the strong interaction. The possible existence of the gauge boson for carrying the gravitational interaction, the graviton, has not been identified. Immediate quantum entanglement observed with particle pairs challenges the concept of interaction conveyed at the velocity of light.

In the early 19th century, Laplace analyzed the stability of the planetary system and calculated the possibility of non-instant gravitational interaction. According to his calculations, the stability of the planetary system requires immediate or at least orders of magnitude faster gravitational interaction than the velocity of light. The gravitational interaction at the velocity of light required by general relativity challenged

<sup>99</sup> H.J. Hay, J.P. Schiffer, T.E. Cranshaw, and P.A. Egelstaff, *Phys. Rev. Letters* 4, 4 (1960) 165

<sup>100</sup> D.C. Champeney, G.R. Isaak, and A.M. Khan, *Nature* 198, 4886 (1963) 1186

<sup>101</sup> J.C. Hafele and R.E. Keating, *Science* 177 (1972) 166

<sup>102</sup> R.F.C. Vessot et al., *Phys. Rev. Letters*, 45, 26 (1980) 2081



Laplace's calculations. His analyses have been restudied applying the theory of relativity, an explicit answer, however, is still missing. The discussion on the speed of gravitation is dimmed by a possible difference between the velocity in direct interactions between masses and the propagation velocity of gravitational waves.

## Open questions

### *The picture of reality*

The most important open questions can be seen in the picture of reality conveyed by the existing theories – and the postulates behind the theories

The relativity of time and simultaneity are understandable in the mathematical sense but unconceivable by common sense. Mathematics with relative time meets problems with derived quantities like energy and momentum which need time as base quantity; the relativity of time confuses the concept of the conservation of energy. The relativity principle behind the relativity of time is such a central postulate behind the relativity theory that the status of the conservation of energy as a primary law of nature has been given up.

The interpretation of quantum mechanics and the underlying reality raise questions; the wave function central to quantum mechanics describes probabilities but lacks a concrete physical meaning. Quantum mechanics challenges the principle of causality via the quantum entanglement.

A major problem, creating a barrier between quantum mechanics and the theory of relativity comes from the different postulate basis of the two theory structures.

### *Cosmology and the general theory of relativity*

The FLRW cosmology derived from the general theory of relativity does not answer the question of the structure of space and the development of the expansion. The dark energy added to the theory lacks a physical explanation. Electromagnetic radiation propagating in space loose energy because Planck's equation is interpreted as an intrinsic property of radiation. A further open question in cosmology is the trigger of the Big Bang, the lack of anti-matter and the nature of dark matter.



### 3. Dynamic Universe

*The Dynamic Universe (DU) theory is the author's personal view of the description of physical reality. The roots of DU extend to my graduate student time in the late 1960s when I pondered on the problem of space-time: "Have we found the right coordinate system for the theories? Could we find a coordinate system relying on univocal meanings of time and distance." A breakthrough occurred in 1995 when I realized that the predictions of the relativity theory could be easily derived in absolute time once we notice that any motion in space is associated with the motion of space in the fourth dimension. The motion of space could be recognized as the expansion of space; following the original view of Einstein describing space as the 3D surface of a 4D sphere, and allowing expansion of the structure, all mass in space is subject to momentum and the corresponding energy of motion in the fourth dimension, perpendicular to the three space dimensions. It is the energy observed as the rest energy of mass in space. The fourth dimension shall not be understood as the direction of time but a metric dimension that obeys the same laws of nature as the three space directions. Spherically closed space works like a spherical pendulum; mass in space gets its energy from its own gravitation in a contraction phase and pays it back to gravitational energy in the ongoing expansion phase. Local structures, processes, and phenomena in space are described conserving the overall zero-energy balance of motion and gravitation in space. We don't need distorted time and distance for describing relativity; relativity is conveyed via the locally available energy. An atomic clock in motion or local gravitational interaction does not experience "slower flow of time" as in the theory of relativity but runs slower because part of its energy is bound to the local motion or gravitation. DU produces precise predictions both for local and cosmological observations – without dark energy or other experimental parameters. DU provides a holistic picture of reality and a theoretical framework offering an understandable ontological basis for quantum phenomena.*

### Unified expression of energy

*The connection between Planck's equation and Maxwell's equations*

The energy principle was a central factor in the unification of different areas in physics and chemistry in the 19th century. Maxwell succeeded in describing the observed electromagnetic phenomena in terms of kinetic and potential energy in a hypothetical aether – and interactions between related force fields. Maxwell's equations allow a detailed analysis of the energy conversion in the emission and absorption of electromagnetic radiation. Today's antenna theory relies on Maxwell's equations.

The basis behind Planck's equation was the idea of monochromatic oscillators or resonators as the emitters and absorbers in a black body cavity. In spite of his attempts, Max Planck did not find support for his idea from Maxwell's equations that he highly respected. The analysis of blackbody radiation looked problematic; if the radiation in a black body cavity is supposed to be formed from standing waves with any harmonic frequency, an unlimited increase of high frequencies would lead to the

so-called “ultraviolet catastrophe”, which means that the energy density in the system would increase without limits due to the high frequencies.

The Rayleigh-Jeans model was based on the wave equation of electromagnetic radiation that allows an unlimited number of harmonic frequencies. The model does not pay attention to the emission and absorption mechanisms at the walls of the black body cavity; the emitters and absorbers are free oscillators in a thermal balance with any frequency in the cavity.

Planck assumed that the emitters and absorbers are monochromatic oscillators with characteristic frequencies directly proportional to the thermal energy of the oscillator. When the thermal energy of the oscillators is assumed to follow the Boltzmann distribution, the number of high-frequency oscillators is reduced, and the ultraviolet catastrophe is avoided. In the simplest case, an oscillator can be described as an electric dipole – Maxwell’s equations allow the analysis of the energy emitted by a dipole in a cycle of electromagnetic radiation.

The linkage between Planck’s equation and Maxwell’s equations can be found by describing Planck’s monochromatic oscillators as dipoles with the length related to the wavelength emitted. By replacing the electric constant  $\epsilon_0$  with the magnetic constant  $\mu_0 = 1/\epsilon_0 c^2$ , the energy emitted into one cycle of radiation can be expressed as

$$E_\lambda = \frac{P}{f} = \frac{N^2 e^2 \xi_0^2 \mu_0 16\pi^4 f^4}{32\pi^2 r^2 c f} \frac{2}{3} 4\pi r^2 = N^2 \left( \frac{\xi_0}{\lambda} \right)^2 \frac{2}{3} (2\pi^3 e^2 \mu_0 c) f \quad (3.1)$$

where  $N$  is the number of electrons oscillating in the dipole,  $\xi_0$  is the length of the dipole,  $\lambda$  is the wavelength emitted,  $f$  is the frequency of the radiation emitted,  $e$  is the unit charge, and  $c$  is the velocity of light. The factor  $2/3$  is a geometrical factor of a Hertzian dipole. For a single electron oscillating in the dipole ( $N=1$ ) equation (3.1) obtains the form

$$E_{\lambda(0)} = \mathcal{A} (2\pi^3 e^2 \mu_0 c) f \quad (3.2)$$

where  $\mathcal{A} = (2/3)(\xi_0/\lambda)^2$  is the geometrical constant characteristic to the dipole. The factor  $(2\pi^3 e^2 \mu_0 c)$  has the dimension of the Planck constant, and a numerical value of  $5.997 \cdot 10^{-34}$  [kgm/s<sup>2</sup>], and assuming a geometrical constant  $\mathcal{A} = 1.1049$  results in Planck’s equation

$$E_{\lambda(0)} = (1.1049 \cdot 2\pi^3 e^2 \mu_0 c) f = h f \quad (3.3)$$

Equation (3.3) means that a one-wavelength dipole characterized by geometrical constant  $\mathcal{A} = 1.1049$  emits energy  $E = hf$  into one cycle of radiation. The Planck constant can be expressed in terms of the unit charge  $e$ , and the magnetic constant  $\mu_0$  as

$$h = 1.1049 \cdot 2\pi^3 e^2 \mu_0 c \quad (3.3)$$

which shows that the velocity of light,  $c$ , appears as a hidden factor in the Planck constant. By removing the hidden factor, we end with the “intrinsic Planck constant”  $h_0 = h/c$ , which converts Planck’s equation into the form

$$E = h_0 \cdot c \cdot f = \frac{h_0}{\lambda} \cdot c^2 = m_{\lambda(0)} \cdot c^2 \quad (3.4)$$

where the quantity  $h_0/\lambda$  has the dimension of mass [kg]. The quantity  $m_{\lambda(0)} = h_0/\lambda$ , defined by equation (3.4), describes the mass equivalence of a cycle of radiation with wavelength  $\lambda$  produced by a single oscillation of an electron in the emitting dipole.

The energy of a cycle of radiation in equation (3.4) is formally equivalent to the rest energy mass  $m_\lambda$ ,  $E = h_0/\lambda \cdot c^2 = m_\lambda c^2$ , where the wavelength corresponding to mass  $m_\lambda$  is the Compton wavelength,  $\lambda_{Compton} = h_0/m_\lambda$ .

#### *Intrinsic Planck constant and the fine structure constant*

The intrinsic Planck constant  $h_0 = h/c$  has the dimension of mass  $\times$  distance [kg·m] which means that it links the wavelength  $\lambda$  and wave number  $k=2\pi/\lambda$  to the mass carried by a cycle of radiation or the *mass equivalent*

$$m_\lambda = N^2 \frac{h_0}{\lambda} \quad \text{or} \quad m_\lambda = N^2 \hbar_0 k \quad (3.5)$$

where  $\hbar_0 = h_0/2\pi$  is the reduced intrinsic Planck constant. The square of the number of oscillating electrons,  $N^2$ , appears as an intensity factor that for atomic quantum emitters is equal to 1. The mass equivalence of a cycle of radiation is equal to the mass density of electromagnetic radiation,  $m = E/c^2$ , which was deduced by Henry Poincaré from Maxwell's and Poynting's equations in 1900.

Expression of the Planck constant in terms of primary electrical constants reduces the *fine structure constant*  $\alpha$ , originally found by Arnold Sommerfeld, into a purely numerical factor, independent of any physical constants

$$\alpha \equiv \frac{e^2 \mu_0 c}{2h} = \frac{e^2 \mu_0}{2h_0} = \frac{e^2 \mu_0}{2 \cdot 1.1049 \cdot 2\pi^3 e^2 \mu_0} = \frac{1}{1.1049 \cdot 4\pi^3} \simeq \frac{1}{137.0360} \quad (3.6)$$

#### *Unified expression of energy*

The intrinsic Planck constant and the related mass equivalence of electromagnetic radiation allow a unified expression of the energy of a mass particle and of radiation

$$\text{The rest energy of mass } m: \quad E_m = \frac{h_0}{\lambda_m} c^2 = mc^2 = \hbar_0 k_m c^2 \quad (3.7)$$

$$\text{The energy of a cycle of radiation:} \quad E_\lambda = \frac{h_0}{\lambda} c^2 = m_\lambda c^2 = \hbar_0 k_\lambda c^2 \quad (3.8)$$

$$\text{Coulomb energy:} \quad E_{em(r)} = -\frac{e^2 \mu_0}{4\pi r} c^2 = -a \frac{h_0}{2\pi r} c^2 = -m_r c^2 = -\hbar_0 k_r c^2 \quad (3.9)$$

where  $k = 2\pi/\lambda$  is the wave number corresponding to the wavelength  $\lambda$ . The cycle of radiation in (3.8) is the elementary cycle emitted by a single electron transition in

an emitter. In the case on  $N$  electrons oscillating in the emitter the energy of a cycle of radiation is increased by an intensity factor  $N^2$ . Equation (3.9) describes the energy of a unit charge at distance  $r$  from a unit charge of opposite polarity.

The close connection between mass and wavelength illustrates the wave nature of mass and the close connection between the rest energy of mass and electromagnetic energy.

*“Normalizing” the Planck constant into the intrinsic Planck constant expresses the connection between mass and wavelength. The interpretation of Planck’s equation as a property of the emission phenomenon has a major impact on the interpretation of “quantum reality” and the derivation of cosmological predictions.*

#### *The quantum emitter and blackbody radiation*

The connection between Planck’s equation and Maxwell’s equations means that the minimum dose of electromagnetic radiation, a quantum, is one cycle of radiation. The minimum energy in a cycle is obtained by a single electron oscillation in the emitter, which is exactly the energy described by Planck’s equation. The energy emitted by an antenna in a cycle of radiation is

$$E = \mathcal{A} \cdot N^2 \frac{h_0}{\lambda} \cdot c^2 \quad (3.10)$$

where  $\mathcal{A}$  is the geometrical factor characterizing the antenna and  $N$  is the number of electrons oscillating in the antenna. As indicated by equation (3.3), the geometrical factor of a *quantum emitter* is 1.1049, which means that the effective length of the dipole describing a quantum emitter is of the order of one wavelength.

*How can a hydrogen atom, with the diameter less than a nanometer, appear as a quantum emitter or one wavelength dipole when emitting 21 cm microwave radiation?*

In 1900, when Max Planck introduced his equation, there was no answer to the question. The solution can be found by considering the hydrogen atom as a point source in Minkowskian spacetime, where the line element in the fourth dimension, perpendicular to the space directions, is  $\Delta s = c \cdot \Delta t$ . It means that during one cycle, a point source in space directions is extended as  $\Delta s = c \cdot T = c \cdot (1/f) = \lambda$  in the fourth dimension. Accordingly, Max Planck’s resonators at the walls of the black body cavity can be described as one wavelength dipoles in the fourth dimension – with all space directions at the normal planes of the dipole. For such a dipole the energy emitted in a cycle of radiation per a single electron oscillation obtains the form of Planck’s equation

$$E = h \cdot f = \frac{h_0}{\lambda} \cdot c^2 \quad (3.11)$$

When interpreted with the “antenna model”, Planck’s equation is the solution of Maxwell’s equations for the emission of electromagnetic radiation. Applying modern antenna theory, the blackbody radiation can be described in terms of an antenna field occupied by single wavelength antennas with the effective area  $\mathcal{A}_i = \lambda^2/4\pi$ . At high wavelengths, the thermal energy of the surface is enough to activate all surface

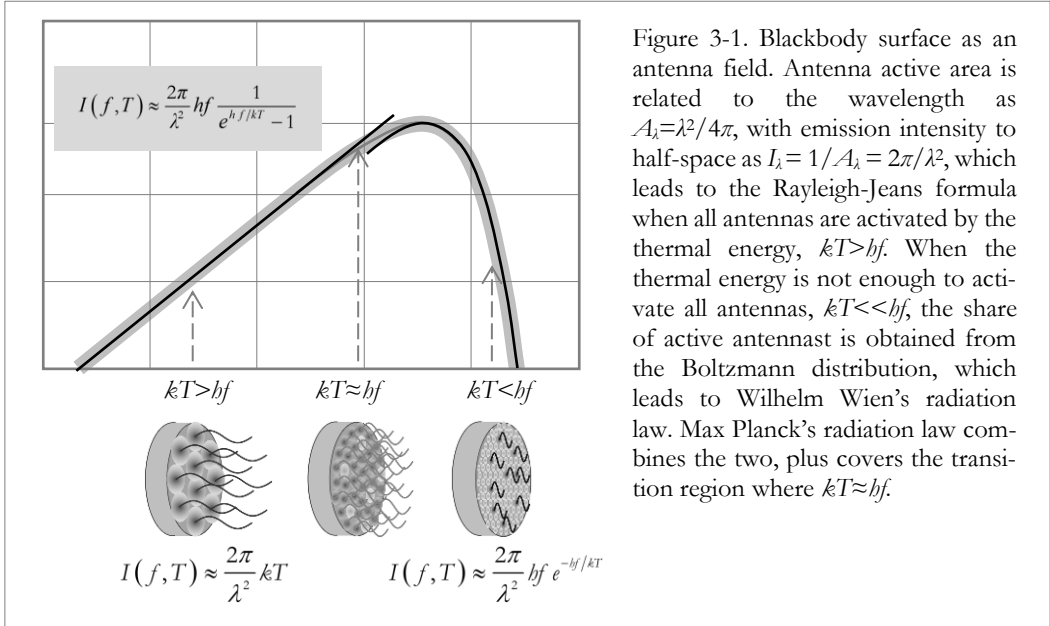

Figure 3-1. Blackbody surface as an antenna field. Antenna active area is related to the wavelength as  $A_i = \lambda^2/4\pi$ , with emission intensity to half-space as  $I_i = 1/A_i = 2\pi/\lambda^2$ , which leads to the Rayleigh-Jeans formula when all antennas are activated by the thermal energy,  $kT > hf$ . When the thermal energy is not enough to activate all antennas,  $kT \ll hf$ , the share of active antennast is obtained from the Boltzmann distribution, which leads to Wilhelm Wien’s radiation law. Max Planck’s radiation law combines the two, plus covers the transition region where  $kT \approx hf$ .

antennas, resulting in Rayleigh-Jeans emission. At short wavelengths, the activation of antennas is restricted by the availability of thermal energy which follows the Boltzmann distribution and we end up to Vilhelm Wiens emission model. Combining the two leads to Max Planck’s radiation law, Figure 3-1.

*The energy described by Planck’s equation is the energy emitted by a single electron oscillation into a cycle of radiation. In principle, a quantum emitter/absorber can be either isotropic or directional. A quantum emitter/absorber is to be understood as a narrow band, wavelength selective antenna in full agreement with Max Planck’s idea of the monochromatic oscillators. Absorption of a quantum of radiation requires that the frequency (or the wavelength) of the incoming radiation corresponds to the characteristic (resonance) frequency of the antenna, and the energy content of the radiation within the capturing area of the antenna is enough to activate one electron transition in the antenna. Explanation of the optoelectronic effect does not require localized photons.*

*The zero-energy balance*

Albert Einstein’s first idea of the cosmological appearance of space described by the general theory of relativity was the three-dimensional “surface” of a four-dimensional sphere. The fourth dimension was the radius of the sphere. Einstein was looking for a static solution; he added the famous cosmological constant to the field equations to prevent a collapse of the 4-sphere by the stress due to gravitation in space.

A dynamic interpretation of spherically closed space can be based on a dynamic balance between the motion of the expanding sphere and the resisting gravitation. Following the dynamic interpretation, the rest energy of all mass in space is balanced by the total gravitational energy of the structure

$$E_{m(tot)} + E_{g(tot)} = 0 \quad \Rightarrow \quad M_{tot}c^2 - \frac{GM_{tot}M''}{R_4} = 0 \quad (3.12)$$

where  $M_{tot} = \Sigma m$  is the total mass in space,  $M''$  the mass equivalence of total mass at the center of the 4D sphere  $M''=0.776 \cdot M_{tot}$ ,  $G$  gravitational constant, and  $R_4$  the 4-radius of space, Figure 3-2.

The volume of the 3D surface of a 4D sphere is  $V=2\pi^2R_4^3$ . Substituting the current estimate of the Hubble radius, 13.7 light years, and the total mass obtained from the present estimate of mass density in space, the total rest energy of mass in space is

$$E_{rest(tot)} \approx M_{tot}c^2 \approx 2 \cdot 10^{70} \quad [J] \quad (3.13)$$

and the total gravitational energy

$$E_{g(tot)} \approx -\frac{GM_{tot}M''}{R_4} \approx -2 \cdot 10^{70} \quad [J] \quad (3.14)$$

Velocity  $c$  can now be solved from the balance of motion and gravitation in the fourth dimension, where  $c$  describes the contraction and expansion velocity of the 4D sphere

$$c \approx \mp \sqrt{\frac{GM_{tot}}{R_4}} \approx 300\,000 \quad [km/s] \quad (= \text{velocity of light}) \quad (3.15)$$

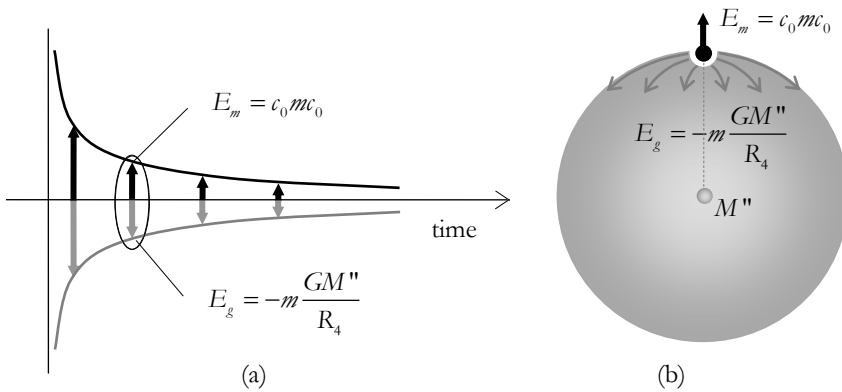

Figure 3-2(a) Zero-energy balance of motion and gravitation. The energy of motion due to the expansion of space in the fourth dimension is observed as the rest energy of mass. The rest energy is counterbalanced by the global gravitational energy due to all mass in space, seen as gravitation arising from mass equivalence  $M''=0.776 \cdot M_{total}$  at the center of the 4D sphere. The expansion of space works against gravitation which results in decelerating expansion. At present, the relative deceleration of the expansion velocity is about  $dc/c \approx 3.4 \cdot 10^{-11}$  /year. The decrease of the expansion velocity also means a reduction of the rest energy. The rates of essentially all physical processes, like the frequencies of atomic clocks, are proportional to the rest energy, which means that the deceleration of the expansion is observable indirectly only.



The zero-energy balance links the maximum velocity in space, and the velocity of light to the expansion velocity in the fourth dimension, and the rest energy to the global gravitational energy. Mass equivalence  $M''$  at the center of space  $M''=0.776 \cdot M_{tot}$  is obtained by integrating the gravitational energy across the spherical surface hosting 3D space.

The approximate equality of the total rest energy and the total gravitational energy in space has been known for several decades. In his lectures on gravitation in the 1960s, the American physicist Richard Feynman stated <sup>103</sup>.

*“If now we compare the total gravitational energy  $E_g = GM^2_{tot}/R$  to the total rest energy of the universe,  $E_{rest} = M_{tot} c^2$ , lo and behold, we get the amazing result that  $GM^2_{tot}/R = M_{tot}c^2$ , so that the total energy of the universe is zero. – It is exciting to think that it costs nothing to create a new particle, since we can create it at the center of the universe where it will have a negative gravitational energy equal to  $M_{tot}c^2$ . – Why this should be so is one of the great mysteries – and therefore one of the important questions of physics. After all, what would be the use of studying physics if the mysteries were not the most important things to investigate”.*

In the lectures he also pondered the possibility of describing space as the 3-surface of a 4-sphere <sup>104</sup>

*“...One intriguing suggestion is that the universe has a structure analogous to that of a spherical surface. If we move in any direction on such a surface, we never meet a boundary or end, yet the surface is bounded and finite. It might be that our three-dimensional space is such a thing, a tridimensional surface of a four sphere. The arrangement and distribution of galaxies in the world that we see would then be something analogous to a distribution of spots on a spherical ball”.*

Obviously, Feynman did not take into consideration the possibility of a dynamic solution to the “great mystery” of the equality of the rest energy and the gravitational energy in space. Such a solution does not work in the framework of the relativity theory which is based on the constant velocity of light, and time as the fourth dimension.

Dynamic space can be compared to a pendulum in spherical symmetry; in the contraction phase, the gravitational potential is actualized into motion, in the expansion phase the energy of motion (the rest energy of matter) obtained in the contraction is paid back to gravitation. In the initial condition, space may be assumed as a homogeneous entity with all mass uniformly distributed into the 3-surface of a 4-sphere. The development of real space can be derived from hypothetical homogeneous space by assuming that the balance of motion and gravitation in the direction of the 4-radius is conserved in the buildup of local mass centers in space. Such an approach shows relativity and the special role of the velocity of light as direct consequences of the conservation of the overall energy balance in space.

The zero-energy situation where the rest energy of any mass object in space is balanced by the gravitational energy arising from the rest of space means a holistic

<sup>103</sup> R. Feynman, W. Morinigo, and W. Wagner, Feynman Lectures on Gravitation (during the academic year 1962-63), Addison-Wesley Publishing Company, p. 10 (1995)

<sup>104</sup> R. Feynman, W. Morinigo, and W. Wagner, Feynman Lectures on Gravitation (during the academic year 1962-63), Addison-Wesley Publishing Company, p. 164 (1995)

picture of reality. Any mass object is associated with gravitational potential extended across the whole spherically closed space.

*The total gravitational potential, as the sum of the gravitational potential due to all mass in space, shall be understood as a scalar field with a specific value at any location in space. A local mass object senses the gravitational potential due to all other mass as gravitational energy and the gradient of the gravitational potential as the gravitational force proportional to its mass.*

### *Motion in space*

Philosophically, relativity can be seen as an indication of the finiteness of resources. According to Newton's mechanics, the velocity of a mass object increases without limits as long as there is a constant force acting on the object. The theory of relativity postulated the velocity of light a limiting velocity. When modified with the time dilation and length contraction of special relativity, Newton's second law of motion shows the mass or momentum of an accelerated object approaching infinity when the velocity approaches the velocity of light. This means that obtaining the velocity of light required an infinite amount of energy.

In DU framework, a similar increase of the momentum of an accelerated mass object occurs without assumptions of time dilation or length contraction. Any mass object in expanding spherically closed space has momentum  $mc$  in the fourth dimension, the direction of the 4-radius of space. Expressing the energy of motion in the fourth dimension as the product of velocity  $c$  and the momentum (like the energy of electromagnetic radiation propagating at velocity  $c$  in space)

$$E_m = c \cdot |\mathbf{p}| = c \cdot mc = mc^2 \quad (3.16)$$

the rest energy appears as the energy of motion due to the expansion of the 4D sphere. Express the fourth dimension as the imaginary dimension perpendicular to all space dimensions, the rest energy obtains the form

$$E_{rest} = E_m = c \cdot imc \quad (3.17)$$

which means that any velocity and momentum in space are associated with orthogonal components due to the expansion of space in the fourth dimension.

Figure 3-3 illustrates the structure of the total momentum as a complex quantity. The real component of the total complex momentum is the momentum observed in space, and the imaginary component is the rest momentum. The scalar value of the total momentum builds up from part  $mc$  equal to the rest momentum at the state of rest, and an additional part  $\Delta mc$  related to the buildup of motion in space

$$|\mathbf{p}_{tot}| = mc + \Delta m \cdot c = (m + \Delta m)c \quad (3.18)$$

Denoting the real component of part  $mc$  of the total momentum as  $mv$  and the real component of part  $\Delta mc$  as  $\Delta mv$ , the momentum  $\mathbf{p}$  observed in space in the direction of the real axis is

$$\mathbf{p} = (m + \Delta m)\mathbf{v} = mv / \sqrt{1 - (v/c)^2} \quad (3.19)$$

and the total energy

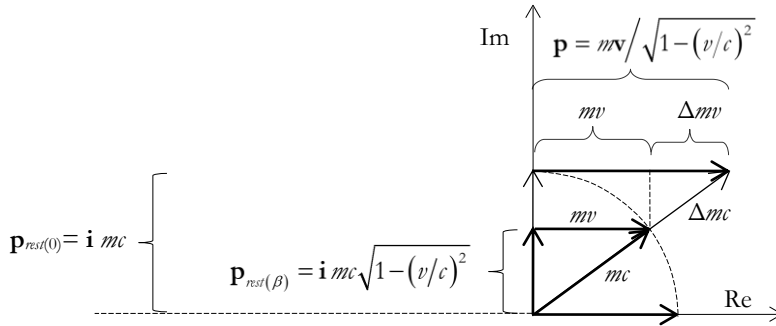

Figure 3-3. A mass object moving at velocity  $\mathbf{v} (= \beta \mathbf{c})$  in space has momentum  $\mathbf{p}$  which is the real component of the total momentum  $p_{tot} = mc + \Delta mc$ . Part  $mv = \text{Re}\{mc\}$  and  $\Delta mv = \text{Re}\{\Delta mc\}$ , i.e., the rotated rest momentum  $mc$  creates momentum  $mv$  as the real component in the direction of velocity  $\mathbf{v}$  in space  $mv$ , which reduces the imaginary component, the rest momentum of the moving object as  $\mathbf{p}_{rest(v)} = i mc \sqrt{1 - (v/c)^2}$ . Momentum  $\Delta mc$  corresponds to energy  $\Delta E = c \cdot \Delta mc$ , which is the kinetic energy obtained from the accelerating system for building up the motion.

$$E_{tot} = c \cdot (m + \Delta m)c = c \cdot mc / \sqrt{1 - (v/c)^2} = c \cdot \sqrt{(mc)^2 + p^2} \tag{3.20}$$

which are equal to the expressions obtained in special relativity applying kinetic analysis with coordinate transformations.

A message of special importance is that the rotation of the rest momentum reduces the imaginary component while releasing momentum  $mv$  to momentum  $\mathbf{p}$  in the direction of the real axis. The reduced imaginary component, the rest momentum of the moving object is

$$\mathbf{p}_{rest(\beta)} = i mc \sqrt{1 - (v/c)^2} \tag{3.21}$$

which can be interpreted as a reduction in the rest mass of the object moving at velocity  $v = \beta c$  in space. A consequence is that the frequency of an atomic oscillator moving at velocity  $v = \beta c$  in space is reduced by factor  $\sqrt{1 - (v/c)^2}$ , which is equal to the reduction, explained as time dilation in special relativity.

Any motion in spherically closed space is central motion relative to the 4-center of space which means creates a central force against the gravitational force in the fourth dimension. The inertial work, the imaginary component of kinetic energy (= the reduction of the rest energy) is the work done against the global gravitational energy due to the rest of space, which means a quantitative explanation of Mach's principle.

*Buildup of local mass centers in space.*

The gravitational energy of a mass object due to all other mass uniformly in all space directions is referred to as the global gravitational energy. Due to the spherical symmetry, the source of the global gravitational energy is observed in the fourth dimension, at the center of the 4-sphere defining space. A local mass center means breaking of the symmetry and the symmetry resulting in a real component to the complex gravitational energy with the global gravitational energy as the imaginary component. Conserving the total energy represented by the imaginary gravitational energy in homogeneous space, the real component,  $E'_g$ , of the total gravitational energy is created via tilting of local space and the associated reduction of the locally observed imaginary gravitation, Figure 3-4.

Tilting of local space and the buildup of a real component to total gravitational energy, means buildup of corresponding real component to the local rest energy,  $E_{m(\psi)}$ . The reduction of the local rest energy is the kinetic energy of mass  $m$  obtained in free fall from homogeneous space to tilted space at distance  $R$  from local mass center  $M$ . The velocity of free fall,  $v_{ff}$ , is obtained against the reduction of the local imaginary velocity, and the local velocity of light in tilted space, Figure 3-5.

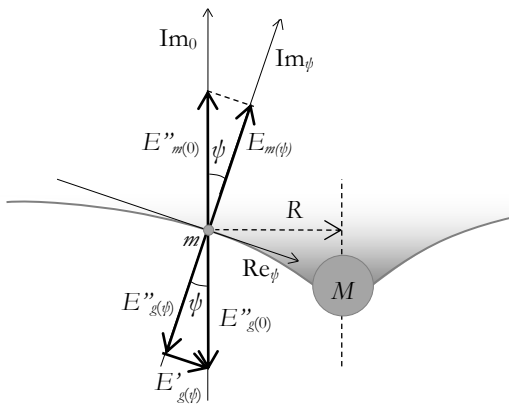

Figure 3-8. Conservation of the energies of motion and gravitation in free fall. In tilted space, the local rest energy and the local imaginary gravitational energy (global gravitational energy) are reduced compared to the corresponding energies in homogeneous space

$$E''_{g(\psi)} = E_{g(0)} \cos \psi = E_{g(0)} (1 - \delta)$$

$$E''_{m(\psi)} = E''_{m(0)} (1 - \delta)$$

where  $\delta = GM/Rc^2$ .

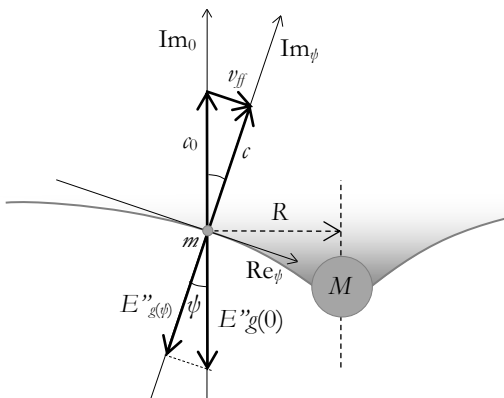

Figure 3-5. Tilting of space in the vicinity of a local mass center turns part of the imaginary velocity of space into the velocity of free fall,  $v_{ff}$ , in space.

The local velocity of light in tilted space is equal to the reduced imaginary velocity,  $c$ , of tilted space.

$$c_\delta = c_0 (1 - \delta).$$

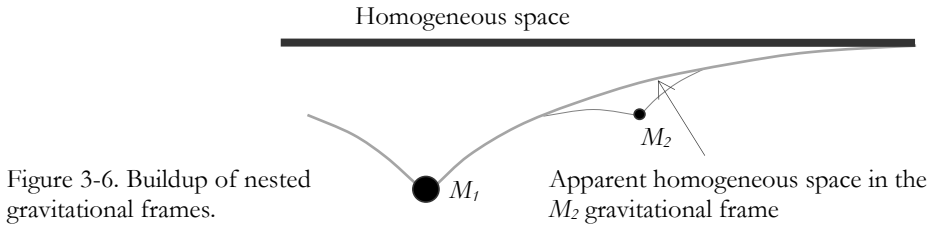

Figure 3-6. Buildup of nested gravitational frames.

*In DU space, local gravitation does not affect the flow of time like in GR space, but it reduces the local velocity light and rest energy which is observed, e.g., as reduced ticking frequency of atomic clocks.*

The buildup of mass centers in space is a stepwise process. In each process, local space is tilted creating a dent relative to its surroundings. Tilted space is associated with a reduction in local velocity of light and rest energy, Figure 3-6.

*The system of nested energy frames*

Figure 3-7 illustrates the system of nested energy frames essential for the energy bookkeeping in space. In real space an object is a member of several systems of gravitation and motion. On the Earth, we reside in the Earth gravitational frame subject to the rotational motion of the Earth. The Earth frame resides in the solar gravitational frame at the gravitational state defined by the orbital radius and the state of motion defined by the orbital velocity. Further, the solar frame moves in the Milky Way frame at the gravitational state determined by the distance to the center of Milky Way, the Milky Way frame in the Local Galaxy Group, etc.

In the general form, the rest energy of mass  $m$  moving at velocity  $\beta_n$  at gravitational state  $\delta_n$  in the  $n$ :th frame is

$$E_m = c_0 m c = c_0 m_0 c_0 \prod_{i=1}^n (1 - \delta_i) \sqrt{1 - \beta_i^2} \tag{3.22}$$

where  $m_0$  and  $c_0$  are the mass and velocity of light in hypothetical homogeneous space. In (3.22) the gravitational factors  $(1 - \delta_i)$  determine the local velocity of light and the velocity factors  $\sqrt{1 - \beta_i^2}$  the rest mass associated with the state of motion

$$c = c_0 \prod_{i=1}^n (1 - \delta_i) \quad \text{and} \quad m = m_0 \prod_{i=1}^n \sqrt{1 - \beta_i^2} \tag{3.23}$$

The frequency of atomic oscillators like atomic clocks is proportional to the rest momentum of the oscillating electrons in the local state. Accordingly, the frequency of atomic clocks is expressed as

$$f_n = f_{(0,0)} \prod_{i=1}^n (1 - \delta_i) \sqrt{1 - \beta_i^2} \tag{3.24}$$

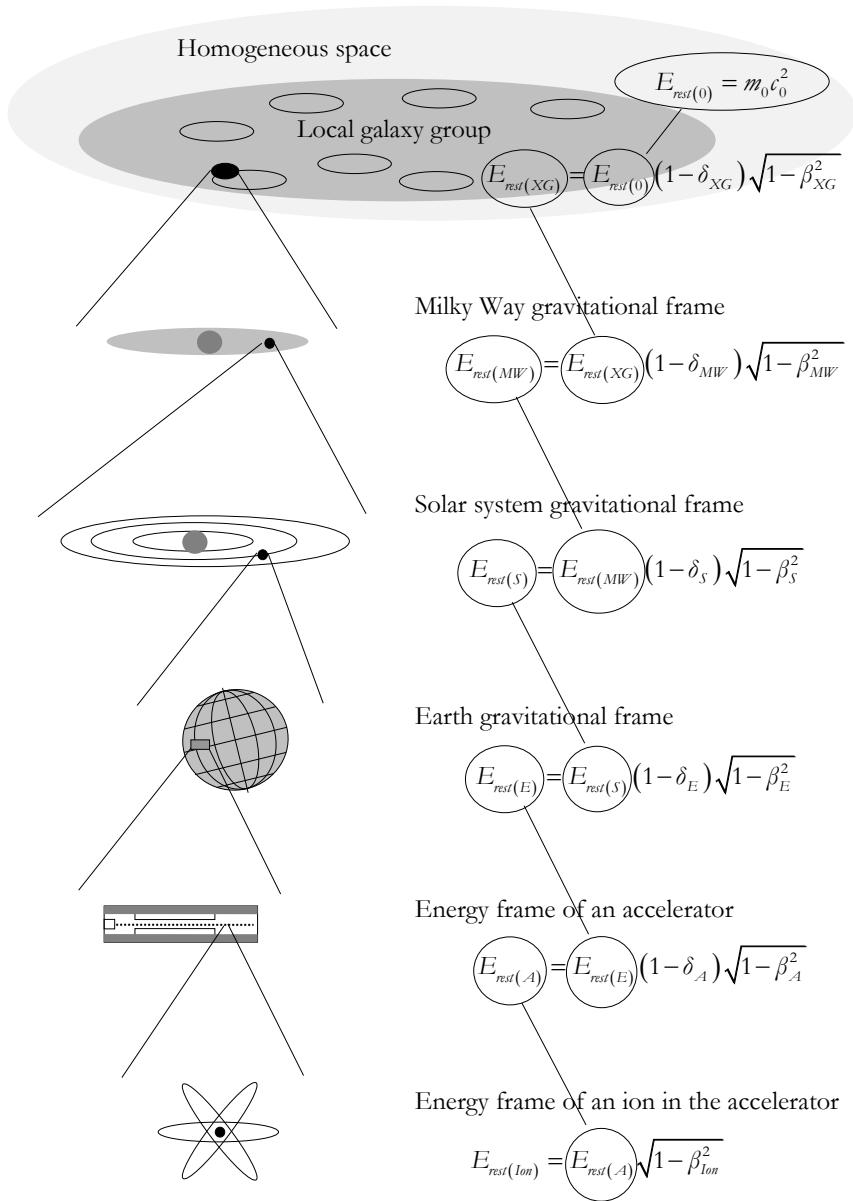

Figure 3-7. The system of nested energy frames. Each energy frame binds its share of the rest energy of an object. The energy state of an accelerated ion is not associated with a change of gravitational state in the accelerator, where the rest energy is affected by the velocity only. The whole accelerator is subject to a velocity and gravitational state in the Earth's gravitational frame, the Earth has its velocity and gravitational state in the Solar system gravitational frame, the Solar system has velocity and gravitational state in the Milky Way frame, the Milky Way in the local galaxy group and the local galaxy group in hypothetical homogeneous space.

In equation (3.24),  $f_{(0,0)}$  is the frequency of the clock at rest in hypothetical homogeneous space. In a local gravitational frame like on the Earth and near space, equation (3.24) reduces into form

$$f_{(\beta,\delta)} = f_{(0\beta,0\delta)} (1-\delta) \sqrt{1-\beta^2} \quad (3.25)$$

where  $f_{(0\beta,0\delta)}$  is the frequency of the clock at rest outside the gravitational interaction with Earth.  $\beta$  and  $\delta$  are the velocity and gravitational state of the clock in the Earth gravitational frame (ECI-frame, Earth Centered Inertial Frame). Equation (3.25) is the DU replacement of the GR solution based on Schwarzschild's solution

$$dt_{(\beta,\delta)} = dt_{(0,0)} \sqrt{1-2\delta-\beta^2} \quad (3.26)$$

On the Earth and in the near space, the predictions given by (3.25) and (3.26) are equal up to the 18:th decimal.

### *Global and local state of rest*

The system of nested energy frames relates any energy state in space to the state of rest in the local frame and all parent frames until to the state of rest in hypothetical homogeneous space. Motion and local gravitation in each frame reduce the rest energy. The reduced rest energy is observed, e.g., as the reduced ticking frequency of atomic clocks.

## **The concept of quantum**

The solution of Planck's equation from Maxwell's equations shows the energy emitted to one cycle of electromagnetic radiation by a single elementary charge oscillation. In radio engineer's terms, the minimum "dose" of electromagnetic radiation is an oscillation cycle emitted by a single electron transition in the antenna. The quantum of radiation does not define the distribution of the radiation in space. The distribution is determined by the geometry of the antenna. One-dimensional resonator like a laser emits a narrow beam in a specific space direction.

Any absorber can be described as a receiving antenna like the emitter. An electron transition in the receiver requires that

- 1) *the frequency of the incoming wave is equal the resonant frequency of the antenna*
- 2) *the energy of the wave front within the active area (capturing area) of the antenna is enough to result the transition of an electron in the receiver*

This means that, e.g., the minimum energy or energy threshold of the photoelectric effect is not a property of the radiation but the property of the receiver (absorber). The selectivity of an antenna is primarily selectivity of the frequency or wavelength of the incoming radiation, and only indirectly selectivity related to the amount of energy.

*Wave description of an energy object*

Applying the wavenumber equivalence of mass,  $m = \hbar k$ , the total energy of motion of a mass object (energy object) can be expressed as

$$E_m^\square = c_0 \hbar_0 k_{\beta} c = c_0 \left( i \hbar_0 k_0 c + \hbar_0 k_{\beta} \beta c \right) \quad (3.27)$$

where  $\hbar_0 k_0$  expresses the rest mass of the object at rest in a local frame, and  $\hbar_0 k_{\beta}$  expresses the mass of the object ( $m + \Delta m$ ) in motion. The rest momentum of the moving object is

$$p_{rest(\beta)} = \hbar_0 k_0 c \sqrt{1 - \beta^2} \quad (3.28)$$

In an energy frame fixed to the object, the object is at rest and it can be described as a resonator or standing wave structure created by waves with wave number

$$k_{rest(\beta)} = k_0 \sqrt{1 - \beta^2} \text{ in opposite directions.}$$

When the resonator object moves at velocity  $\beta c$ , the opposite waves are subject to opposite Doppler shifts; in the wave propagating in the direction of motion the wave number is increased and in the opposite wave the wave number is reduced. Superposition of the opposite waves creates a wave propagating in the local frame in parallel with the object. The net momentum of the sum wave is

$$\mathbf{p}'_{(\beta)} = \frac{\hbar_0 k_0 \cdot \beta c}{\sqrt{1 - \beta^2}} \hat{\mathbf{r}} = \frac{m}{\sqrt{1 - \beta^2}} \mathbf{v} = \frac{\beta m}{\sqrt{1 - \beta^2}} \mathbf{c} \quad (3.29)$$

Momentum in equation (3.29) can be recognized as the momentum of a mass object

$m_{eff} = m / \sqrt{1 - \beta^2}$  moving at velocity  $v = \beta c$ , or the momentum of a mass object

$m'_{eff} = \beta m / \sqrt{1 - \beta^2}$  moving at the velocity of light. The latter can be recognized as

the de Broglie wave and the corresponding momentum, Figure 3.8.

The resonator description used for a mass object applies as such to electromagnetic resonators. In the energy frame fixed to the resonator, the resonator is at rest; velocity  $v = \beta c$  of the resonator frame reduces the wavenumber of the resonator by the factor  $\sqrt{1 - \beta^2}$  – just as in the case of a mass wave resonator. Observing that a Michelson–Morley interferometer can be reduced to a resonator, the zero-result of the famous Michelson–Morley experiment becomes directly explained<sup>105</sup>.

The sum wave carrying the momentum of the resonator in the local frame is responsible for the observed wave-nature of a mass object in the double-slit experiment, Figure 3-9. The internal wave number of the resonator  $k_{\beta(rest)}$  is related to the reduced rest momentum of the object moving in the local frame.

<sup>105</sup> A. Brillat and J.L. Hall, Phys. Rev. Lett. **42**, 9 (1979) 549



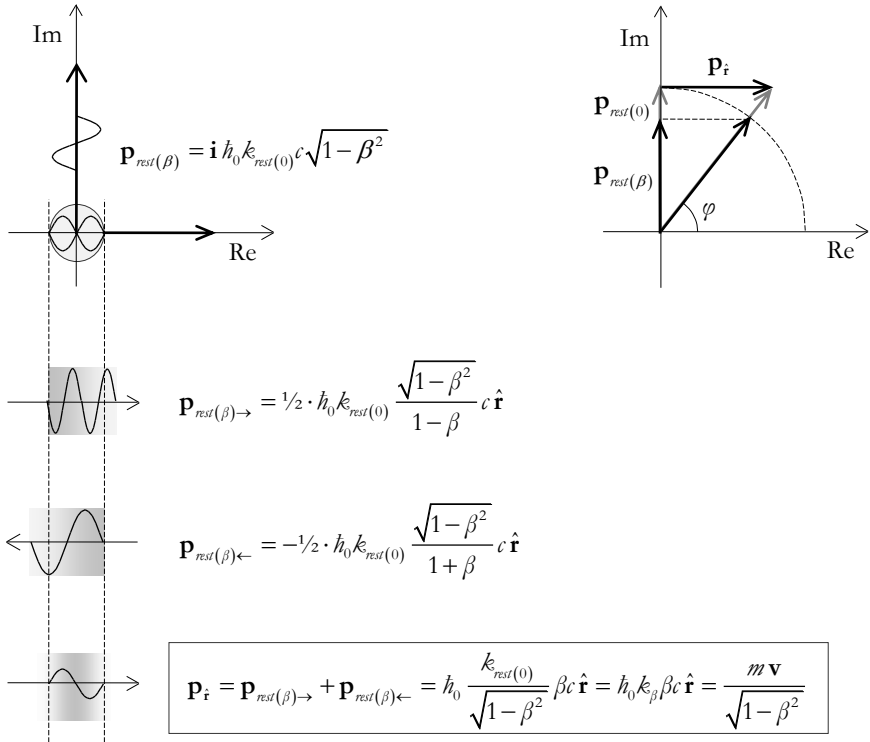

Figure 3-8. A mass object can be described in terms of a resonator with Compton wave number  $k_{rest(\beta)}$ . When the resonator moves at velocity  $\beta c$  in space direction  $\mathbf{r}$ , the wave number of the wave in the direction of the motion, when observed in the rest frame, is increased and the wave number of the opposite wave is decreased due to the Doppler-effect. The superposition of the Doppler-shifted waves is a wave propagating in parallel with the object. The sum wave of the two waves has momentum  $\mathbf{p}'_{(\beta)}$ , which is a wave presentation of the momentum of the object.

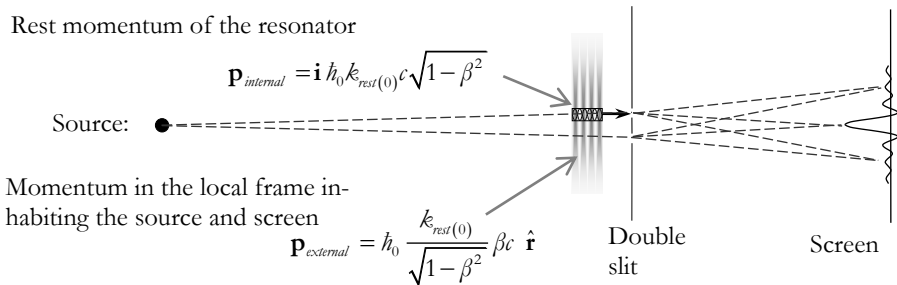

Figure 3-9 A resonant mass wave object in the double slit experiment. The momentum wave propagating in parallel with the object passes each slit independent of the object (resonator) itself. The interference pattern due to the momentum wave is observed at the screen.

*Hydrogen atom*

The energy of an electron, as the sum of the Coulomb energy and kinetic energy of a resonant mass wave around the nucleus, can be expressed as

$$E_n = E_{kin} + E_{Coulomb} = c_0 \hbar_0 k_m c \left[ \sqrt{1 + (n/k_m r)^2} - 1 - Za/k_m r \right] \tag{3.30}$$

where the momentum of the electron mass wave is  $\hbar_0 c \cdot (r/n)$ . The Coulomb energy in the equation is expressed in terms of the intrinsic Planck constant  $\hbar_0$  and the fine structure constant  $a$ . Figure 3-8 illustrates the resonant mass wave and the energies given by equation (4.4) as functions of the orbital radius and the principal quantum number  $n$ . The energy of the electron obtains its minima at

$$E_{z,n} = -c_0 mc \left[ 1 - \sqrt{1 - (Za/n)^2} \right] \approx -(Z/n)^2 a^2 / 2 \cdot mc^2 \tag{3.31}$$

which are equivalent to the relativistic solutions of the principal states in the framework of quantum mechanics. For obtaining the fine structure states the mass wave shall be expressed in a spherical coordinate system for solving the spherical harmonics.

As illustrated in Figure 3-10, the energy states for each value of  $n$  are continuous functions of the radius  $r$ . The “quantum states” are energy minima of energy states fulfilling the resonance condition.

The solution presented is related to Bohr’s and especially to Sommerfeld’s solutions in the “old quantum mechanics” approach. An essential difference, however, comes from the concepts of the mass wave and the intrinsic Planck constant; an electron is described as a mass wave around the nucleus instead of the classical electron particle used in the semi-classical solutions.

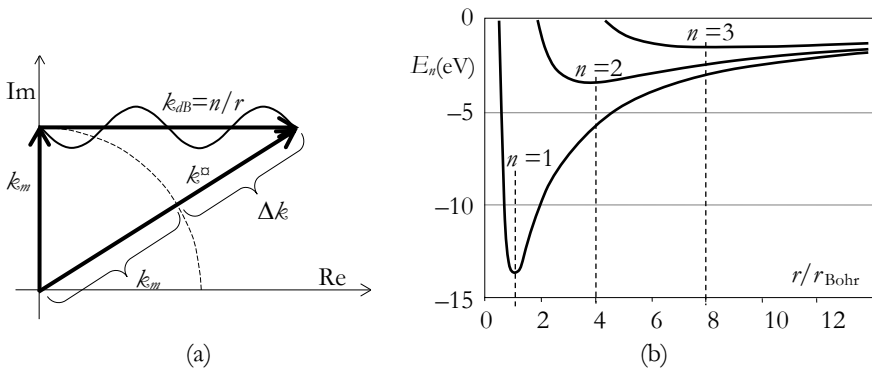

Figure 3-10. Principal energy states of electrons in the hydrogen atom solved on resonant electron mass wave hypothesis. (a) Resonance condition of the real component of the complex mass wave. (b) Total energies given by equation (3.30) for  $n = 1, 2, 3$ . The most probable energy of the electron for each value of  $n$  is the energy minimum of the state (3.31) which energies are exactly those given by quantum mechanics.

## Observations and the picture of reality

### Buildup of energy in Dynamic Universe

The equality of the total rest energy of mass and the estimated gravitational energy in space has been known for several decades but the message of the equality is not solvable in the framework of general relativity. In Dynamic Universe, the equality of the energies of gravitation and motion follows from the primary energy buildup in space; the actualization of the gravitational energy into the rest energy of mass in the contraction-expansion process of spherically closed space. Such a process respects the zero-energy principle and shows Aristotle's *entelecheia*, the actualization of potentiality as a primary law of nature. In the contraction phase, the structure releases gravitational energy into the energy of motion observed as the rest energy of mass for observers in space. The rest energy is "loan" from the gravitational energy. It is paid back to the gravitational energy in the ongoing expansion phase, Figure 3-11.

Mass in DU appears as the substance for the expression of energy; mass expresses energy through motion or gravitation. The development of the energization of mass starts from zero in the past and ends up to zero in the future – possibly subject to a repeated contraction – expansion process.

DU links the expression of energy in space to the dynamics of space as the whole and relates any local motion in space the motion of space. Relativity in DU space is primarily relativity between local and the whole. Relativity is a direct consequence of the finiteness of total energy; it is expressed in terms of the energy available in a local state of motion and gravitation. DU space does not need the relativity principle or coordinate transformations necessary in the theory of relativity.

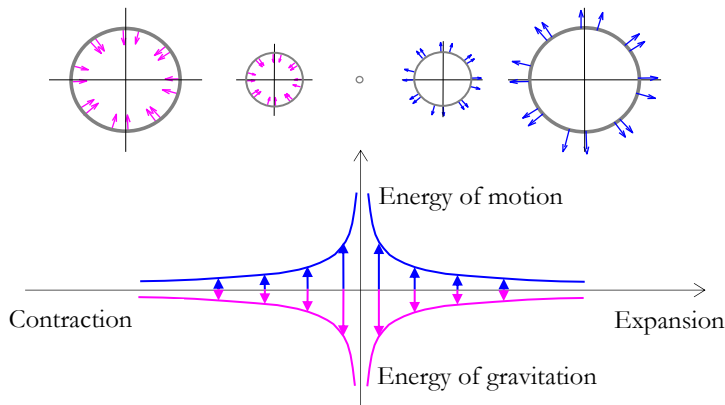

Figure 3-11. The buildup of the rest energy of mass against the release of gravitational energy in the contraction phase, and the release of the rest energy back to gravitational energy in the expansion phase.

The local energies of motion and gravitation in space originate from the primary energy (rest energy) obtained in the contraction-expansion process; any local motion or gravitational interaction in space reduces the locally available rest energy, which is observed, e.g., as reduced ticking frequencies of atomic clocks in local motion or gravitational interaction.

All gravitationally bound local systems like galaxies and planetary systems expand in direct proportion to the expansion of space. Atoms, molecules, and systems bound with electromagnetic interaction do not expand with the expansion of space.

### *The future of space*

Present Big Bang theory describes the birth of the universe as an instant event; it does not predict the future destiny of space. In the current cosmology model, the development of the expansion is linked to the mass density of space and the share of the dark energy added to the theory at the beginning of the century. Dark energy is interpreted as resulting in accelerating expansion towards infinity.

DU-space expands at decelerating velocity due to the work expansion does against gravitation. DU does not have a prediction for possible repeated contraction-expansion cycles which meant cycling universe.

### **Expanding and non-expanding objects and systems**

In Big Bang cosmology, gravitationally bound local systems like galaxies, quasars, and planetary systems do not expand with the expansion of space, as proposed by Willem de Sitter in the early 1930s. De Sitter's conclusions stayed as a part of the Big Bang cosmology. Also, the sizes of atoms and solid celestial objects conserve their dimensions. The wavelength of electromagnetic radiation propagating in space expands in direct proportion to the expansion of space resulting in redshift of radiation received from distant objects. In Big bang cosmology, the expansion of space is described as "Hubble flow" between galaxies and galaxy groups.

In DU-space, gravitationally bound local systems expand in direct proportion to the expansion of space. Atoms and solid objects do not expand. Like in the Big Bang cosmology, the wavelength of electromagnetic radiation propagating in space expands in direct proportion to the expansion of space, Figure 3-12.

The expansion of local systems is a direct consequence of the conservation of total energy in space. The Earth and all planets recede from the Sun. In DU, everything is interconnected. When the Earth is closest to the Sun in January, Moon recedes from the Earth; in the vicinity of the Earth, the velocity of light decreases – so does also the frequencies of atomic clocks. In the laser measurement of the Earth to Moon distance, all these factors are counterbalanced, and the observed distance looks unchanged.

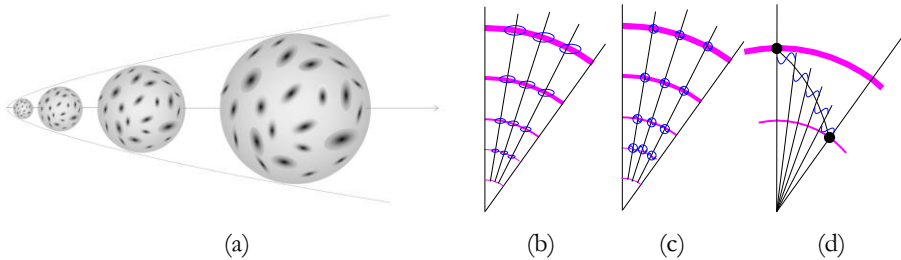

Figure 3-12. (a) Space as the 3D surface of expanding 4D sphere. (b) Gravitationally bound systems, like galaxies and planetary systems, expand in direct proportion to the expansion of space. (c) atoms and solid mass objects do not expand. (d) The wavelength of electromagnetic radiation propagating in space expands in direct proportion to the expansion of space.

### Development of the length of a day and a year

#### *The number of days in a year*

The development of the number of days in a year has been traced from solar eclipse observations up to three thousand years back, from coral fossils for almost 1 billion years back. According to the present theory, the solar system does not expand which means that the length of a year is unchanged. The rotation of the Earth is decelerated by the tidal interaction with Moon and the Sun, which means that the number of days in a year decreases.

Solar eclipse observations recorded in Babylon and China have survived since three thousand years back<sup>106,107</sup>. The increase of the length of day calculated from the observations is about 1.9 ms/100 years. The development of the number of days has been observed from coral fossils almost 1000 million years back, Figure 3-13. When taking into account the increase of the length of a year predicted by DU, the present lengthening of a day calculated from the coral fossil observations is about the same 1.9 ms/100 years as that calculated from the solar eclipses.

According to present theories, the lengthening of the day comes only from tidal friction which gives an estimate of 2.5 ms/100y. The lengthening of a day has been measured with atomic clocks since the 1950s. An announced value is 1.5 ms/100y. When the DU based decrease of the frequency of atomic clocks, 0.3 ms/100y is added, the result comes close to the 1.9 ms/100y matching with the eclipse and coral data.

In DU, the planetary system expands with the expansion of space which increases the Earth to Sun distance resulting in an increased length of the year. Combining all DU factors, an excellent match with observations is obtained, Figure 3-13.

<sup>106</sup> Stephenson, F. R.; Morrison, L. V., *Philosophical Transactions: Physical Sciences and Engineering*, Volume 351, Issue 1695, pp. 165-202 (1995)

<sup>107</sup> F. R. Stephenson, L. V. Morrison, C. Y. Hohenkerk, *Measurement of the Earth's rotation: 720 BC to AD 2015*, Proceedings of the Royal Society A, 7 December 2016. DOI: 10.1098/rspa.2016.0404, <http://rspa.royalsocietypublishing.org/content/472/2196/20160404>

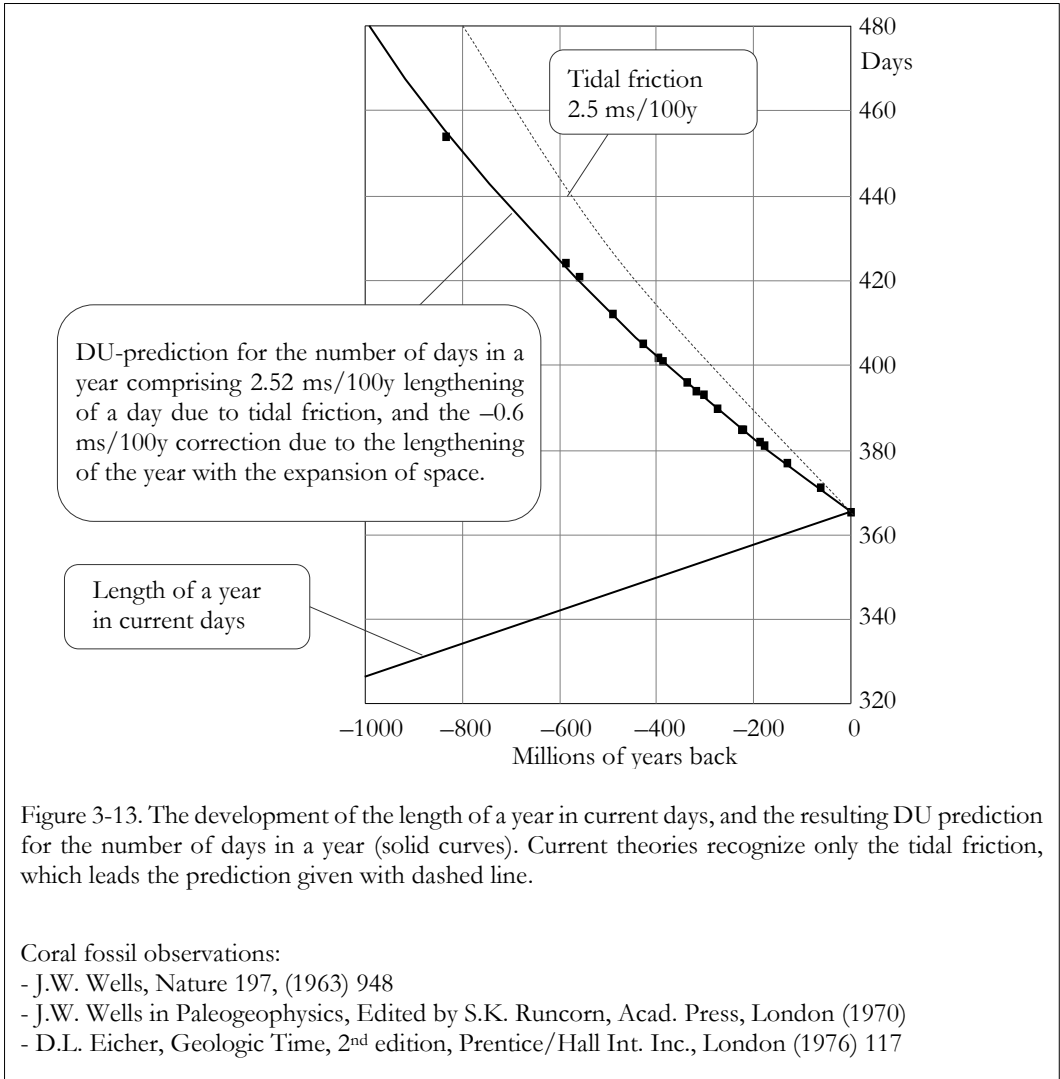

### *Earth to Moon Distance*

According to the theory of relativity, the expansion of space does not affect the Earth to Moon distance. No annual fluctuation is predicted due to the eccentricity of Earth's orbit.

The Earth to Moon distance has been measured since the 1970s with high accuracy in the Laser Ranging Program<sup>108</sup>. The measurement is based on the two-way transmission time of a light pulse from the Earth to a reflector on the Moon and back to the Earth. Based on the measurement data, the Earth to Moon distance increases by 3.8 cm/year. Based on current theories, the increase is solely due to tidal interactions.

<sup>108</sup> J.O. Dickey, et.al. Science 265 (1994) 482

In DU, the orbital radius of Moon is subject to increase in direct proportion to the expansion of space which results in 2.8 cm annual increase in the Earth to Moon distance. Accordingly, only 1 cm of the measured annual increase is due to Tidal interactions. An effect of special interest comes from the eccentricity of Earth's orbit around the Sun. At the perihelion point, the Earth to Moon distance is at its maximum; the orbital velocity of the Earth is at its maximum, and the gravitational potential due to Sun is at the minimum. The last two factors decrease the frequency of the clocks used in the measurement, and the last factor decreases the velocity of light in the vicinity of the Earth. Putting all these factors together, the actual increase of the Earth to Moon distance is undetectable in the laser measurement as confirmed by the observations.

### Observations of distant space

#### *Propagation of light in expanding space*

Spherically closed space can be characterized as curved three-dimensional space with the radius of curvature in the fourth dimension. In DU, the fourth dimension is not time – time is a universal scalar quantity required by the concept of velocity. Universal time allows the study of dynamics equally in the three space dimensions and the fourth dimension and serves as the measure in common for velocities, frequencies, and the rates of physical processes in general. The expansion of spherically closed space means velocity in the fourth dimension; distance  $dR_4 = c_0 dt$  is the distance space expands in time differential  $dt$  in the direction of the 4-radius  $R_4$ .

The size and expansion velocity of space are determined by the dynamics of space. In terms of dynamics, space is the “zero-energy surface”, contracting and expanding in the four-dimensional universe.

The momentum and energy of motion related to the contraction and expansion are observed as the rest momentum and energy in space. Electromagnetic radiation propagates in space directions perpendicular to the fourth dimension. The propagation velocity is determined by the velocity of space in the local fourth dimension. The momentum of radiation appears in the direction of propagation only – the expansion of space gives radiation a “free ride” or displacement in the fourth dimension.

In DU space, cosmological objects are observed in apparent Euclidean space, although the propagation path of light follows the expanding curved 3D space, Figure 3-14.

Light propagates in space at the same velocity as space expands in the radial direction. The observed velocity of light in space is the velocity of energy transport. The optical distance of the object is the distance light propagates in the space direction. Because the velocity of light in space (in the tangential distance) is equal to expansion velocity of space in the radial direction, the optical distance is equal to the increase of the 4-radius during the propagation time, Figure 3-16.

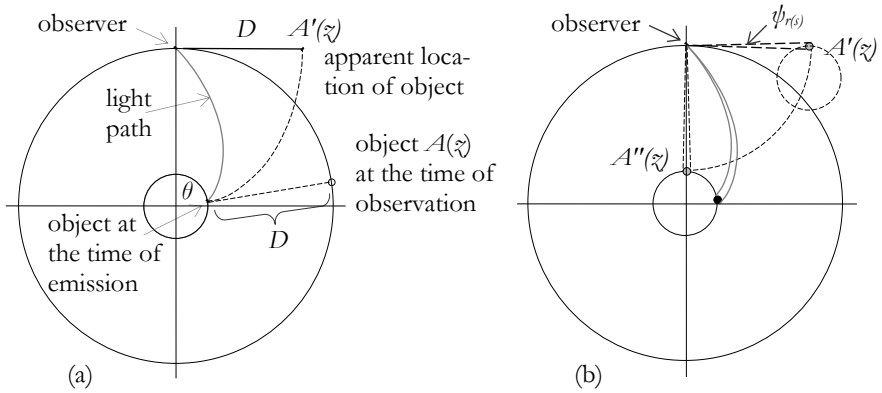

Figure 3-14. (a) Proagation of light in spherically closed space. Circles in the the pictures illustrate a selected space direction, radius is in the fourth dimension. Light propagates in curved space along the circle. Distance to the apparent location of the object  $A'(\vec{z})$  is the optiual distance  $D = R_{(observation)} - R_{(emission)}$ , the tangential component of the 4D path. (b) The angular size  $\psi_{r(s)}$  of the object in the apparent location  $A'(\vec{z})$  is equal to the angular size of the object in hypothetical location  $A''(\vec{z})$  at distance  $D$  in the direction of radius  $R_4$ .

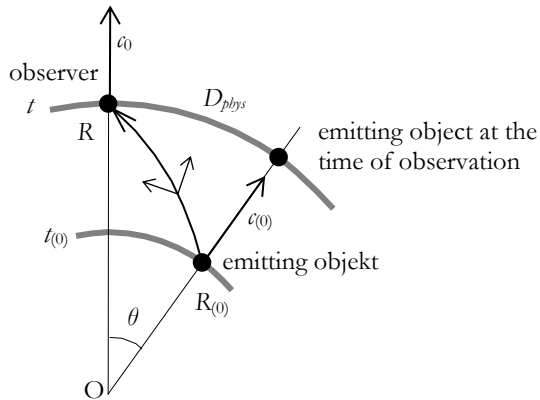

Figure 3-15. The buildup of optical and physical distances in spherically closed space. Physical distance means the distance of the object at the time of observation. For observations, the most important distance is the optical distance, which is the integrated length of the tangential component of the propagation path. Because the velocity of light in space (in the tangential distance) is equal to expansion velocity of space in the radial direction, the optical distance is equal to the increase of the 4-radius during the propagation time.



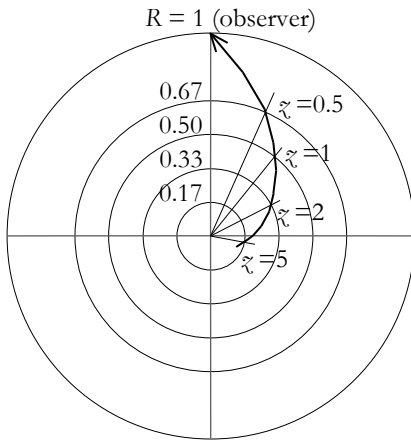

Figure 3-16. The length of the  $R_0$  radius and the location of objects for redshifts  $z = 0$  to 5. Location  $R_4 = 1$  is the observer's location. The optical distance to the object is the tangential length of the path, which is equal to the difference between the current  $R_4$  radius and the  $R_{4(0)}$  radius as it was when the light was emitted. For example, the light emitted at  $R_4 = 0.17$  in the drawing is redshifted by  $z = 5$  after traveling the distance  $D = (1-0.17)R_0$  in expanding space.

*Angular diameter and brightness*

For non-expanding objects, like solid stars, the angular diameter is obtained from the optical distance as

$$\psi_{r(z)} = \frac{d}{D} = \frac{d}{R_0} \frac{z+1}{z} \tag{3.21}$$

All gravitationally bound local systems like galaxies and planetary systems expand (unlike in standard cosmology) in direct proportion to the expansion of space resulting in the angular diameter

$$\psi_{r(z)} = \frac{d_R / (1+z)}{D} = \frac{d_R}{R_0} \frac{1}{z} \tag{3.22}$$

where  $d_R$  is the diameter of the object at the time of observation. Equation (3.22) means, that space with expanding object is seen in Euclidean geometry, i.e., the diameter of the objects is observed in inverse proportion to the distance.

Current FLRW cosmology predicts that in near space ( $z < 1$ ) the angular diameter of the quasars and galaxies decrease like in Euclidean space but turn in an increase for distant objects with redshift  $z > 10$ , Figure 3-17(a).

The increase of the predicted angular diameter is concluded from special relativity, which requires that the angular size is conserved, maintaining the value it had at the time of the emission. The prediction is also affected by the non-expanding nature of the objects assumed in FLRW cosmology.

As seen in Figure 3-17, observations do not support the increasing angular diameter predicted by FLRW cosmology. The effect of dark energy on the prediction is small. The Euclidean DU prediction for the angular size of galaxies and quasars corresponds to observations, Figure 3-17(b).

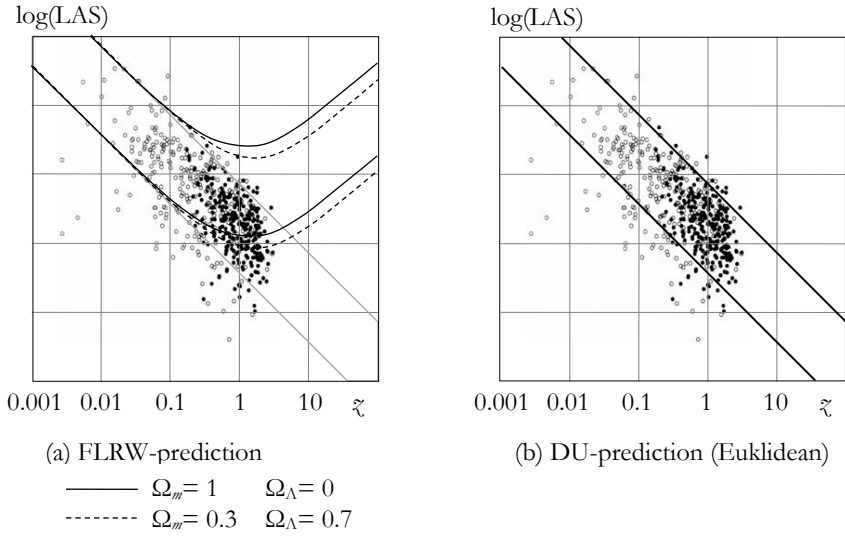

Figure 3-17. Dataset of the observed Largest Angular Size (LAS) of quasars (filled circles) and galaxies (open circles)<sup>109</sup> in the redshift range  $0.001 < z < 3$ . (a) FLRW prediction with two sets of density parameters. As shown by the curves in (b) the density parameters have only a minor effect on the predicted angular sizes. (b) The Euclidean appearance of the DU prediction (3.22) gives an excellent match with observations.

### *Magnitude versus redshift; Supernova observations*

The energy density of radiation decreases in direct proportion to the increase of the wavelength due to the expansion of space and suffers areal dilution that is proportional to the square of the optical distance. The resulting DU prediction for the magnitude of an object with redshift  $z$  is

$$m = M + 5 \log \frac{R_0}{d_0} + 5 \log z - 2.5 \log(1+z) + K \quad (3.23)$$

where  $M$  is the absolute magnitude,  $d_0 = 10$  pc is the reference distance of the absolute magnitude, and  $K$  is  $K$ -correction related to instrumental factors. The DU prediction applies to bolometric magnitudes. In present praxis observed magnitudes are reduced to "emitter's rest frame" by adding term  $5 \log(1+z)$  to the instrumental  $K$ -correction to match with the FLRW prediction. For comparing the DU prediction to  $K$ -corrected magnitudes, the same term shall be added to the instrumental  $K$ -correction in equation (3.23).

Supernova observations at the end of last century and in the early 2000s allowed more precise observations of magnitude versus redshift of standard sources. To match the FLRW prediction to observations, Einstein's cosmological constant, initially proposed for static space, was re-woken as dark energy, Figure 3-18.

<sup>109</sup> K. Nilsson et al., *Astrophys. J.*, 413, 453, (1993)

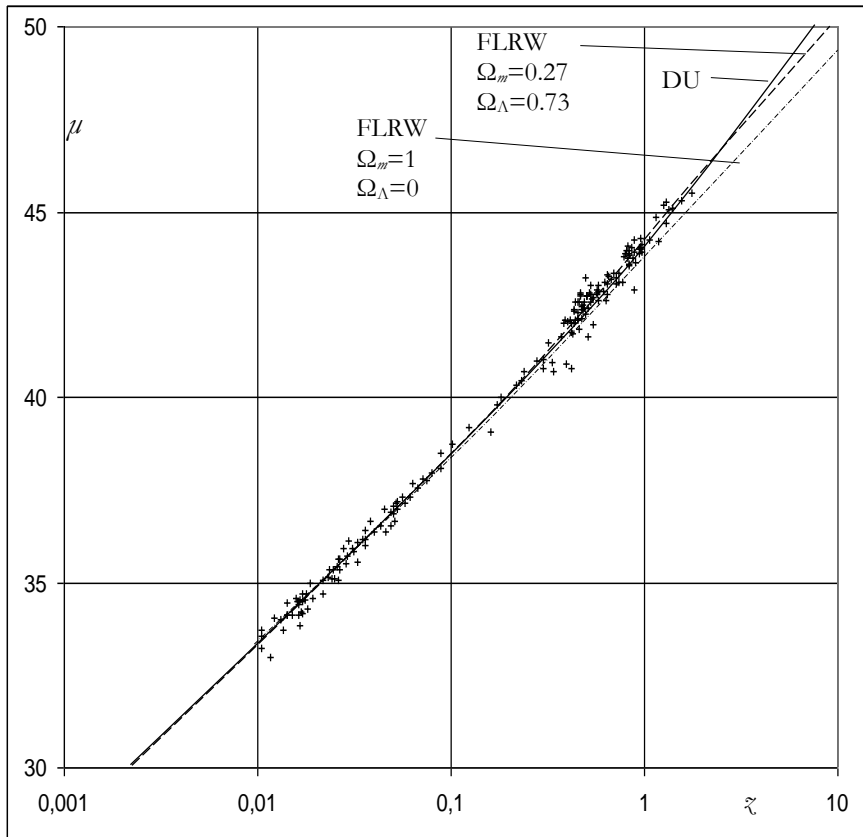

Figure 3-18. Distance modulus  $\mu = m - M$ , vs. redshift for Riess et al. “high-confidence”  $K$ -corrected dataset and the data from the HST, presented on a logarithmic scale. The *FLRW* prediction with original  $\Omega_m=1$  and  $\Omega_\Lambda=0$  parameters is illustrated with a dot-dashed line and the prediction corrected with dark energy,  $\Omega_m=0.27$  and  $\Omega_\Lambda=0.73$ , with a dashed line. The match of the  $\Omega_m=0.27$  and  $\Omega_\Lambda=0.73$  curve in the figure led to the hypothesis of dark energy. The DU prediction given by the solid line does not need dark energy or any other additional parameters but gives the best chi-square value in comparison to the observations.

The magnitude prediction in FLRW cosmology relies on the comoving distance as the bases for the luminosity distance. Comoving distance is higher than the light time distance (closest to the DU optical distance). Further, the FLRW prediction applies both Doppler-dilution and Planck-dilution in the interpretation of the power dilution due to redshift. Such a double dilution means loss of energy during the propagation in expanding space. The oversized areal dilution due to the use of comoving distance and the double dilution due to expansion is compensated with  $K$ -correction used to reduce the bolometric observations to “emitter’s rest frame”.

### Local mass centers in space

The general theory of relativity describes gravitation in terms of the space-time curvature. The curvature is determined by the mass and energy content in space. Mass centers are surrounded by a dent in space-time, mathematically known as Schwarzschild's space.

In DU, the fourth dimension is not time but the direction of the radius of the 4D sphere closing 3D space. The geometry of space around a mass center can be solved assuming conservation total gravitational energy; the resulting solution is closely related to Schwarzschild's space.

In DU, the energy structure of space is described in term of nested energy frames. The dents around the Earth and the planets orbit around the with their central masses in the dent around the Sun, which orbits the center of Milky Way in the dent around the center of Milky Way, Figure 3-19. Local curvature of space reduces the local velocity of light, which is observed, e.g., as reduced ticking frequency of atomic clocks.

Bending of local space near mass centers is a direct consequence of the conservation of total energy in space. The kinetic energy of mass objects in free fall in curved space is built up against the reduction of the rest energy of the falling object. Also, due to the curvature, the velocity of space in the local fourth dimension is reduced, reducing the local velocity of light.

The buildup of dents around mass centers occurs in several steps; the dent around the Sun is built in Milky Way dent, and the dents around planets in the dent around the Sun, the solar gravitational frame.

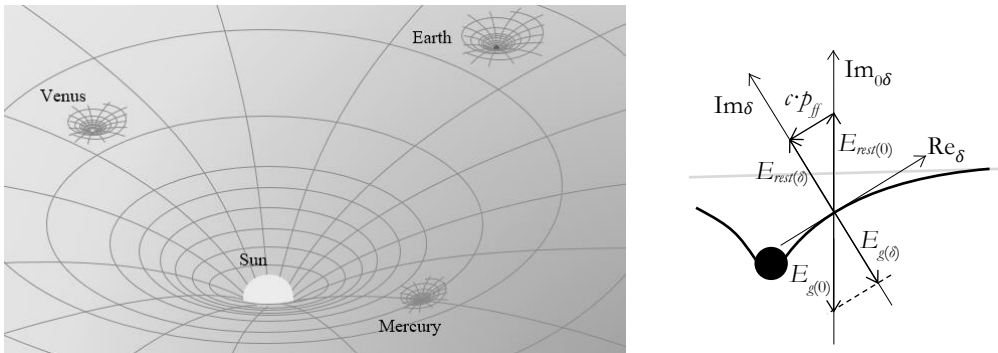

Figure 3-19. The "depth profile" of the solar gravitational frame in the direction of the fourth dimension. Earth is about 26 000 km "higher" than the Sun; Pluto, far from the Sun, not seen in the picture is about 180 000 km higher than the Sun.

*The velocity of light near mass centers*

In the theory of relativity, the velocity of light is constant by definition; instead, near mass centers, the flow of time is reduced due to the curvature of space-time.

In DU, the curvature of space near mass centers reduce the local velocity of light determined by the velocity of space in the local fourth dimension.

The linkage of the velocity of light to the local 4D velocity of space means that the local velocity of light is a function of the local gravitational potential – in practice, a function of the distance and mass of the local mass center. When the Earth orbits the Sun, the potential well follows the orbiting, Figure 3-20(a). Figure 3-20(b) illustrates the velocity of light in the vicinity of the Earth and Moon. In the figure, Moon is behind the Earth when looked from the Sun. The effect of the Sun on the velocity of light is seen as a smooth decrease of the velocity of light towards the Sun.

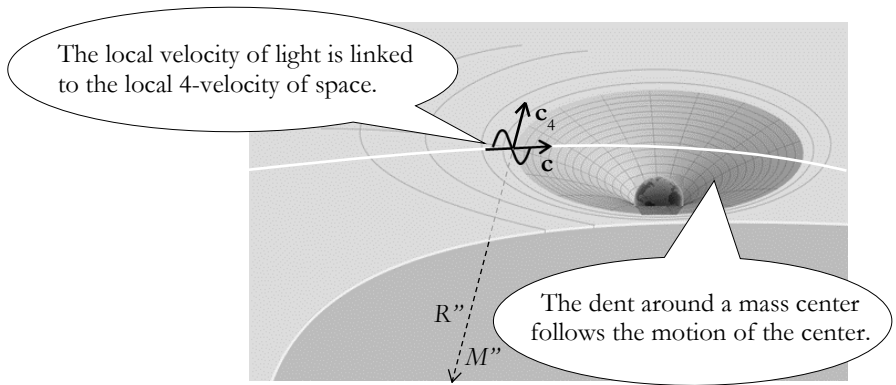
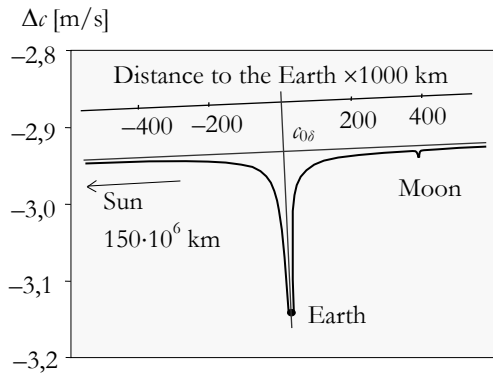

Figure 3-20 (a). Electromagnetic radiation propagating in space is linked to the velocity of space in the local fourth dimension.

Figure 3-20 (b). The reduction of the velocity of light in the vicinity of the Earth and Moon. The reference velocity is the velocity of light far from the Sun. The effect of the Milky Way on the local velocity of light in the solar frame is about  $\Delta c \approx -300$  m/s.



*Michelson-Morley experiment*

One of the most famous and historically important experiments on the velocity of light is the experiment carried out by Albert Michelson and Edward Morley in the late 1880. To determine the effect of the orbital velocity of the Earth on the local velocity of light, they used an interferometer on a rotating table to compare the velocities of light in the direction of Earth's motion and perpendicular to the motion. No interference difference between the light in parallel and perpendicular arms of the interferometer was found, which led to annulling of the world ether theory and the declaration of the constancy of the velocity of light for any observer, at any state of motion.

In DU, the linkage of the velocity of light to the local 4-velocity of space means that the orbital velocity of the Earth does not sum up to the velocity of light thus explaining the M-M experiment.

Later on, the M-M experiment has been repeated with resonators sensible enough to detect a possible effect of Earth's rotation on the velocity of light. The zero results have been obtained in all such experiments, which has been interpreted as a confirmation of the postulated constancy of the velocity of light. In terrestrial experiments, a resonator is subject to the rotational velocity of the Earth; the resonance condition is conserved observed as the conservation of the phase velocity in opposite waves in the resonator. The signal velocity of light is linked to the local gravitational potential which is unaffected by the rotation of the Earth; the signal velocity of light is observed in the Earth gravitational frame (Earth Centered Inertial Frame, ECI-frame).

The linkage of the signal velocity to the ECI frame is observed in communication between satellites and Earth's stations like in the GPS positioning system. The rotation of the Earth increases or decreases the satellite signal transmission distance due to a displacement of the receiver during the transmission. The velocity of light is the corrected transmission signal divided with the transmission time. In the framework of relativity theory, the change in the transmission distance is included as a separate Sagnac-correction. The result is the same in both calculations.

*Bending of light and the Shapiro-delay*

Bending of light was one of the first predictions of general relativity. Confirmation of the prediction in the 1919 solar eclipse meant a breakthrough of the theory. In addition to bending, passing of a mass center results in a delay in the signal propagation time, referred to as Shapiro delay. Shapiro delay has been successfully tested with radar signals to the neighboring planets. A famous experiment was carried out with Mariner 6 and 7 spacecrafts on their way to planet Mars. When the two spacecrafts were behind the Sun relative to the Earth, the radio signal to the Earth passed close to the Sun, at the distance of 3.5 and 5.9 times the radius of the Sun, respectively, Figure 3-21.

In the GR and DU predictions for the Shapiro delay, there is a small (about 10%) difference due to an additional constant term in the DU prediction. The calculated signal delays in the Mariner experiments were delays relative to the hypothetical delay

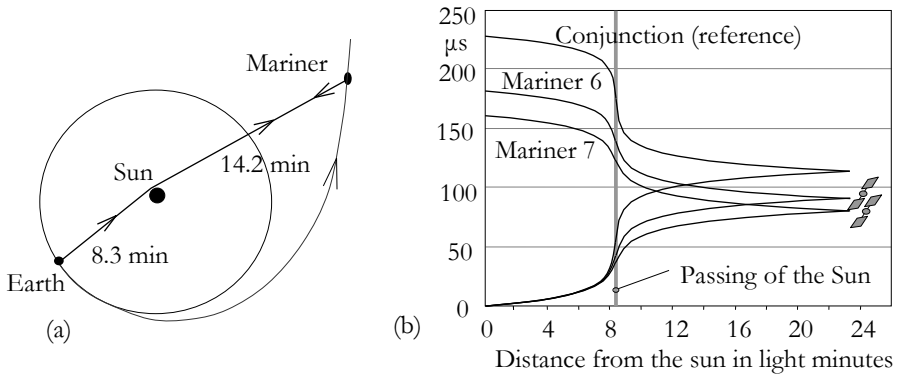

Figure 3-21. (a) Measurement of the delay in a radio signal due to the gravitation of the Sun. (a) The route of the Mariner space crafts from the Eart to Mars and the path of the radio signal to and from Earth. (b) The development of the two-way radio signal passing the Sun in Mariner 6 and Mariner 7 experiments.

in exact conjunction, which eliminates the effect of the constant term and makes the two predictions equal. The difference is in the interpretation of the cause of the delay, GR relies on a slower flow of time near the Sun, and DU relies on a slower velocity of light.

## Celestial mechanics, the perihelion advance

### *Mercury perihelion advance*

An explanation for the 43 arc second/century difference between the observed and predicted perihelion advance of the planet Mercury was a foreseeable prove of general relativity more than a year before the completion of the theory of general relativity.

The GR prediction for the perihelion advance, or main axis rotation, is derived from the Schwarzschild solution of the GR field equations. Typically, the solution is expressed for a single rotation which allows the elimination of a cumulative term showing an increase of the main axis. If the calculation is applied to orbits near the critical radius of a black hole, the cumulative term casts the orbiting object out of the orbit, Figure 3 22 (a). According to the Schwarzschild solution, same occurs in the case of Mercury if the calculation is continued for a couple hundred thousand years when the rotation of the main axis exceeds  $45^\circ$ , Figure 3-22 (c). The DU-solution does not include cumulative terms, which keeps the orbits stable 3-22 (b) and (d).

In Schwarzschild space, not only elliptic orbits but also circular orbits become unstable in the vicinity of black holes; mathematically, the orbital velocity exceeds the escape velocity when the orbital radius is smaller than three times Schwarzschild's critical radius (which is two times the DU critical radius). Three times Schwarzschild's critical radius (which is two times the DU critical radius).

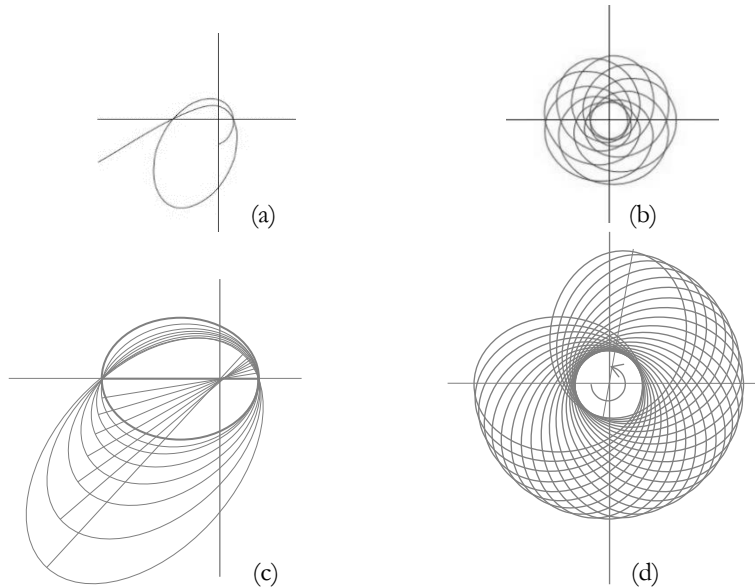

Figure 3-22. The development of elliptic orbits around mass centers. (a) Rotation of the main axis of the orbit around a black hole in Schwarzschild's space and (b) in DU-space. The perihelion advance of Mercury (c) in Schwarzschild's space and (d) in DU-Space. Predictions in Schwarzschild's space (a) and (c), are based on the solution given in M. Berry's book *Principles of Cosmology and Gravitation*, Cambridge University Press, p.83 (1989). The solution is associated with a cumulative term increasing the orbital radius – resulting in the escape of the orbiting object when the rotation exceeded 45 degrees.

### *Orbits near black holes*

In the DU-solution, there is a minimum period when the orbital radius is equal to two times the critical radius. The solution is experimentally supported by observations on 16.8 min periods around Sagittarius A\* in the center of the Milky Way. The DU prediction for the minimum period around Sgr A\* is about 15 minutes which allows the shortest observed periods of 16,8 minutes. Schwarzschild solution does not allow periods under 28 minutes for Sgr A\*, Figure 3-23. Faster periods are explained with Kerr's black holes where space itself rotates speeding up the rotation of the objects.

### *Orbital decay in double stars*

Gravitational radiation has received significant attention after the observations of assumed gravitational radiation by LIGO and VIRGO detectors in 2016. The energy of gravitational radiation is supposed originating from the orbital decay due to quadrupole gravitation and the associated reduction in the rotational period in orbiting systems.



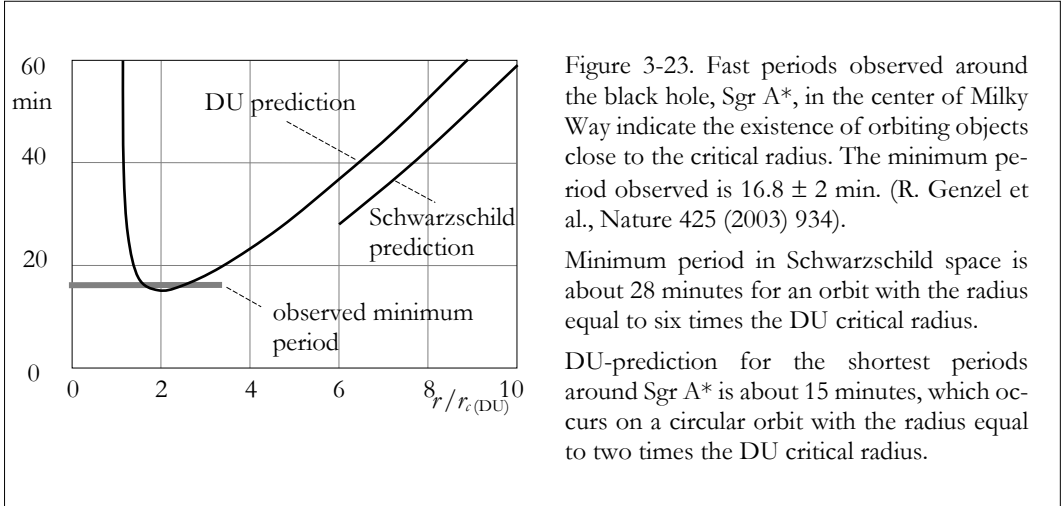

In DU framework, the orbital decay of rotational systems is due to the rotation of the orbital angular momentum related to the rotation or the main axis of elliptic orbits, Figure 3-24 (a).

In spite of the different theoretical bases, the predicted orbital decays in GR and DU frameworks are practically identical; the only difference comes from the effect of eccentricity of the orbits. According to the DU analysis, decay occurs in eccentric orbits only, whereas the GR analysis allows orbital decay in circular orbits, too. The effect of eccentricity on the decay is illustrated in Figure 3-24 (b). The eccentricity factor in the DU prediction approaches zero for zero eccentricity but saturates to value one in the GR prediction. In DU framework, possible gravitational radiation associated with the orbital decay has not been analyzed.

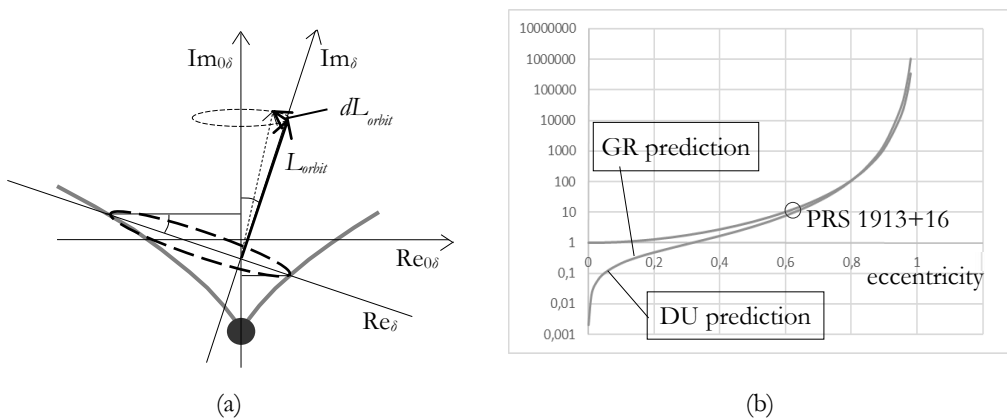
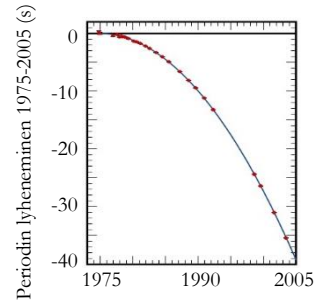

Figure 3-24. (a) The 4D angular momentum  $L_{orbit}$  of an eccentric orbit, in the direction of the  $Im_\delta$  axis of the orbital plane, rotates with the periastron advance of the orbit. The energy of the rotation is counterbalanced by the decay of the orbital period. b) The eccentricity factor of the decay of binary star orbit period. At the eccentricity  $e = 0.616$  of the PSR 1913+16 orbit the eccentricity factor in the GR and DU prediction is essentially the same and lead to the same prediction for the decay, Figure 3-25.

Figure 3-25. Both GR and DU predictions (solid line) for the orbital decay of PSR B1913+16 double pulsar correspond to observations with excellent accuracy. Picture: *Wikimedia Commons*.



The most famous observational evidence of the orbital decay is the work by R. A. Hulsen and J. H. Taylor Jr. on the orbital decay of double pulsar PSR B1913+16. Observations made since 1975 show an excellent match with the GR and DU predictions, Figure 3-25.

### The frequency of atomic clocks on the Earth and in near space

In the framework relativity theory, the velocity of light is constant in all observation frames of reference. In laboratory experiments, the effect of motion on atomic clocks is explained with time dilation of special relativity affecting the test clock in motion relative to observer's clock at rest in observer's frame of reference. As confirmed by the experiments, the rotational or orbital velocity of the Earth does not affect the results, Figure 3-26 (A,B). In terrestrial experiments on gravitational effects on clocks, both the test clock and reference clock are in the same state of motion. The difference in the ticking frequencies between the clocks at different gravitational potential is explained with different flow of time in different gravitational states, Figure 3-26 (C).

In experiments in near space, the velocity of both the test clock and the reference clock in the Earth Centered Inertial (ECI) frame, as well as the gravitational state of each clock, shall be taken into account, Figure 3-26 (D,E,F).

In DU framework, the ticking frequency is based on the quantum mechanical solution of the characteristic frequency, which is proportional to the rest momentum of the oscillating electron. The rest momentum, the product of rest mass and the local velocity of light, is affected by motion via the rest mass, and by gravitation via the local velocity of light.

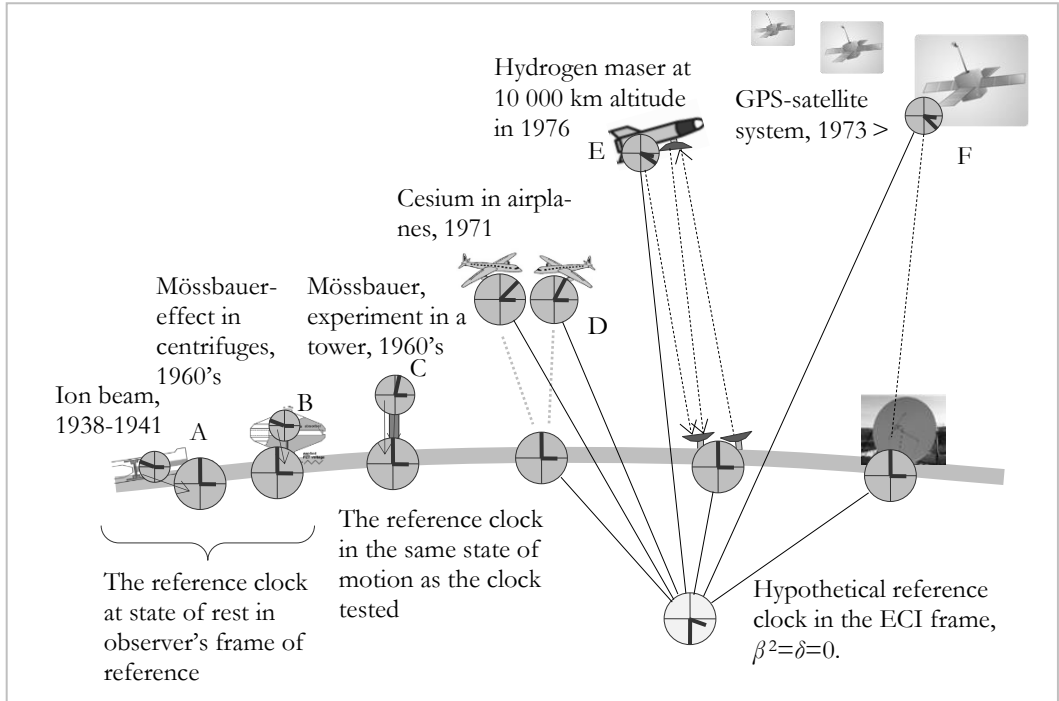

Figure 3-26. Laboratory and near space experiments for testing the effects of motion and gravitation on atomic emitters and clocks.

- A. Experiments with hydrogen canal rays emitting blue-green  $4861 \text{ \AA}$   $H_{\beta}$  spectral line. Increase of wavelength by factor  $\frac{1}{2}(v/c)^2$  with increasing velocity  $v$  of the emitting ions was confirmed <sup>110,111,112</sup>.
- B. Experiments with Co-57  $\gamma$ -ray source at the center of a rotating disk and a resonant Fe-57 absorber at the periphery of the disk. The observed change in the absorption with the rotation speed suggested a change in the peak absorption frequency by factor  $\frac{1}{2}(v/c)^2$  with the increasing velocity  $v$  of the absorber <sup>113,114,115,116</sup>.
- C. Experiment with Co-57  $\gamma$ -ray source at the top and Fe-57 absorber at the bottom of a 75 ft high tower. The observed gravitational shift corresponded to the difference in the gravitational factor between the top and bottom of the tower in the Earth gravitational frame <sup>117,118,119</sup>.
- D. Experiment with cesium clocks flown eastward and westward around the world on commercial airplanes. The experiment confirmed that the hypothetical clock with  $\beta^2 = \delta = 0$  in the Earth

<sup>110</sup> H.E. Ives and G.R. Stilwell, J. Opt. Soc. Am. **28** (1938) 215

<sup>111</sup> H.E. Ives and G.R. Stilwell, J. Opt. Soc. Am. **31** (1941) 369

<sup>112</sup> H.I. Mandelberg and L. Witten, J. Opt. Soc. Am. **52**, 5 (1962) 529

<sup>113</sup> H.J. Hay, J.P. Schiffer, T.E. Cranshaw, and P.A. Egelstaff, Phys. Rev. Letters **4**, 4 (1960) 165

<sup>114</sup> D.C. Champeney, G.R. Isaak, and A.M. Khan, Nature **198**, 4886 (1963) 1186

<sup>115</sup> W. Kundig, Phys. Rev. **129** (1963) 2371

<sup>116</sup> Turner, K.C., and Hill, H.A., Phys. Rev. B, **134** (1964) 252

<sup>117</sup> T.E. Cranshaw, J.P. Schiffer, and A.B. Whitehead, Phys. Rev. Letters **4**, 4 (1960), 163

<sup>118</sup> R.V. Pound and G.A. Rebka Jr., Phys. Rev. Letters **4** (1960) 337

<sup>119</sup> R.V. Pound and J.L. Snider, Phys. Review **140**, 3B (1965) B788

- gravitational frame shall be used as the reference for both the airplane clocks and the Earth station clock<sup>120,121,122</sup>.
- E. One of the most accurate and frequently referred experiments on atomic clocks was carried out in 1976 by sending a hydrogen maser to 10 000 km<sup>123</sup>. The frequency of the maser was monitored via a microwave link to Earth station. For eliminating the Doppler effect, a two-way signal was sent as a reference to the spacecraft and back. The effect of gravitation confirmed the GR/DU prediction. The effect of the velocities of the spacecraft and the Earth station was reported as a confirmation of special relativity based on the relative velocity between the spacecraft and the earth station, which violated the original prediction based on velocities in the ECI frame<sup>124</sup>. A detailed analysis showed that the apparent match with the special relativity prediction was due to an extra term resulting from the Doppler cancellation signal used in the experiment. Corrected analysis showed full match with the GR/DU predictions<sup>125</sup>.
  - F. The Global Positioning System serves as a modern high accuracy test for the effects of motion and gravitation on atomic clocks.

---

<sup>120</sup> J.C. Hafele and R.E. Keating, *Science* **177** (1972) 166

<sup>121</sup> J.C. Hafele, *Nature Phys. Sci.* **229** (1971) 238

<sup>122</sup> R. Schlegel, *Nature Phys. Sci.* **229** (1971) 237

<sup>123</sup> D. Kleppner, R.F.C. Vessot, and N.F. Ramsey, *Astrophysics and Space Science* **6** (1970) 13

<sup>124</sup> R.F.C. Vessot et al., *Phys. Rev. Letters*, **45**, 26 (1980) 2081

<sup>125</sup> [T. Suntola, \*Galilean Electrodynamics\*, \*\*14\*\*, No.4 \(2003\)](#)

## 4. Evaluation of theories on natural sciences

### *Philosophical criteria*

According to Aristotle, the goal of sciences is to create an understandable picture of reality. Further, he stated that best are the sciences that can be derived from primary laws of nature with a minimum number of postulates. Simplicity, understandability, minimum number of postulates, the accuracy of predictions as well as the coverage of theories are generally accepted virtues of theories. In his doctoral thesis *Economical Unification as a Method of Philosophical Analysis* (2016) Avril Styrman presents the Principle of Economy – also called Occam's Razor and the Principle of Parsimony – as a criterion for evaluating scientific theories: the theory which gives more accurate predictions and explanations of the same phenomena is preferred; of two equally accurate theories, the metaphysically simplest is preferred. Metaphysical commitments of a theory are its hypotheses about the existence of things such as laws of nature and concrete objects whose existence has not been empirically verified. Accuracy is the primary and simplicity is the secondary criterion. Of the most accurate theories, economy favors those which explain phenomena by the smallest and the most unified collection of interrelated postulates. Other theoretical virtues such as understandability and applicability are largely derivative from a theory's degree of economy. In many cases, economy and unificatory power are interchangeable.

In physics, the principle of economics emphasizes the postulate bases in common in the different areas of physics. In present theories this is problematic; the theory of relativity has its own postulates which, e.g., omit the conservation of energy essential in thermodynamics and quantum mechanics. Current cosmology needs additional postulates like the dark energy. The structure of quantum mechanics is incompatible with the theory of relativity; quantum mechanics rely on wave function and the probability that and inconsistent in other areas of physics.

### *Current physics*

Postulates in present theories are primarily conclusions from observations. Galileo Galilei based the principle of relativity on his observation that experiments made in uniformly moving ship gave the same results as similar experiments made at rest in the harbor. Einstein extended the coverage of the principle of relativity by adding coordinate transformations associated with the constancy of the velocity of light as “an empirical fact”. Further, Einstein postulated the principle of equivalence, which linked Newton's laws of motion, corrected with the coordinate transformations, to gravitational acceleration. Both the special and general theory of relativity are local theories describing observations relative to the observer. Coordinate transformations based on the kinematic approach of relativity theory created the concept of

space-time as a central factor in the picture of reality conveyed by the theory. The extension of the general theory of relativity into a cosmological theory required the cosmological principle as an additional postulate; accordingly, on a cosmological scale space is homogeneous and isotropic – essentially equal to any observer anywhere in space. The GR based cosmology model was recently complemented with the dark energy that results in pushing gravitation and the accelerating expansion of space. The dark energy was needed to match the observed magnitude-redshift relation of distant supernovas.

In quantum mechanics, mass object, or particle, is described in terms of the wavefunction. Wavefunction has no specific physical meaning; the square of the wave describes the probability of finding a particle at a particular location, at a particular time. Energy states in quantum systems like an atom are solved as discrete states obtained as eigenvalues of Schrödinger's wave equation.

### *Dynamic Universe*

Dynamic Universe is based on the conservation of energy, or more precisely, on the zero-energy principle as a derivative of Aristotle's entelecheia, the actualization of a potentiality. Zero-energy principle follows double-entry bookkeeping; the energy of motion is gained against an equal release of potential energy; in a pendulum motion is gained in the way down and returned to potential energy in the way up. In space the primary potential energy is the gravitational energy; for determining the amount of gravitational energy, the structure of space shall be known. In DU, space is described as the 3D surface of a 4D sphere that closes space in the simplest possible geometry and allows the calculation of the gravitational energy in the structure.

DU is a holistic approach; it relies primarily on spherically closed space and the zero-energy principle. Such an approach allows the study of the dynamics of space as a whole which is the basis for the analysis of local phenomena. Local structures and dynamics are related to the structure and dynamics of whole space. The relativity of local observations is conveyed by the effects of motion and gravitation of the local energy states – which links relativity also to quantum mechanical systems. Mass obtains the meaning of wavelike substance for the expression of energy. Mass objects are described as resonant mass wave resonators, where quantum states are energy minima fulfilling the resonance condition.

In DU, time and distance are universal coordinate quantities consistent with an understandable picture of reality.

### **Theory structures**

Figure 4-1 compares the postulate basis, structural hierarchy, and the development of present theories and Dynamic Universe. The base units, time, distance, mass, and electric charge are the same for each theory structures.

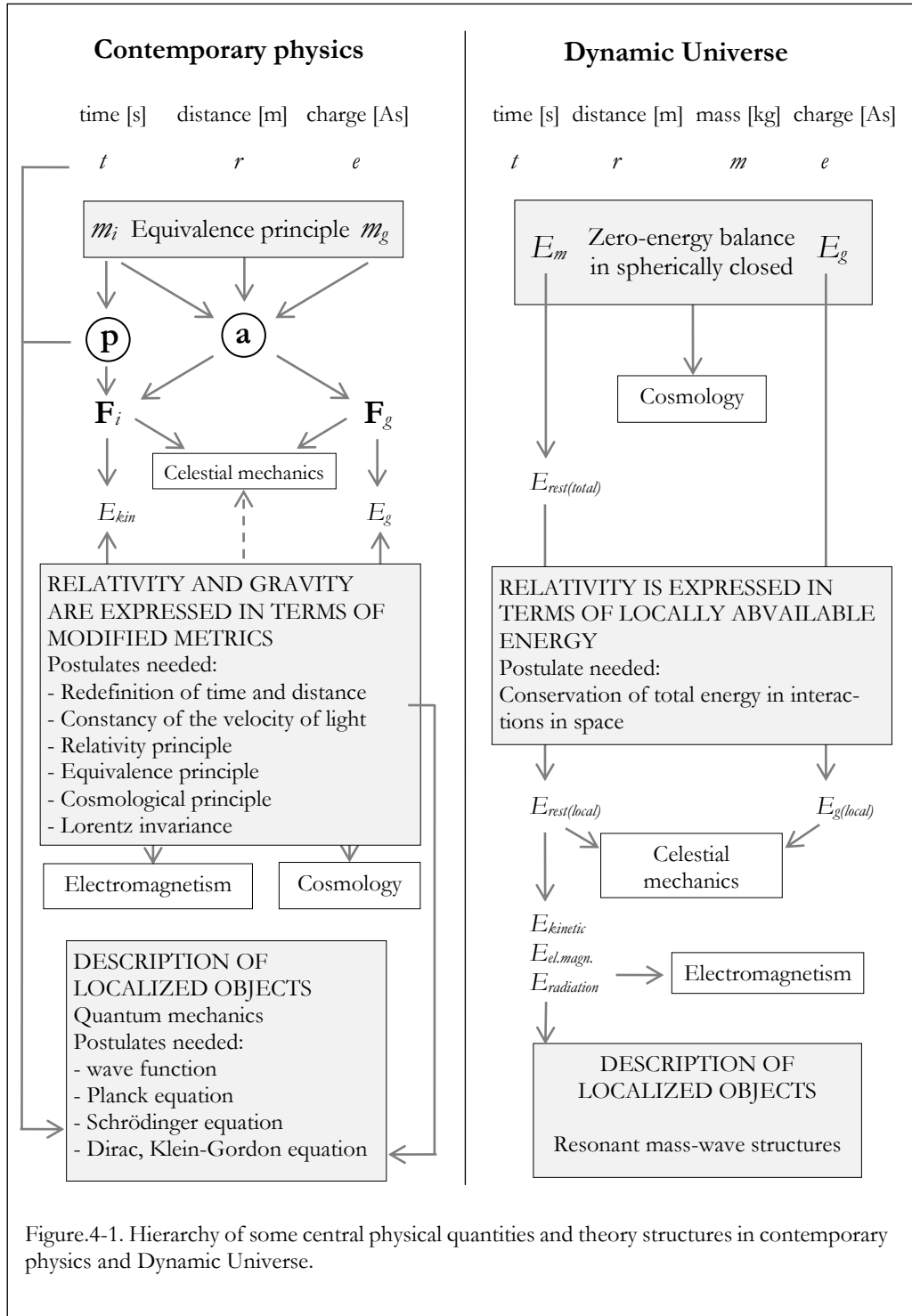

The roots of the current theories are in Newton's laws of motion. Newton linked the inertial force to gravitational force, which made force a fundamental quantity in physics. Implicitly, the linkage defined the equivalence principle that states the equivalence of inertial mass and gravitational mass. Newton's second law of motion defining the relation between force, mass and acceleration obtained the status of a primary law of nature. The solution gave an understandable basis for Kepler's elliptic orbits and allowed precise predictions for the motions and mutual interactions of planets.

In principle, force describes a local interaction with the object studied. Gravitational force described in Newton's physics as an action at a distance which is instant or occurs at a finite velocity. Energy in contemporary physics is a derived quantity as the integrated force.

In DU, energy is the primary quantity and force the gradient of potential energy or the time derivative of momentum. In the case of gravitation, the energy approach can be traced to the potential theory developed by Laplace in the 18th century. Laplace's method based on scalar potential field raised celestial mechanics to a new level. A physical interpretation of Laplace's method means scalar gravitational field as the primary physical entity; the gradient of the scalar field was sensed as an instant gravitational force by a mass object.

Laplace took the scalar field as a mathematical solution – in principle, the scalar field can be interpreted as the primary physical entity that solves the philosophical question of instant gravitational interaction without interaction speed from the sources of the potential field.

#### *Local theory or a system description*

The main difference between "force-based" physics and "energy-based" physics results from the local nature of the force-based approach and the system approach of the energy-based physics.

Force interactions can be studied as mutual interactions between objects following the balance of opposite forces and the equivalence principle linking the gravitational force to the inertial force. Force approach supports the principle of relativity; the state of rest can be fixed in any of the objects studied.

Energy approach relies on the conservation of energy in the system studied. In DU, whole space is the primary energy system studied. The physical reality with its many structures is described as a system of nested energy frames. Locality appears as a local potential energy structure, motion in the frame is obtained against a release of potential energy. The local state of rest in a local frame is a state, where local potential has not been converted into motion.

The expression of relativity in terms of locally available energy and the wave as the substance for the expression of energy shows quantum mechanics as a natural part of general physics and bases to understandable ontology behind quantum phenomena. It looks like the resonance condition illustrated with the base electron states of the hydrogen atom is a fundamental law of nature like the zero-energy principle.



## The principle of economy

### *Theory structures and unification*

As shown in Figure 4-1, present theory structures are the result of a long development history since Galilei's relativity principle and Newton's laws of motion and gravitation. Such a long chain has complicated the theory structures and brought unique postulates and definitions in different branches of physics.

Dynamic Universe has been constructed on "clean table" enabling fewer postulates and simpler theory structure. Most important, however, is the system approach which has made it possible to apply the conservation principle from whole space to smallest particles. The system approach has opened the connection between local and the whole and shown the essence of relativity as a consequence of the finiteness of total resources in space. Relativity becomes a natural feature of quantum mechanics via the rest energy which is a function of the state of motion and gravitation in the local energy frame and through the system of nested energy frames to the state of motion and gravitation in all parent frames. Unification can be seen in the unified expression of the energy and the linkage of local and the whole that shows the complementary connection between the rest energy and global gravitational energy.

Although Dynamic Universe means a major paradigm change, it had not been found without the huge progress obtained with the theory of relativity and all the experiments and observations made for testing the theory.

### *Observations, predictions and the picture of reality*

Dynamic Universe gives answers to many open questions in current physics. Most importantly, it opens an understandable picture of reality by canceling the relativity of time and simultaneity that cannot be matched to observational reality – although mathematically applicable. In DU framework, time and distance have univocal meaning as universal coordinate quantities.

The zero-energy balance links the rest energy of a mass object to the global gravitational energy that serves as the "anti-object" to the local object thus canceling the question of missing antimatter. The linkage of the global gravitational energy to the rest energy also gives a quantitative solution to Mach's principle: the inertial work done in putting a mass object into motion, is the work done against global gravitation.

The problem of the stability of black holes is solved by the DU celestial mechanics, which shows stable slow orbits with the radius close to the critical radius. Such orbits main the mass of the black hole. DU does not need the Big Bang of present cosmology model to build up the energy in space; the rest energy of mass is built up against a release of gravitational energy in a pre-singularity contraction phase.

The simple geometry, univocal dynamics of space and the linkage of local and the whole result in highly simplified, parameter-free predictions for cosmological predictions. A local system in space expands in direct proportion to the expansion of space, which together with the spherical geometry explain the Euclidean appearance

of galaxy space – as well as the circumstances necessary for the early geological development of the Earth and early existence of liquid water on planet Mars.

## Appendix I. Biography gallery

The Gallery is ordered according to the dates of birth of the persons in the gallery. Pictures are from *Wikimedia Commons*.

### Thales (c. 625–546 BC)



Thales of Miletus was a polymath scientist from Miletus in Asia Minor which is now western Turkey. He was most probably influenced by Egyptian astronomy and geometry. Thales is generally referred to as the father of scientific thinking and the pioneer of the Ionian natural philosophy. Thales attempted to explain natural phenomena without reference to mythology and tried to find understandable explanations to natural phenomena.

In Thales's world water constituted the principle of all things – starting from the Earth as a disk floating on water. Thales made astronomical observations and predicted, for example, the solar eclipse in 585 BC as well as eclipses of the Moon. He divided the year into 365 days and determined the occurrences of the vernal and autumnal equinoxes and the summer and winter solstices.

<http://www-history.mcs.st-and.ac.uk/Biographies/Thales.html>

<http://www.iep.utm.edu/thales/>

[http://en.wikipedia.org/wiki/Thales\\_of\\_Miletus](http://en.wikipedia.org/wiki/Thales_of_Miletus)

### Anaksimander (c. 610–546 BC)



Anaximander belonged to the Milesian school as a student and was the successor of Thales and the tutor to Anaximenes (c. 585–525 BC) and Pythagoras (c. 582–496 BC). According to Aristotle's writings Anaximander tried to describe the basic laws of nature and the relation between the Earth and the celestial objects. Anaximander taught that the universe is not monarchic but geometric by its nature and that the cosmic order is characterized by balance and harmony. All matter in the universe is built up of eternal, unlimited *apeiron*. The Earth in the center of the universe is surrounded by space, where the celestial bodies rotate the Earth in three spheres.

Closest to the Earth was the sphere of fixed stars; next the cylinders for the Moon and the Sun.

<http://www-history.mcs.st-andrews.ac.uk/Biographies/Anaximander.html>

<http://www.iep.utm.edu/anaximan/>

<http://en.wikipedia.org/wiki/Anaximander>

## Anaximenes (c. 585–528 BC)



Anaximenes was a student and collaborator of Anaximander and a younger student of Thales. Anaximenes adopted his elder tutor's, Thales's, idea of a basic matter. However, he replaced Thales's water with air that he saw more fundamental than water. According to Anaximenes, all materials, including the flat Earth, were made of condensed air. The idea of condensation may have come, at least partly, from the condensation of air. The choice of air as the primary

substance may also have deeper metaphysical or spiritual roots to the soul and the manifestation of life through breathing. Anaximenes was the first to describe material by the quality pairs hot/dry and cold/wet.

<http://www.iep.utm.edu/anaximen/>

[http://en.wikipedia.org/wiki/Anaximenes\\_of\\_Miletus](http://en.wikipedia.org/wiki/Anaximenes_of_Miletus)

## Pythagoras (c. 570–490 BC)

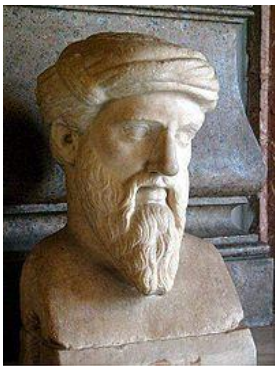

Pythagoras was an Ionian Greek philosopher, mathematician and the founder of Pythagoreanism, who was born in the island of Samos in the eastern Aegean Sea. In his youth Pythagoras travelled in Egypt, in several Middle East countries and probably in India. After the tours, around 530 BC he founded a philosophical and religious school in Croton in southern Italy.

Pythagoras is best known for his geometry and mathematics; among his contemporaries he was known, first of all, for his school with high ethical discipline. Pythagoras was an ascetic and taught an esoteric view of life. In his scale of qualities, highest was “love of wisdom”, next “love of honor”; least was “love of profit or money”.

There are no original writings by Pythagoras extant; most of the information about Pythagoras was written down centuries after he lived. Most probably, many accomplishments known as Pythagoras's ideas originate from his successors, Pythagoreans. One reason for the limited information is that Croton's school assumed strict loyalty and secrecy. In 510 BC, Croton was attacked and defeated its neighbor Sybaris and two years later the Pythagorean Society was attacked by a leading citizen of Croton, who was rejected by the society. Pythagoras left for Metapontium and there is said to have ended his days.

Theorems attributed to Pythagoras or to the Pythagoreans:

The sum of the angles of a triangle is equal to two right angles.

Pythagoras's theorem: for a right-angled triangle the square of the hypotenuse is equal to the sum of the squares of the other two sides.

Constructing figures of a given area and geometrical algebra, for example, solution of the equation  $a(a-x)=x^2$ .

The discovery of irrational numbers.

The cosmological ideas of Pythagoras were guided by his conviction of the mathematical order and simplicity of natural structures. He assumed that the Earth is spherical, and recognized, for example, that the orbit of the Moon was inclined to the equator of the Earth. He was one of the first to realize that Venus as an evening star was the same planet as Venus as a morning star. After Pythagoras, in about 450 BC Oenopides found that the angle between the plane of the celestial equator and the ecliptic plane is about  $24^\circ$ .

<http://www-history.mcs.st-andrews.ac.uk/Biographies/Pythagoras.html>

<http://plato.stanford.edu/entries/pythagoras/>

<http://en.wikipedia.org/wiki/Pythagoras>

## Heraclitus (c. 535–475 BC)



Heraclitus lived in Ephesus, Ionia in Asia Minor close to Miletus. Heraclitus's philosophy comprises an aspiration to deep understanding and empirical knowledge based on observations. Heraclitus was searching for spiritual awareness and a conscious way of life; he felt that most people "live like sleepwalkers" without understanding the world around them. He criticizes his predecessors' lack of ability to see the connections between things. The universal order and law of nature behind all structures and processes is *Logos*. As the law

of nature and a universal consciousness, Heraclitus's *logos* is closely related to the concept of *Brahman* in Indian *Advaita Vedanta* philosophical tradition. Heraclitus stresses the unity of divine power; "To God all things are fair, good and just, but men suppose some things are unjust, some just".

Heraclitus's *Logos* was inherited by the Stoics as the generative and uniting principle of the Universe. Later, in Greek philosophy, *logos* refers more to reasoning, argumentation, and logical thinking.

As in the Chinese Tao tradition, Heraclitus saw the balance of opposites and continuous change as a manifestation of logos in all natural phenomena.

Heraclitus is perhaps best known for the "philosophy of changes" that emphasizes change as the natural condition – in certain contrast to Plato's and Aristotle's search for stability. Plato and Aristotle criticized not only Heraclitus's philosophy of changes but also his ideas of the unity of opposites. The unity of opposites, however, includes the idea of observability via differences; cold is observed in relation to warm and warm in relation to cold. For Heraclitus, fire was the symbol of change and process. Accordingly, fire was not an element or comparable to elements.

In his philosophy of changes Heraclitus expresses the idea of the conservation of matter; “it rain as much as there is evaporation of water” that also precedes Aristotle’s idea of circular causality; “things may be both causes and effects to each other”.

<http://www.illc.uva.nl/~seop/entries/heraclitus/>

<http://www.iep.utm.edu/heraclit/>

<http://en.wikipedia.org/wiki/Heraclitus>

## Parmenides (c. 510 BC)

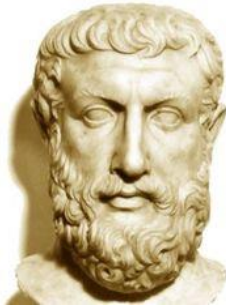

Parmenides was born in the Greek city of Elea, on the southern coast of Italy. Parmenides is the founder of the Eleatic school of philosophy. In Parmenides’s philosophy, reality is eternal and any change in it is impossible – the world as perceived by the senses is unreal. Denying of change may be understood as a reflection of conservation of an overall basic substance and the denial of a void or nothingness. Denial of the existence of a void is contradicted by the atomic hypothesis introduced by Leucippus in about 460 BC. According to Leucippus, everything in the world is either atoms or void.

In Parmenides’s philosophy, *belief* is based on sense-perception and everyday thinking, *reality* is unchanging unity that can be met only by pure consciousness and intuition. Parmenides’s pure consciousness meant consciousness of *logos*, close to the meaning of Heraclitus’s *logos*. After Parmenides, *logos* as used by Socrates, Plato, and Aristotle was more and more related to logical thinking and reasoning. Parmenides’s only known work on philosophy is a poem *On Nature*, which has survived only in fragmentary form.

<http://www.illc.uva.nl/~seop/entries/parmenides/>

<http://www.iep.utm.edu/parmenid/>

<http://en.wikipedia.org/wiki/Parmenides>

*The Parmenides of Plato:* [openlibrary.org](http://openlibrary.org)

*The Fragments of Parmenides:* [openlibrary.org](http://openlibrary.org)

## Anaxagoras (c. 500–428 BC)



Anaxagoras was a student of Anaximenes. He was born in Clazomenae, in Asia Minor and was the philosopher to bring philosophy from Ionia to Athens. Anaxagoras is best known for his idea of *Nous* (mind) as a universal ordering force that had created the visible universe of infinite material substance. The substance was composed of a multitude of imperishable primary elements, referring all generation and disappearance to mixture and separation, respectively. Even the slightest parts of material preserved their connection to the substance as a whole. Anaxagoras’s *nous* was disconnected from the material substance. *Nous* possessed of all knowledge and power ruling in

all the forms of life. Anaxagoras's philosophy was based on a holistic view of reality obtained by meditation; sense-perception could not create the right picture of reality.

<http://www-history.mcs.st-andrews.ac.uk/Biographies/Anaxagoras.html>  
<http://plato.stanford.edu/archives/fall2011/entries/anaxagoras/>  
<http://www.iep.utm.edu/anaxagor/>  
<http://en.wikipedia.org/wiki/Anaxagoras>

## Empedocles (c. 492–432 BC)



Empedocles was a Greek philosopher from the island of Sicily. He is best known for establishing the system of four elements based on fire, water, air, and earth. Empedocles's world was in a continuous change due to opposite forces like love and strife in life and forces of mixing and separation in physics. Empedocles's four elements were eternal – changes were due to the different combinations of the elements.

Empedocles reasoned that the light from the Sun travelled with a finite velocity.

<http://www-history.mcs.st-andrews.ac.uk/Biographies/Empedocles.html>  
<http://plato.stanford.edu/entries/empedocles/>  
<http://www.iep.utm.edu/empedocl/>  
<http://en.wikipedia.org/wiki/Empedokles>

## Philolaus (c. 470–385 BC)



Philolaus was a Pythagorean philosopher and polymath scientist from Croton, in southern Italy. His book *On Nature*, is considered as the first Pythagorean book and the primary source of Pythagorean philosophy for Plato and Aristotle. Philolaus's cosmos consisted of two principles: limiting and limitless or limiter and unlimited. Unlimiteds are universals without form or size such as the four elements, and the continua of space and time. Limiters defined the forms and quantities so that material things could be described in harmony with the unlimited. As an example of the harmony,

Philolaus presented the musical scale, where the pleasing sounds can be expressed in terms of whole number ratios like octave 1:2. In Pythagorean philosophy, the universe is composed of harmonic ratios, and it can be understood only by knowledge of the ratios.

Philolaus may be the first philosopher who abandoned the Earth centered universe. In Philolaus's universe all celestial bodies, including the Earth and the Sun, were revolving around a central fire. Accordingly, the central fire was not the Sun – the Sun was a crystal disk reflecting the light from the central fire. Philolaus is known for having made astronomical observations, although no written documents of the

observations have survived. He defined the length of the synodic month as  $29\frac{1}{2}$  days (the precise value is 29.53) and the length of the solar year as  $365\frac{1}{2}$  days (the precise value is 365.2564).

<http://plato.stanford.edu/entries/philolaus/>  
<http://en.wikipedia.org/wiki/Philolaus>

## Leucippus (400s BC)



The Ionian philosopher Leucippus is generally regarded as the father of atomism. Leucippus is known for his book, *Megas Diakosmos (The Big World-System)*, where he states: “Both matter and void have real existence. The constituents of matter are elements infinite in number and always in motion, with an infinite variety of shapes, completely solid in composition”. He taught that the world is created by agglomerations of atoms by chance collisions. The smaller atoms are sent off into the infinity of space while the rest form into a spherical structure with the larger atoms at

the center.

In spite of his concept of the stochastic motion of atoms, he seems having believed in the purposefulness of life and existence. In his work “*On the Mind*” he states: “*Nothing happens in vain, but everything from reason and of necessity*”.

<http://www-history.mcs.st-andrews.ac.uk/Biographies/Leucippus.html>  
<http://www.iep.utm.edu/leucippu/>  
<http://plato.stanford.edu/entries/leucippus/>  
<http://en.wikipedia.org/wiki/Leucippus>

## Democritus (c. 460–370 BC)



Democritus was born in the city of Abdera, in Ionia. Democritus inherited a major fortune from his father which allowed him to travel widely in Asia, Ethiopia, and India. As a student of Leucippus, Democritus continued the development of his tutor’s atomic theory. Both Leucippus and Democritus presented rationalism combining determinism and materialism. They believed that physical phenomena are controlled by exact laws of nature. Democritus acknowledges causality, but unlike Aristotle and Plato, he described nature and phenomena without

emphasis on first causes or movent. Atomists relied mainly on a mechanistic approach.

Democritus’s universe, like that of Leucippus, was made of material structures. Everything, including the Earth and everything on the Earth, which were formed by atoms agglomerated in chaotic motion. Democritus’s atoms were eternal and invisible; absolutely small, so small that their size cannot be diminished. Atoms were



homogeneous, differing only in shape, arrangement, position, and magnitude. Atoms were independent, mainly in a mechanical interaction with each other.

Democritus's Nature behaved like a machine; it was nothing more than a highly complex mechanism with a beginning and an end; a world could be destroyed by collision with another world that probably referred to a possibility that a celestial body could collide with the Earth. Democritus realized that the Milky Way is formed by distant stars and thought that there may be life in those celestial bodies. Democritus taught that human knowledge cannot grasp the real essence of things – we can only define what we believe the things are.

<http://www-history.mcs.st-andrews.ac.uk/Biographies/Democritus.html>

<http://plato.stanford.edu/entries/democritus/>

<http://www.iep.utm.edu/democrit/>

<http://www.crystalinks.com/democritus.html>

<http://en.wikipedia.org/wiki/Democritus>

## Plato (424–348 BC)

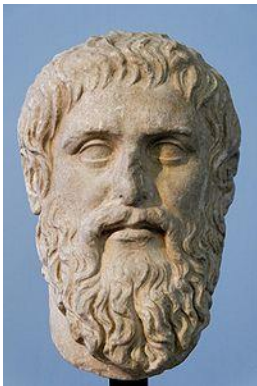

Plato was a student of Socrates (469–399 BC), the founder of the Academy in Athens, and one of the best known antique philosophers. Plato's main activity was directed to general philosophy but he also had a major influence on the development of the natural sciences. In addition to Socrates, Plato was influenced by Heraclitus and Parmenides. Also, he studied Pythagoras's works and came to appreciate the value of mathematics; "... *that the reality which scientific thought is seeking must be expressible in mathematical terms, mathematics being the most precise and definite kind of thinking of which we are capable*".

Plato did not give much value to empirical knowledge, but saw it secondary to intuitive knowledge, the world of ideas that was constant and true. Plato saw mathematics and astronomy as links between the world of observations and the world of ideas. Plato's ideas of nature and natural phenomena were governed by a world soul related to Heraclitus's *logos*. The laws of nature as manifestations of the world soul, were eternal and unchanging – our sense perceptions, however, are continually changing.

<http://www-history.mcs.st-andrews.ac.uk/Biographies/Plato.html>

<http://plato.stanford.edu/entries/plato/>

<http://www.iep.utm.edu/plato/>

<http://en.wikipedia.org/wiki/Plato>

Plato (1914), [openlibrary.org](http://openlibrary.org)

George Burges, *The Works of Plato* (1850): [openlibrary.org](http://openlibrary.org)

## Eudoxus (c. 408–355 BC)

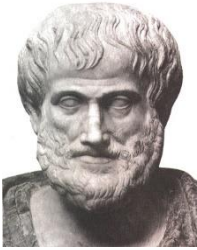

Eudoxus was a student of Plato – also, he studied astronomy and mathematics in Heliopolis in Egypt. Following the Pythagorean tradition, Eudoxus’s thinking was directed to numbers and harmonic relation. In addition to rational numbers he studied irrational numbers and, as a precursor to the integral calculus, he solved the areas limited by mathematical functions by geometrical methods.

Eudoxus introduced the idea of the spherical shape of celestial bodies and illustrated the Earth with a globe map. In the 370s BC, he developed the epicyclic system used in the geocentric planetary model. As a complement to the epicyclic model, Plato’s students Euctemon and Meton observed the unsymmetry of the vernal and autumnal equinoxes between the summer and winter solstices. In the planetary model, the unsymmetry was solved by moving the center of the Sun’s orbit out of the Earth.

Eudoxus saw his planetary model as a geometric construction for the illustration of planetary motions. Aristotle describes the model in his *Metaphysics* by interpreting it as the real mechanism of planetary motions.

<http://www-history.mcs.st-andrews.ac.uk/Biographies/Eudoxus.html>

[http://en.wikipedia.org/wiki/Eudoxus\\_of\\_Cnidus](http://en.wikipedia.org/wiki/Eudoxus_of_Cnidus)

## Heraclides (c. 387–312 BC)



Heraclides of Ponticus was a polymath scientist and astronomer from Heraclea Pontica in present Turkey. He was a student in the Plato Academy. He had writings on astronomy, mathematics, music, poetry, and rhetoric. Also, he was interested in Pythagorean mystics.

Most probably, Heraclides was the first to propose that the apparent motion of the skies is due to the rotation of the Earth around its axis once a day. He observed that, at least Mercury and Venus orbit the Sun. His Pythagorean colleagues, Ecphantus and Hicetas shared Heraclides’s view. It is possible that Ecphantus and Hicetas were not actual persons but characters in Heraclides’s dialogues.

<http://www-history.mcs.st-andrews.ac.uk/Biographies/Heraclides.html>

<http://plato.stanford.edu/entries/pythagoreanism>

[http://en.wikipedia.org/wiki/Heraclides\\_Ponticus](http://en.wikipedia.org/wiki/Heraclides_Ponticus)

## Aristotle (384–322 BC)

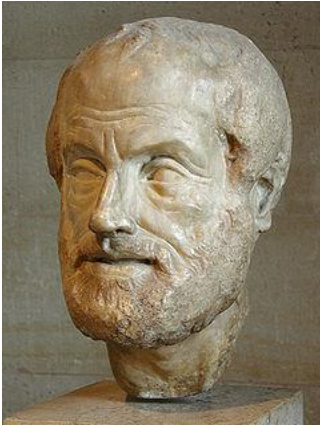

Aristotle was born in Stageira, Chalcidice peninsula in north-eastern Greek. As a son in an aristocratic family, he received a good basic education in Athens. At the age of eighteen Aristotle entered Plato's Academy, where he continued his studies and philosophical work for almost twenty years. After the Academy, he traveled in Asia Minor. In 343 BC, the king of Macedon invited him to become the tutor to his son Alexander the Great, and the head of the royal academy of Macedon. Aristotle encouraged Alexander the Great toward eastern conquest. In 335 BC, Aristotle returned to Athens and established his own school, *Lycceum*.

Aristotle is generally regarded as one of the greatest and most influential philosophers of all time – not least due to the large number of writings like *Physics*, *Metaphysics*, *Ethics*, *Politics*, *Soul*, and *Poetry* that have survived. As a whole, his works serve as a comprehensive source to ancient Greek philosophy and science.

In the natural sciences, Aristotle's physics was the most authoritative work up until the Middle Ages. Aristotle's physics is largely qualitative rather than quantitative. In modern terms it is closer to philosophy than natural science. In addition to its descriptions of matter and motion, it described the mechanisms of the human mind, body and senses as well as the general principles of metaphysics.

Like Plato, Aristotle saw that reality, as defined as the scope of scientific research, exists independently of the presence of an observer. Scientific models can be regarded as descriptions of such reality.

The basis and motivation of Aristotelian science is the natural human desire to know and understand. He saw that the basis of science and arts is in finding the first causes; observations and experience produce knowledge, but not wisdom that presumes knowledge about first causes and the principles of nature. Science strives for recognition of first causes. For that, one should study the principles and substances behind phenomena as well as the causes triggering the changes [Metaphysics, book I, part 3].

<http://www-history.mcs.st-andrews.ac.uk/Biographies/Aristotle.html>

<http://plato.stanford.edu/entries/aristotle/>

<http://www.iep.utm.edu/aristot/>

Plato, *Physics*, [https://en.wikisource.org/wiki/Physics\\_\(Aristotle/Wikisource\\_translation\)](https://en.wikisource.org/wiki/Physics_(Aristotle/Wikisource_translation))

A.E. Taylor, *Aristotle* (1912): [openlibrary.org](https://openlibrary.org)

Aristotle Metaphysics: <http://classics.mit.edu//Aristotle/metaphysics.html>

Aristotle Physics: <http://classics.mit.edu//Aristotle/physics.html>

Aristotle Categories: <http://classics.mit.edu/Aristotle/categories.html>

Aristotle, e-books [openlibrary.org](https://openlibrary.org)

Thomas Aquinas, *Commentary on Aristotle's Physics*, <http://dhspriority.org/thomas/Physics.htm>

## Euclid (c. 350–280 BC)



Euclid was a Greek mathematician influential in Alexandria. Euclid may also have studied in Plato's Academy. He is best known for Euclidean geometry; non-Euclidean geometry was first recognized in the late 1800s AD. Euclid's book *Elements* is one of the most highly valued books in the history of mathematics. In the *Elements*, Euclid deduced the principles of Euclidean geometry from a small set of axioms.

Euclid also studied and published treatises on perspective, spherical geometry, conic sections, and number theory.

<http://www-history.mcs.st-andrews.ac.uk/Biographies/Euclid.html>

<https://www.biographyonline.net/scientists/euclid.html>

*Elements*: <http://farside.ph.utexas.edu/Books/Euclid/Elements.pdf>

## Epicurus (341–270 BC)

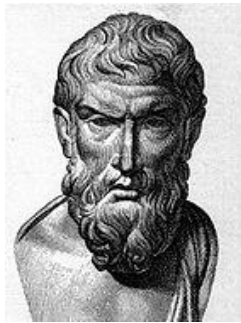

Epicurus was a Greek philosopher and a member of Plato's Academy in Athens. Later, he established a school of his own, "The Garden" that gradually became one of the three centers of philosophy. Unlike pre-Socratic philosophers, he emphasized the role of observations and sense perceptions and tried to renounce the tradition of serving of gods. Epicurus presented a materialistic view of life; for him the universe was infinite and eternal. Events in the world were ultimately based on the motions and interactions of atoms moving in empty space.

Epicurus was a pioneer in the development of the empirical scientific method; he insisted that nothing should be believed, except that which was tested through direct observation and logical deduction.

In Epicurus's philosophy the best for the human being is pleasure. Pleasure is obtained by exercising reasonableness and by looking for wisdom as well as by friendship with other people.

Epicurus adopted Democritus's atomic theory in spite of the opposite opinion of Aristotle. In the Aristotelian interpretation the non-continuous matter made of discrete atoms would require non-continuous time and motion as well. Epicurus defended his view by explaining that, although the atom is indivisible, there is no minimum to the length of motion. In any case, Epicurus thought that for atoms the laws of motion are different from the laws of macroscopic bodies, and that time and motion are discontinuous.

<http://plato.stanford.edu/entries/epicurus/>

<http://www.iep.utm.edu/epicur/>

<http://en.wikipedia.org/wiki/Epicureanism>

<http://en.wikipedia.org/wiki/Epicurus>

## Aristarchus (310–230 BC)



Aristarchus was a Greek philosopher and astronomer from the island of Samos. Aristarchus is often referred to as the Greek Copernicus; he suggested a heliocentric system with all planets and the Earth orbiting around the Sun. His model is mainly known through his students and Archimedes's writings. Some of Aristarchus's contemporaries mention his heliocentric model in writings defending the epicyclic system.

Archimedes cites Aristarchus's model as follows: *"His hypotheses are that the fixed stars and the sun remain unmoved, that the earth revolves about the sun on the circumference of a circle, the sun lying in the middle of the orbit, and that the sphere of fixed stars, situated about the same center as the sun, is so great that the circle in which he supposes the earth to revolve bears such a proportion to the distance of the fixed stars as the center of the sphere bears to its surface."* Aristarchus assumed that the sphere of the fixed stars was essentially larger than the orbits of the Earth and the planets, most probably for explaining why the observer on the Earth sees the fixed stars as if from the center of the sphere of the fixed stars.

Like Heraclides, Aristarchus assumed that the daily rhythm is due to the rotation of the Earth, which in fact was a direct consequence of the assumption of the fixed Sun and the fixed stars.

The Stoic Cleanthes claimed Aristarchus was irreverent in his attitude toward the gods when putting the center of the universe into motion: *"Aristarchus set the Sun among the fixed stars and holds that the earth moves around the Sun's circle, and is put in shadow according to its inclinations"*. This statement shows that Aristarchus had explained the seasons in terms of the inclination of the Earth<sup>1</sup>. In his book *On the Sizes and Distances of the Sun and Moon* that has survived to modern times, Aristarchus concludes the ratio of the distances to the Sun and the Moon by measuring the angle between the two objects at half moon. His result was about 87° which gave the estimate of 20 to the distance ratio. The real angle in the half moon position is about 89°50', and the correct ratio of the distances almost 400.

Because the angular size of the Sun and the Moon are about the same (when observed from the Earth), the diameters of the Sun and the moon have the same ratio as the corresponding distances. By following the motion of the Earth's shadow on the Moon at the eclipse of Moon, Aristarchus concluded, that the diameter of Moon is half of the diameter of the Earth, which was about twice the correct number. Aristarchus estimated that the diameter of the Sun is about seven times the diameter of the Earth (the correct number is about 100). Aristarchus's measurements, however, were quite respectable in regard to the instruments available at his time.

<http://www-history.mcs.st-andrews.ac.uk/Biographies/Aristarchus.html>

<http://www.archive.org/stream/aristarchusorpr00withgoog>

[http://en.wikipedia.org/wiki/Aristarchus\\_of\\_Samos](http://en.wikipedia.org/wiki/Aristarchus_of_Samos)

<sup>1</sup>T. Heath, *Aristarchus of Samos, the Ancient Copernicus* (1913) [openlibrary.org](https://openlibrary.org)

## Archimedes (c. 287–212 BC)

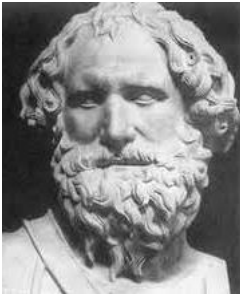

Archimedes was one of the most notable mathematicians of antiquity and of all times. He was not only a mathematician but also a philosopher, physicist, engineer, and astronomer. Archimedes was born in the city of Syracuse, on the east coast of the island Sicily. According to folk tales the defense of the city against Roman attacks was said to have been based on the war machines that Archimedes designed.

Archimedes developed the mathematical methods of Eudoxus for the calculation of surface areas and volumes, which provided a basis for the integral calculus. Probably, he was also the first mathematician who applied geometrical series. By using polygons inside and outside a circle, Archimedes solved the numerical value of pi to three decimals.

Archimedes defined the basic rules for the calculation of the center of mass of systems of bodies. In his book *On Floating Bodies* Archimedes describes, for example, the famous Archimedes's principle, which stated that a body immersed in a fluid experiences a buoyant force equal to the weight of the fluid it displaces.

<http://www-history.mcs.st-andrews.ac.uk/Biographies/Archimedes.html>

<http://en.wikipedia.org/wiki/Archimedes>

T.L. Heath, *The Works of Archimedes*, [openlibrary.org](http://openlibrary.org)

T.L. Heath, *Geometrical solutions derived from mechanics: a treatise of Archimedes*, [openlibrary.org](http://openlibrary.org)

T.L. Heath, *The Method of Archimedes*, [openlibrary.org](http://openlibrary.org)

## Eratosthenes (276–194 BC)



Eratosthenes was a Greek mathematician, geographer, poet, athlete, astronomer, and music theorist born in the city of Cyrene in modern-day Libya. Eratosthenes is known as the father of geography. He, for example, introduced the system of latitude and longitude, calculated the tilt of the Earth's axis, the distance from the Earth to the Sun, and was the first person to use the term "geography". Eratosthenes calculated the circumference of the Earth by measuring the angle of the Sun at noon in two locations; in the modern day Aswan and in Alexandria, about 800 km to the north from Aswan, where the Sun appeared at zenith (directly overhead) on the solstice noon. In Alexandria, the Sun appeared at the angle of  $7.2^\circ$  to the vertical direction, measured from the shadow of a vertical rod. Related to the distance between Aswan and Alexandria, about 5000 stadia, the estimate of the circumference of the Earth was 252 000 stadia equal to 46 250 km, assuming that he was using the stadia equal to 185 meters. If he was using the stadia equal to 157 meters, which was another "standard" for the ancient stadia, the estimate of the Earth circumference would have been 39 250km, which is only about 2% smaller than the modern day estimate. Eratosthenes's estimate for the length of the year was  $365\frac{1}{4}$  days and proposed that a leap day be added to the year every fourth year.

<http://www-history.mcs.st-andrews.ac.uk/Biographies/Eratosthenes.html>  
<http://en.wikipedia.org/wiki/Eratosthenes>

## Apollonius (noin 262–190 eKr.)



Apollonius of Perga was a Greek mathematician and astronomer, known as "The Great Geometer". He was born in Anatolia, in modern day Turkey. In his book *Conicus* he presents the principles of conic sections and names the particular cases as *parabola*, *ellipse*, and *hyperbola*.

Apollonius made substantial contributions to the epicyclic planetary model. In particular, he made a study of the points where a planet appears stationary, namely the points where the forward motion changes to a retrograde motion or the converse. He explained the varying speed of the Moon with the eccentricity of the orbit by placing the center of the orbit slightly away from the center of the earth. In his book *On the Burning Mirror* Apollonius showed that parallel rays of light are not brought to a focus by a spherical mirror and discussed the focal properties of a parabolic mirror

<http://www-history.mcs.st-andrews.ac.uk/Biographies/Apollonius.html>  
[http://en.wikipedia.org/wiki/Apollonius\\_of\\_Perga](http://en.wikipedia.org/wiki/Apollonius_of_Perga)

## Hipparchus (c. 190–120 BC)



Hipparchus was a Greek astronomer, geographer, and mathematician born in Nicaea, (now Iznik, Turkey) who is regarded as the pioneer of scientific astronomy. The basis of his work can be tracked back to Babylonian astronomers.

Hipparchus defined, with high accuracy, the equinoxes, and the length of the year, 365 days 5 hours and 55 minutes. Also, he recalculated the distances of the Sun and the Moon, earlier determined by Aristarchus, his estimate for the distance to the Moon was between 59 and 67 Earth radii (the correct value is 60 radii).

Hipparchus is perhaps best known for his discovery of precession which is due to the slow change in direction of the axis of rotation of the Earth. He collected a catalogue of fixed stars and developed trigonometric methods for astronomy. Hipparchus published his results in the book *Peri eniausíou megéthous* (*On the Length of the Year*) that is referred to in Ptolemy's *Almagest*.

There are speculations that Hipparchus studied the heliocentric model of Aristarchus but rejected it because the orbits turned out not to be complete circles.

<http://www-history.mcs.st-andrews.ac.uk/Biographies/Hipparchus.html>  
<http://www.crystalinks.com/hipparchus.html>  
<http://en.wikipedia.org/wiki/Hipparchus>

## Seleukos (noin 190–150 eKr.)

Seleucus of Seleucia was one of the few antique astronomers supporting the Aristarchus heliocentric model, and the first to defend the heliocentric system by reasoning – possibly by applying the trigonometric methods developed by Hipparchus. Seleucus assumed the universe to be infinite. He ascribed tides both to the Moon and to a whirling motion of the Earth, which could be interpreted as the motion of the Earth around the Earth-Moon center of mass.

[http://en.wikipedia.org/wiki/Seleucus\\_of\\_Seleucia](http://en.wikipedia.org/wiki/Seleucus_of_Seleucia)

## Klaudios Ptolemaios (noin 85–165 jKr.)



Claudius Ptolemy was a mathematician, astronomer, geographer, astrologer – a Roman citizen, who lived in Alexandria in Egypt. Ptolemy's best known work *Mathematike Syntesis* or *Almagest* is a thorough treatise of the astronomical and geographic knowledge of his time.

*Almagest* consists of thirteen Books. Book I gives a general introduction of Aristotle's geocentric astronomy and an introduction to spherical trigonometry. Book II discusses the daily motions of the celestial bodies, the length of the day and its dependence on the observer's position on the Earth. Book III discusses the length of the year and the motion of the Sun. Ptolemy introduces Hipparchus's discovery of the precession of the equinoxes and begins explaining the theory of epicycles.

Books IV, V, and VI cover the motion of the Moon, the lunar parallax, the motion of the lunar apogee, the sizes and distances of the Sun and Moon relative to the Earth, and the solar and lunar eclipses. Books VII and VIII introduce the constellations with tables of stars, and discusses the motions of fixed stars and the precession of the equinoxes. By comparing his own observations with those made by Meton and Hipparchus about 300 years earlier, he concludes that the positions of the fixed stars have been unchanged. The last five books discuss the motions of the planets.

In his work *Geography*, consisting of eight books, he maps the known world giving coordinates of the major places in terms of latitude and longitude. In his work *Optics*, Ptolemy studies color, reflection, refraction, and mirrors of various shapes.

Ptolemy's *Almagest* maintained its position as the basic reference and authority in astronomy for about 1500 years.

<http://www-history.mcs.st-andrews.ac.uk/Biographies/Ptolemy.html>

<http://en.wikipedia.org/wiki/Ptolemy>

<http://en.wikipedia.org/wiki/Almagest>

*Almagestum*: [http://www.univie.ac.at/hwastro/books/1515\\_ptole\\_ColMed.pdf](http://www.univie.ac.at/hwastro/books/1515_ptole_ColMed.pdf)

R. Fitzpatrick, *A Modern Almagest*, <http://farside.ph.utexas.edu/Books/Syntaxis/Almagest.pdf>

Karl Manitius, *Des Claudius Ptolemäus Handbuch der Astronomie* (1912) [openlibrary.org](http://openlibrary.org)



## John Philoponus (490–570)



John Philoponus was a Christian philosopher, polymath scientist, and theologian, who lived in Alexandria in Egypt. He was one of the first philosophers criticizing Aristotle's physics. Philoponus published treatises on logic, mathematics, physics, astronomy, cosmology, psychology, theology, and church politics.

Philoponus criticized Aristotle's dynamics and proposed the concept of *impetus* to explain the continuation of motion. Instead of Aristotle's external movent, an object moves and continues to move because of *impetus* (*incorporeal motive energeia*), the energy given to the object by the mover, and ceases movement when *impetus* is exhausted. Philoponus extended the concept of impetus to planetary motions; the vacuum in space does not resist the motion and remove *impetus* from the planets. Philoponus also assumed that the non-material light carries *impetus*.

Philoponus also questioned the antique conception of eternal space. Philoponus and his ideas were more than one thousand years "ahead of his time"; Galileo Galilei refers to Philoponus's works with high respect.

<http://plato.stanford.edu/entries/philoponus/>

<http://en.wikipedia.org/wiki/Philoponus>

Ioannes Philoponus, *De Aeternitate Mundi* [openlibrary.org](http://openlibrary.org)

C. Widberg, *John Philoponus' Criticism of Aristotle's Theory of Aether* (1988) [google books](http://googlebooks)

## Jean Buridan (c. 1300–1360)



Jean Buridan was a priest and philosopher born in Béthune in France. Buridan had a long career as an arts master in Paris and served twice as university rector. In addition to his teaching career, his creative philosophical thinking led him to develop further the concept of impetus to explain projectile motion. Buridan defined impetus as the product of the mass and velocity of the moving object – which defined impetus as the *momentum*.

Buridan's writings are primarily his comments on Aristotle's works that he had used as his lecture notes. His main book *Summulae de dialectica* (*Compendium of Dialectic*) was a comprehensive textbook on logic; in his book he replaced the traditional Aristotelian logic with the newer, terminist logic that he also applied in ethics and in metaphysics and the natural sciences. Buridan's books became popular in European universities.

Philoponus's impetus described the essence of Aristotle's movent maintaining a motion. Like Philoponus, Buridan rejected the Aristotelian idea of the spontaneous dilution of the movent and assumed that the possible dilution of impetus results from a force resisting the motion. Such a force could be the gravitation or the resistance of the medium. Accordingly, the motion of an object would continue forever in absence of a resisting force.

Buridan wrote: "... after leaving the arm of the thrower, the projectile would be moved by an impetus given to it by the thrower, and would continue to be moved as long as the impetus remained stronger than the resistance, and would be of infinite duration were it not diminished and corrupted by a contrary force resisting it or by something inclining it to a contrary motion <sup>1</sup>"

Buridan realized that the acceleration of a falling object is due to increasing impetus, which is proportional to the weight and velocity of the object. Buridan saw that the concept of impetus applies also to celestial bodies; orbital motion is not associated with a change in the gravitational state and celestial bodies do not experience the resistance of air; accordingly, they continue to move at constant velocity.

Jean Buridan may have been the first to think about an oscillating pendulum in a "tunnel experiment" related to a body in a fictitious tunnel through the globe. The basic principle in the tunnel experiment, or in any pendulum, is that the velocity obtained in the fall is able to bring the body to the same height the fall had begun.

In his treatise *De Caelo* published in 1357, Buridan's pupil Dominicus de Clavasio wrote about impetus: "When something moves a stone by violence, in addition to imposing on it an actual force, it impresses in it a certain impetus. In the same way gravity not only gives motion itself to a moving body, but also gives it a motive power and an impetus ...".

<http://plato.stanford.edu/entries/buridan/>

[http://en.wikipedia.org/wiki/Jean\\_Buridan](http://en.wikipedia.org/wiki/Jean_Buridan)

[http://en.wikipedia.org/wiki/Theory\\_of\\_impetus](http://en.wikipedia.org/wiki/Theory_of_impetus)

<sup>1</sup> T.F.Glick, S.J.Livesay, F.Wallis, *Medieval Science, Technology and Medicinean Encyclopedia (2005)*, p. 107

## Ibn al-Shatir (1304–1375)

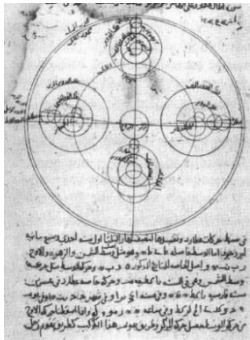

Ibn al-Shatir was an Arab Muslim astronomer, mathematician, engineer, and inventor who worked as the religious timekeeper in the Umayyad Mosque in Damascus, Syria. In his best known astronomical treatise, *Kitab nihayat al-sul fi tashih al-usul (The Final Quest Concerning the Rectification of Principles)*, he introduced an alternative model to the Ptolemaic planetary system. Ibn al-Shatir's model is geocentric; he was not looking for an ontological theory, but a practical description of observations. In his model, Ibn al-Shatir eliminated the Ptolemaic eccentrics and equant by using *Tusi-complexes*, creating small circles circulating in larger circles with double the radius, which led to a better accuracy than the Ptolemaic epicycle model.

In spite of its geocentric structure, Ibn al-Shatir's model had certain mathematical connections to Copernicus's heliocentric model. In his *De Revolutionibus*, Copernicus expresses his gratitude to the Muslim mathematician Muhammad al-Battān (858–929 AD), a predecessor of Ibn al-Shatir, for the mathematical methods he had developed.

[http://en.wikipedia.org/wiki/Ibn\\_al-Shatir](http://en.wikipedia.org/wiki/Ibn_al-Shatir)

## Nicolaus Copernicus (1473–1543)

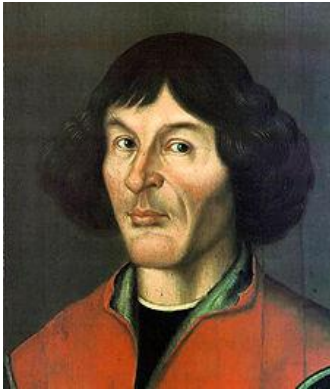

Nicolaus Copernicus was born on 19 February 1473 in the city of Thorn, in the province of Royal Prussia, in the Crown of the Kingdom of Poland. Nicolaus was the youngest of the four children in the family. When Nicolaus was at the age of ten, his father died and his maternal uncle, Lucas Watzenrode the Younger became guardian to Nicolaus. As a canon at Frauenburg Cathedral, Lucas Watzenrode guided his protégé's studies for fulfilling a canon's competence.

After completing the cathedral school of Włocławek in central Poland, Copernicus entered the University of Kraków, where he studied mathematics and the basics of astronomy. His tutor in astronomy was Albert Brudzewski, who was a professor of Aristotelian philosophy but taught astronomy privately outside the university. In this connection Copernicus became familiar with Georg von Peurbach's (1423–1461) book *Theoricæ novæ planetarum* (*New Theories of the Planets*), published in 1454. Peurbach was loyal to the Ptolemaic geocentric model, but in his book, he contemplates the possibility that the Sun controls the motions of the planets.

The textbook of astronomy was Johannes de Sacrobosco's (1195 – c. 1256) *Tractatus de Sphaera* (*On the Sphere of the World*) published in about 1220. In addition to the Ptolemaic astronomy, the book gave an overview of Islamic astronomy. Sacrobosco is known to have also been acquainted with Arabic mathematics.

When staying in Kraków, Copernicus bought a Latin translation of Euclid's *Elements*, published in Venice in 1482, the *Alfonsine Tables* dealing with computation of the positions of the Sun, the Moon, and the planets, and the *Tables of Directions* on spherical astronomy. After the Swedish wars in the Baltic countries and Poland, Copernicus's library was taken to the library of Uppsala University.

In 1496–1501, Copernicus continued his studies in Bologna, mainly concentrating on canon law. In Bologna Copernicus met the famous Italian astronomer Domenico Maria Novara de Ferrara, and worked as his assistant. He became familiar with the overviews of Ptolemy's *Almagest*, written by Georg von Peurbach and Johannes Regiomontanus. Copernicus verified certain peculiarities in the Ptolemy theory of the Moon's motion, by conducting on 9 March 1497 at Bologna a memorable observation of Aldebaran, the brightest star in the Taurus constellation, the results of which reinforced his doubts as to the geocentric system. He was looking for more evidence on his doubts by reading writings from the antiquity such as the biographies of Pythagoras, Plato, Philolaus, Heraclides, Ecphantos, and Aristarchus written by Plutarch in about 45–125 AD.

In addition to his astronomical activities, Copernicus studied medicine, the Greek language and completed his doctorate in canon law. In 1503, at the age of 30, after completing all his studies, he returned to Warmia in Poland, where he was his uncle's secretary and physician until his uncle's death in 1512. In November in 1512, he



Ptolemaic model of the spheres for Venus, Mars, Jupiter, and Saturn in Georg von Peurbach's *Theoricæ novæ planetarum*. The points in the center:

C[entrum] æquantis (center of equant)  
 C[entrum] deferentis (center of deferent)  
 C[entrum] mundi (the center of the world). Figure, *Wikimedia Commons*.

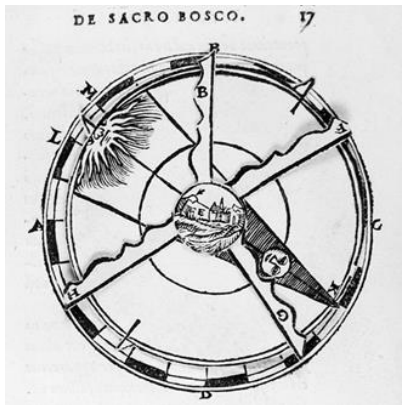

Ptolemaic model of the spheres for Venus, Mars, Jupiter, and Saturn in Georg von Peurbach's *Theoricæ novæ planetarum*. The points in the center:

C[entrum] æquantis (center of equant)  
 C[entrum] deferentis (center of deferent)  
 C[entrum] mundi (the center of the world). Figure, *Wikimedia Commons*.

took on his uncle's duties as canon in the Ermland Chapter at Frauenburg. The canon's position gave him more time and facilities for his astronomical interests; he was able to build an observatory in the rooms in which he lived in one of the towers in the town's fortifications.

Copernicus collected his ideas on the heliocentric system in a 40-page treatise *Commentariolus* that he gave to his colleagues who had been working in Krakow between 1515 and 1530. A printed version of *Commentariolus* was published later, in 1878.

In 1533, Johann Widmanstetter, the secretary to Pope Clement VII, introduced Copernicus's heliocentric system to the Pope and two cardinals. The Pope's first reaction was positive; the first attacks to Copernicus's work came from a Dutch protestant, Wilhelm Gnapheus. In his comedy *Morosophus* (*The Foolish Sage*) Gnapheus mocked Copernicus by caricaturing him as a haughty, cold, aloof man "who dabbled in astrology, considered himself inspired by God, and was rumored to have written a large work that was moldering in a chest".

At that time Copernicus may have completed the manuscript of his main work, *De revolutionibus orbium coelestium*. He, however, delayed the printing so that the book was published in 1543, the year Copernicus died, thanks to Georg Joachim Rheticus, a young professor of mathematics and astronomy at the University of Wittenberg. In May 1539, Rheticus had arrived at Frauenburg to study Copernicus's system. The same year, the mayor of Danzig gave Rheticus some financial assistance to help publish the *Narratio Prima*, also titled as *First report to Johann Schöner on the Books of the Revolutions of the learned gentleman and distinguished mathematician, the Reverend Doctor Nicolaus Copernicus of Torun, Canon of Warmia, by a certain youth devoted to mathematics*.

*Narratio Prima* was received well, which encouraged Copernicus to complete and publish the full theory that he had promised 27 years earlier.

In the preface of the book, devoted to the Pope, Copernicus explains his work on the re-evaluation of the motions of the celestial bodies by referring to the shortcomings in the prevailing theory, and refers to the state of astronomy:

... For, in the first place, they are so uncertain about the motion of the sun and moon that they cannot establish and observe a constant length even for the tropical year. Secondly, in determining the motions not only of these bodies but also of the other five planets, they do not use the same principles, assumptions, and explanations of the apparent revolutions and motions. For while some employ only homocentrics, others utilize eccentrics and epicycles, and yet they do not quite reach their goal...

... But meanwhile they introduced a good many ideas which apparently contradict the first principles of uniform motion. Nor could they elicit or deduce from the eccentrics the principal consideration, that is, the structure of the universe and the true symmetry of its parts. On the contrary, their experience was just like some one taking from various places hands, feet, a head, and other pieces, very well depicted, it may be, but not for the representation of a single person; since these fragments would not belong to one another at all, a monster rather than a man would be put together from them...

In the preface, Copernicus referred to Philolaus, Heraclitus, and Ecphantus the Pythagorean as the first to propose a moving Earth. Copernicus warned the Pope of inappropriate attacks against the book. He mentions, for example, Lactantius (c. 240–340 AD), who “speaks quite childishly about the Earth’s shape, when he mocks those who declared that the Earth has the form of a globe”.

<http://plato.stanford.edu/entries/copernicus/>

<http://www-history.mcs.st-andrews.ac.uk/Biographies/Copernicus.html>

<http://en.wikipedia.org/wiki/Copernicus>

The *Commentariolus*, <http://dbanach.com/copernicus-commentariolous.htm>

*De revolutionibus orbium coelestium*, <http://www.webexhibits.org/calendars/year-text-Copernicus.html>

## Sir Thomas Digges (1546–1595)

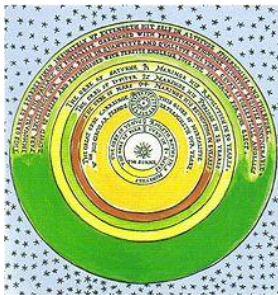

Thomas Digges was an English mathematician and astronomer, one of the first astronomers supporting Copernicus’s theory and the first to write about Copernicus’s ideas in English. In his application for financial support for his work he stated that his motive was to find out “... whether the monstrous system of celestial globs ... has been fully corrected and amended by that divine Copernicus, of more than human talent, or whether there still remains something else to be further considered...”.

Digges translated part of Copernicus’s work, *De Revolutionibus*, into English. He removed Copernicus’s description of the sphere of the fixed stars and replaced that with his own idea of an infinite number of fixed stars located in unlimited space behind the sphere of fixed stars. Digges may be the first person to contemplate the problem of “the dark night sky paradox” created by the unlimited number of stars.

<http://www-history.mcs.st-andrews.ac.uk/Biographies/Digges.html>

<http://en.wikipedia.org/wiki/File:ThomasDiggesmap.JPG>

[http://galileo.rice.edu/Catalog/NewFiles/digges\\_tho.html](http://galileo.rice.edu/Catalog/NewFiles/digges_tho.html)

F R Johnson, *The Influence of Thomas Digges on the Progress of Modern Astronomy in 16th Century England*, *Osiris* 1 (1936), 390-410.

## Tycho Brahe (1546–1601)

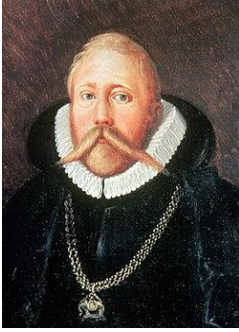

Tycho Brahe was a Danish nobleman and astronomer born in Scania (Skåne), in modern day Sweden. Since the age of two, in 1548, Tycho lived in Tostrup Castle commanded by his uncle, and after 1552 in Vordingborg Castle given to his uncle's command.

At the age of 12, Tycho Brahe began his studies at the University of Copenhagen by studying law as proposed by his uncle, and also a variety of other subjects like astronomy. Inspired by the predicted eclipse of the Sun in 1560, he concentrated on astronomy and purchased literature on the subject. After a couple of years, he moved to Leipzig where the main areas of his studies were classical languages and culture, but he had his astronomy books along and he had an opportunity to make astronomical observations. In 1563, at the age of 17, Tycho observed a conjunction of Jupiter and Saturn which proved significant for his subsequent career. To his great surprise, the time of the conjunction deviated by nearly a month from the prediction based on Ptolemy's tables, and by a few days from that in Copernicus's tables.

In 1571, after the death of his father and uncle, Tycho Brahe began constructing an observatory and an alchemy laboratory in Herrevad Abbey. In November 1572, he saw a new star light up in the constellation of Cassiopeia, almost directly overhead. That was the 1572 supernova explosion. He found that the object did not change its position relative to the fixed stars over several months, which indicated that the new star was not a planet, but a fixed star in the stellar sphere beyond all the planets. Such a conclusion was in conflict with the prevailing doctrines of unchanging fixed stars. This observation motivated Tycho Brahe to focus more on astronomy and precise observations.

Tycho Brahe tried to match his observations to Heraclides's geocentric model in which Mercury and Venus orbited the Sun and, together with the Moon and the outer planets, orbited the Earth. Tycho Brahe placed all the planets into orbits around the Sun but let the heliocentric solar system and the Moon orbit the Earth. Tycho Brahe's model was a kind of compromise between the Ptolemy's and Copernicus's models.

With the support of the king of Denmark, Tycho Brahe got a new observatory and a research center, Uraniborg, on the island of Hven in 1576, and then in nearby Stjerneborg in 1581. In 1599, he moved to Prague with his family. In Prague he, together with his assistant, Johannes Kepler, published the *Rudolphine tables*, named after his sponsor, Rudolf II, the Holy Roman Emperor. In spite of the fact that Tycho Brahe rejected Copernicus's model, he greatly appreciated Kepler's work:

<http://www-history.mcs.st-andrews.ac.uk/Biographies/Brahe.html>

[http://en.wikipedia.org/wiki/Tycho\\_Brahe](http://en.wikipedia.org/wiki/Tycho_Brahe)

## Giordano Bruno (1548–1600)



Giordano Bruno was an Italian philosopher, mathematician and astronomer, and a Dominican friar. He is known to have been interested in Arabic astrology, Neoplatonism, Renaissance Hermeticism, and the ideas of Averroism, a Christian philosophy based on an interpretation of Aristotle's works through the Muslim philosopher Averroes, who saw that reason and philosophy are superior to faith and knowledge founded on faith. Bruno, however, criticized Aristotle's physics.

Bruno understood the importance of the Copernican system. In fact, he took one more step by explaining that the Sun should be understood as one of the uncountable number of stars. Bruno's radical ideas led finally to a deep crisis with the church. The Roman Inquisition declared that his views on physics and cosmology were theological and demanded that he retract them. Bruno tried to convince the Inquisition that his views were in accord with Christianity. Pope Clement VIII demanded that Bruno should be sentenced as a heretic and the Inquisition passed the death sentence on him. On hearing the sentence, he responded: "*Perhaps your fear in passing judgment on me is greater than mine in receiving it*".

In his work *On Cause, Principle, and Unity* Bruno wrote:

*"This entire globe, this star, not being subject to death, and dissolution and annihilation being impossible anywhere in Nature, from time to time renews itself by changing and altering all its parts. There is no absolute up or down, as Aristotle taught; no absolute position in space; but the position of a body is relative to that of other bodies. Everywhere there is incessant relative change in position throughout the universe, and the observer is always at the center of things."*

[http://www-history.mcs.st-andrews.ac.uk/Biographies/Bruno\\_Giordano.html](http://www-history.mcs.st-andrews.ac.uk/Biographies/Bruno_Giordano.html)

<https://plato.stanford.edu/entries/bruno/>

[http://en.wikipedia.org/wiki/Giordano\\_Bruno](http://en.wikipedia.org/wiki/Giordano_Bruno)

J. Lewis McIntyren, *Giordano Bruno* (1903) [openlibrary.org](https://openlibrary.org)

Eva Martin, *Giordano Bruno, Mystic and Martyr* (1921) [openlibrary.org](https://openlibrary.org)

## Francis Bacon (1561–1626)



Francis Bacon was an English philosopher, statesman, scientist, lawyer and author. He was one of the pioneers of the empirical scientific method. In his work *Novum Organum Scientiarum—True directions Concerning the Interpretation of Nature*, he explained that science was guided by the Aristotelian deductive method proceeding from postulates to conclusions, instead of inductive reasoning based on observed facts. The preface of his book begins with the statement: "*Those who have taken it on themselves to lay down the law of nature as something that has already*

*been discovered and understood, whether they have spoken in simple confidence or in a spirit of professional posturing, have done great harm to philosophy and the sciences*". He continues that

“...Some people on the other hand have gone the opposite way, asserting that absolutely nothing can be known – having reached this opinion through dislike of the ancient sophists, or through uncertainty and fluctuation of mind, or even through being crammed with some doctrine or other”.

In his book *Novum Organum* Bacon crystallized his ideas to 180 aphorisms in two parts.

<http://plato.stanford.edu/entries/francis-bacon/>

<http://www.iep.utm.edu/bacon/>

[http://en.wikipedia.org/wiki/Francis\\_Bacon](http://en.wikipedia.org/wiki/Francis_Bacon)

Francis Bacon, *The New Organon: True Directions Concerning the Interpretation of Nature*

<http://www.earlymoderntexts.com/authors/bacon>

MacAlay & S.R. Gardiner, *Francis Bacon, Selections with Essays* [openlibrary.org](http://openlibrary.org)

John Nichol, *Francis Bacon, His Life and Philosophy* (1901) [openlibrary.org](http://openlibrary.org)

## Galileo Galilei (1564–1642)

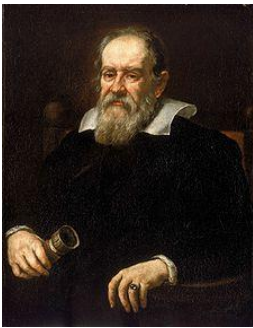

Galileo Galilei was an Italian physicist, mathematician, astronomer, and philosopher. He was born in the city of Pisa, in northern Italy, as the eldest of the six children in the family. Galileo Galilei is perhaps best known as the first astronomer to use the telescope and he was a firm defender of the heliocentric Copernican system. Galilei was able to combine his practical talents in the construction of instruments with his ability to make accurate observations and his mathematical ability to analyze the results.

Galilei started his scientist's career as a lecturer of mathematics and Aristotle's philosophy in Florence and Siena in the 1580s. He was interested in studying motion, and for weighing light test bodies he constructed a hydrostatic balance.

Galileo Galilei was fully convinced of the heliocentric system – most probably due to its clarity and mathematical beauty shown by Kepler. To argue his view, he however, had to base his arguments on detailed observations rather than on the superiority of the system in principle. He made his best to get the church's approval and blessing to his ideas, but finally, he was condemned to lifelong imprisonment for spreading a false doctrine. However, the sentence was carried out as house arrest instead of imprisonment. Galilei's *Dialogo*, which he wrote for defending his ideas, was banned for almost 200 years.

Galilei's problems with the church began to escalate around 1610. In December 1613, a prior student of Galilei, the professor of mathematics in the University of Pisa, defended the Copernican system in his letter to the Duchess of Tuscany. The next year, the Dominican priest Tommaso Caccini attacked Galilei and other supporters of the Copernican heretic doctrine.

In December 1615, Galilei went to Rome in order to defend his Copernican thoughts and to persuade the Catholic Church authorities not to ban Copernicus's ideas. In January 1616 the Sacred Congregation explained to the Inquisition that the proposition that the Sun is the center of the Universe was formally heretic, and the



idea that the Earth is in annual orbital motion, was philosophically absurd and theologically wrong. The cardinals of the Inquisition met on 24 February 1616 and took evidence from theological experts. They condemned the teachings of Copernicus, and Cardinal Bellarmine conveyed their decision to Galileo who had not been personally involved in the trial. Galileo was forbidden to hold Copernican views.

At this stage Galileo was allowed to defend himself and the case was quiescent for several years. In 1621, Galilei was appointed as the Consul of the Accademia Fiorentina. In 1624, the Pope assured him that he could write about the Copernican theory as long as he treated it as a mathematical hypothesis.

Galilei's answer was the famous dialog *Dialogo dei due massimi sistemi del mondo (Dialogue Concerning the Two Chief World Systems)*. In the *Dialogue*, the wise philosopher *Salviati* defends the Copernican system and criticizes Aristotelian physics supported by an apparently simple-minded philosopher *Simplicio* dedicated to traditional views. A representative of common sense, an intelligent layman, *Sagredo*, is initially neutral but adopts the Copernican system in the course of the discussion.

Galileo was examined by the Inquisition in 1633. They banned the book and Galilei was condemned to abjure his errors in front of the Inquisition and sentenced to spend the rest of his life arrested in his apartment. A warning example of refusing an abjuration occurred in 1600 when Giordano Bruno was burned at the stake for heresy for his pantheism and his cosmological views.

In 1638, Galilei tried to measure the velocity of light by trying to observe whether or not light appeared instantaneously from lanterns turned on and off at a distance of a mile. Fast switching of the lanterns was performed with shutters. For understandable reasons, Galilei stated that it was not possible to determine the velocity with this experiment.

<http://www-history.mcs.st-and.ac.uk/Biographies/Galileo.html>

<http://plato.stanford.edu/entries/galileo/>

[http://en.wikipedia.org/wiki/Galileo\\_Galilei](http://en.wikipedia.org/wiki/Galileo_Galilei)

<http://galileo.rice.edu/galileo.html>

[http://en.wikipedia.org/wiki/Dialogue\\_Concerning\\_the\\_Two\\_Chief\\_World\\_Systems](http://en.wikipedia.org/wiki/Dialogue_Concerning_the_Two_Chief_World_Systems)

[http://en.wikisource.org/wiki/Catholic\\_Encyclopedia\\_%281913%29/Galileo\\_Galilei](http://en.wikisource.org/wiki/Catholic_Encyclopedia_%281913%29/Galileo_Galilei)

Sister Maria Celeste, *The Private Life of Galileo* (1870), [openlibrary.org](http://openlibrary.org)

T. Salusbury, *Dialogo* [openlibrary.org](http://openlibrary.org)

## Johannes Kepler (1571–1630)



Johannes Kepler was a German mathematician, astronomer, and astrologer born in the city of Weil der Stadt close to modern day Stuttgart in Germany. He is best known for the laws of planetary orbits bearing his name.

Kepler's unusual competence in mathematics was observed at an early age. He was interested in astronomy, but the smallpox he had in his childhood weakened his vision and crippled his hands, which limited his possibilities in observational astronomy, and might have influenced him to orient himself toward

mathematical astronomy. In 1598, Kepler went to the University of Tübingen, where he studied philosophy, Theology, and Ptolemaic astronomy. Kepler's tutor, Michael Maestlin, also introduced the Copernican system to a small group of students. Maestlin taught that the preface of Copernicus's *De Revolutionibus*, which explained that the system was just a mathematical model, was not written by Copernicus himself. Kepler, who was looking for mathematical beauty in nature was immediately impressed by Copernicus's work and saw it of more value than just a mathematical model.

Kepler's first major astronomical work, *Mysterium Cosmographicum* (*The Cosmographic Mystery*), published in 1596, was the first published defense of the Copernican system. Kepler was looking for the mathematical structure of the planetary system from a set of regular polygons bound by one inscribed and one circumscribed circle at definite ratios, which, he reasoned, might be the geometrical basis of the universe.

Tycho Brahe was convinced of Kepler's *Mysterium Cosmographicum* and, in 1600, invited Kepler to work as his assistant in Prague. The cooperation, which was not without difficulties, was discontinued abruptly in 1601 by Tycho Brahe's unexpected death. Kepler was nominated to be Tycho Brahe's successor and he received all Brahe's observations for his use. It turned out that Brahe's observations of planet Mars were of special importance. After many unsuccessful attempts, 1605 he realized that *the orbit of Mars is an ellipse with the Sun in one of the focal points* (Kepler's first law). Before this he had observed that the orbital velocities of the Earth and the planet Mars were at their maxima at the perihelion point and lowest at aphelion, when the orbital radii of the bodies are at their maximum. This led to Kepler's second law: *A line joining a planet and the Sun sweeps out equal areas during equal intervals of time.*

Kepler published his first two laws in 1609, in his book *Astronomia nova* (*New Astronomy*). In 1618, Kepler found his third law defining the size and the period of the orbits: *The square of the orbital period of a planet is directly proportional to the cube of the semi-major axis of its orbit.* He added the third law to his already completed book *Harmonices mundi libri* (*The Harmony of the Worlds*).

Kepler was convinced of the mathematical beauty of nature, and believed that the structures observed in celestial bodies are repeated in all natural structures, such as in atoms, the building blocks of matter. The mathematical description of the planetary system was an important step towards mathematical physics – at the same time it appeared as a step towards a mechanistic picture of reality. Kepler's orbits were of crucial importance to Newton's laws of motion and gravitation. Kepler's mathematical descriptions were based on Copernicus's structural model and Tycho Brahe's accurate observations.

<http://galileo.rice.edu/sci/kepler.html>

<http://www-history.mcs.st-and.ac.uk/Biographies/Kepler.html>

<http://www.science.uva.nl/~seop/entries/kepler/>

[http://en.wikisource.org/wiki/Author:Johannes\\_Kepler](http://en.wikisource.org/wiki/Author:Johannes_Kepler)

Walter W. Bryant, *Kepler* (1920), [openlibrary.org](http://openlibrary.org)

*Mysterium Cosmographicum*, (1595), <https://archive.org/details/den-kbd-pil-22002200031E-001>

*Harmonices mundi libri*, [http://posner.library.cmu.edu/Posner/books/pages.cgi?call=520\\_K38PI&layout=vol0/part0/copy0](http://posner.library.cmu.edu/Posner/books/pages.cgi?call=520_K38PI&layout=vol0/part0/copy0)

## Thomas Hobbes (1588–1679)

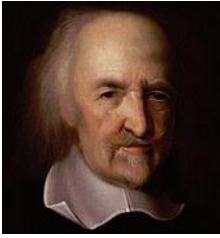

Thomas Hobbes was an English philosopher best known for his political philosophy. In addition to philosophy, he also studied the physics of gases, geometry, theology, and ethics.

Thomas Hobbes studied also the concept of *conatus*, and gave it the meaning of the initiator or precursor of motion. According to Hobbes, the initiator of motion may be, for example, a spring or an elastic material storing force for expansion or contraction. He explains his ideas on natural philosophy in his book *De Corpore (Concerning Body)* published in 1655.

<http://www-history.mcs.st-and.ac.uk/Biographies/Hobbes.html>

<http://www.science.uva.nl/~scop/entries/hobbes/>

<http://en.wikipedia.org/wiki/Hobbes>

Sir William Molesworth, *English works of Thomas Hobbes of Malmesbury* (1839) [openlibrary.org](http://openlibrary.org)

Hobbes: Leviathan Part 1: <http://www.earlymoderntexts.com/authors/hobbes>

Hobbes–Wallis controversy: [http://en.wikipedia.org/wiki/Hobbes-Wallis\\_controversy](http://en.wikipedia.org/wiki/Hobbes-Wallis_controversy)

## René Descartes (1596–1650)



René Descartes was a French philosopher, mathematician, and author. He was born in the city La Haye en Touraine, which was later renamed after him, the city of Descartes. At the age of eight René Descartes entered the Jesuit Collège Royal Henry-Le-Grand at La Flèche and studied classics, logic, traditional Aristotelian philosophy, and mathematics. In 1615 or 1616, he received a degree and a license in civil and canon law at the University of Poitiers.

Soon after his graduation he moved to Holland, and became a volunteer for the army of Maurice of Nassau. After a kind of internal awakening, he abandoned the “study of books” and wanted to find wisdom from his own mind and via the experiences gathered by living. Inspired by the Dutch philosopher and polymath scientist, Isaac Beeckman, he used his free time to study mathematics. Descartes travelled in several countries in Europe, but spent most of his life in Holland, where he also published most of his writings. He was just completing his first work on physics, *Le Monde (The World)*, in 1633, when he heard about Galilei’s arrest and sentence. This frightening news, made him delay the publication of his book, because it contained some strong argumentation for the Copernican heliocentric system. A complement to *Le Monde* was *La géométrie (Geometry)* that describes the Cartesian coordinate system and Cartesian geometry.

In 1641, Descartes published the book *Meditationes de Prima Philosophia (Meditation on First Philosophy)*, in 1644 the book *Principia Philosophiæ (Principles of Philosophy)*, and in 1649, the book *Les Passions de l’âme (Passions of the Soul)*.

Rene Descartés died in 1650 in Stockholm, where he had been invited to serve as the tutor to Queen Christina of Sweden. In 1663, the Pope placed his works on the Index of Prohibited Books.

<http://www-history.mcs.st-andrews.ac.uk/Biographies/Descartes.html>

<http://www.science.uva.nl/~seop/entries/descartes/>

<http://www.earlymoderntexts.com/authors/descartes>

<http://www.iep.utm.edu/descarte/>

<http://en.wikipedia.org/wiki/Descartes>

*Discourse on the Method* (1637): <http://www.earlymoderntexts.com/assets/pdfs/descartes1637.pdf>

*Meditations on First Philosophy* (1641): <http://www.earlymoderntexts.com/assets/pdfs/descartes1641.pdf>

*Objections to the Meditations, and Descartes's Replies* (1642): <http://www.earlymoderntexts.com/assets/pdfs/descartes1642.pdf>

*Correspondence with Princess Elisabeth* (1643-9): <http://www.earlymoderntexts.com/assets/pdfs/descartes1643.pdf>

*Principles of Philosophy* (1644): <http://www.earlymoderntexts.com/assets/pdfs/descartes1644.pdf>

*Conversation with Burman* (1648): <http://www.earlymoderntexts.com/assets/pdfs/descartes1648.pdf>

*The Passions of the Soul* (1649): <http://www.earlymoderntexts.com/assets/pdfs/descartes1649.pdf>

## Pierre de Fermat (1601–1665)



Pierre de Fermat was a French lawyer at the Parlement of Toulouse. He was an amateur mathematician who was an important contributor to the development of integral and differential calculation, analytical geometry, and number theory.

Pierre de Fermat developed methods for the determination of the tangents and the minima and maxima of different mathematical curves as well as for determining the center of gravity of various plane and solid figures. He may also have been the first to determine the integrals of general power functions.

Pierre de Fermat was an inspirer to René Descartes, Gottfried Leibniz, and Isaac Newton, who later on stated that Fermat's way of drawing tangents opened his mind to the development of integral and differential calculus. Together with Blaise Pascal, Pierre de Fermat made a major contribution to the groundwork for the theory of probability.

Pierre de Fermat is also known for the *principle of least time* as a manifestation of the principle of least action. Applying the principle of least time is an easy way of calculating, for example, the refraction of light at a lens or the surface of water.

<http://www-history.mcs.st-and.ac.uk/Biographies/Fermat.html>

<http://en.wikipedia.org/wiki/Fermat>

## Ismael Boulliau (1605–1694)



Ismael Boulliau (or Bullialdus) was a French priest, a notary by profession, and an amateur astronomer. He was an active supporter of the theories and ideas of Johannes Kepler, Galileo Galilei, and Nicolaus Copernicus. However, he argued that the gravitational force proportional to the inverse of the distance, as suggested by Kepler, should be replaced by a force proportional to the square of the inverse of the distance. His conclusion was based on the spreading of light and the related decrease of the intensity in proportion to the square of the distance from the source. Boulliau published several treatises on mathematics and astronomy. The best known of these may be *Astronomia philolaica* from 1645.

<http://www-history.mcs.st-and.ac.uk/Biographies/Boulliau.html>

[http://en.wikipedia.org/wiki/Ismael\\_Boulliau](http://en.wikipedia.org/wiki/Ismael_Boulliau)

## John Wallis (1616–1703)



John Wallis was an English mathematician who had an important role in the development of the basis of the integral and differential calculus and in the works of Isaac Newton and Gottfried Leibniz. John Wallis was born in Ashford, Kent, in southeastern England.

His skills and willingness in learning was seen at an early age at the Tenterden Grammar School. In 1630, still only 13 years of age, he considered himself ready for university. In his autobiography in 1635 he stated that “...*mathematics suited my humour so well that I did thenceforth prosecute it, not as a formal study, but as a pleasing diversion at spare hours...*”.

In 1633, he went to Emmanuel College Cambridge, where took the standard Bachelor of arts degree and, since nobody at Cambridge at this time could direct his mathematical studies, he took a range of topics such as ethics, metaphysics, geography, astronomy, medicine and anatomy. Wallis received his Master's Degree in 1640. He was appointed chaplain in Yorkshire, and later in Essex and in London. He became adept in the cryptologic art and exercised it on behalf of the parliamentary party. His unusual skills in cryptography were related to his phenomenal ability in mental arithmetic. He is said to have solved square roots by mental calculation to tens of decimals.

In 1649, Wallis was appointed to the Savilian Chair of Geometry at the Oxford University. He remained in Oxford until his death on 28 October 1703.

Wallis wrote several treatises on mathematics. The most important of these is *Arithmetica infinitorum* published in 1656. In this treatise, the methods of analysis of Descartes and Cavalieri were systematized and extended. Two of his other well-known

books are, *Tract on Conic Sections* (1655), and *Treatise on Algebra* (1685), in which he gives a rich historical review of the development of mathematics. In addition to mathematics, he published several books on theological themes.

<http://www-history.mcs.st-and.ac.uk/Biographies/Wallis.html>

[http://en.wikipedia.org/wiki/John\\_Wallis](http://en.wikipedia.org/wiki/John_Wallis)

*A Treatise of Algebra, both Historical and Practical* (1685), front page, preface:

<http://mathdl.maa.org/mathDL/46/?pa=content&sa=viewDocument&nodeId=2591&bodyId=3037>

Hobbes–Wallis controversy: [http://en.wikipedia.org/wiki/Hobbes-Wallis\\_controversy](http://en.wikipedia.org/wiki/Hobbes-Wallis_controversy)

## Blaise Pascal (1623–1662)



Blaise Pascal was a French mathematician, physicist, inventor, author, and a catholic philosopher born in Paris. Blaise Pascal's father decided that Blaise was not to study mathematics before the age of 15 and all mathematics texts were removed from their house. Blaise, however, started to work on geometry himself at the age of 12. He discovered that the sum of the angles of a triangle are two right angles. When Blaise's his father got to know about this, he relented and allowed Blaise a copy of Euclid's *Elements*.

Pascal wrote significant treatises on geometry and conic sections at the age of 16. In 1642, in an effort to ease his father's endless calculations of taxes owed and paid, Pascal, not yet nineteen, constructed a mechanical calculator capable of addition and subtraction. In 1648, Pascal observed that the pressure of the atmosphere decreases with height and deduced that a vacuum existed above the atmosphere, which was against the general belief at that time.

In the 1650s Pascal corresponded with Pierre de Fermat for the development of the calculus of probabilities, which laid important groundwork for Leibniz's formulation of the infinitesimal calculus. His *Traité du triangle arithmétique* (*Treatise on the Arithmetical Triangle*) of 1653 described the well-known Pascal's triangle for a convenient tabular presentation for binomial coefficients.



Pascal's calculator, 1642.

Pascal began to publish anonymous works on religious topics in the 1650s. His work contains *Pascal's wager* which claims to prove that belief in God is rational with the following argument: "If God does not exist, one will lose nothing by believing in him, while if he does exist, one will lose everything by not believing". With *Pascal's wager* he uses probabilistic and mathematical arguments, but his main conclusion is that ...we are compelled to gamble.

<http://www-history.mcs.st-and.ac.uk/Biographies/Pascal.html>

<http://www.science.uva.nl/~seop/entries/pascal/>

[http://en.wikipedia.org/wiki/Blaise\\_Pascal](http://en.wikipedia.org/wiki/Blaise_Pascal)

Blaise Pascal, *Thoughts* (1910), [openlibrary.org](http://openlibrary.org)

Blaise Pascal, *Pensées* (1669), [wikisource.org](http://wikisource.org)

Blaise Pascal, *Of the Geometrical Spirit*, [wikisource.org](http://wikisource.org)

## Giovanni Cassini (1625–1712)



Giovanni Cassini was an Italian-French astronomer, astrologer, mathematician, and engineer who is best known for his observations related to the moons of Jupiter, Saturn, and Mars. Cassini was born in Imperia, at that time of the republic of Genova on the northeastern coast of modern-day Italy.

From 1648 to 1669, he was a professor of astronomy at the University of Bologna, and an astronomer at the Panzano Observatory, near Bologna in Italy. In 1671, he became the director of the Paris Observatory.

While working in Bologna, he determined the rotation times of Jupiter, Mars, and Venus. In the Paris Observatory, he found four moons of Saturn, and the “Cassini Division” in the rings of Saturn in 1675.

<http://www-history.mcs.st-and.ac.uk/Biographies/Cassini.html>

[http://en.wikipedia.org/wiki/Giovanni\\_Domenico\\_Cassini](http://en.wikipedia.org/wiki/Giovanni_Domenico_Cassini)

## Robert Boyle (1627-1691)



Robert Boyle was an English natural philosopher, chemist, physicist, and inventor. He is one of the pioneers of modern chemistry. Boyle was born in Lismore Castle, in the County of Waterford in Ireland. He is known best for “Boyle’s law” that states the relation between the volume and pressure of gas in a closed space.

Before his studies at Eton College in England he had received private tutoring in Latin, Greek, and French. After Eton, Boyle travelled in Europe, visiting, among other countries, France and Italy, where he studied the works of

Galileo Galilei in 1641.

After returning to England in 1644, he joined the “Invisible College” formed by a group who devoted themselves to the cultivation of the “new philosophy”. The Invisible College is seen as the seed of the Royal Society, or *the Royal Society of London for the Improvement of Natural Knowledge*, established in 1663.

After his stay in Ireland for a few years, Boyle returned to England in 1654. After he heard of Otto von Guericke’s air-pump he, with the assistance of Robert Hooke, made improvements to it and constructed the “Pneumatic Engine” which he used

for many experiments to study the properties of air. The results were published in the book *New Experiments Physico-Mechanical, Touching the Spring of the Air, and its Effects...*, in 1659.

Boyle's book, *The Sceptical Chymist*, became a basic work in chemistry, raising chemistry from alchemy to a science. Boyle required experimental proof of theories. He was a strong supporter of the atomic theory; he believed that material is composed of atoms and groups of atoms, and that all phenomena can be explained in terms of motions and collisions of particles.

Boyle was a pioneer of empiricism and attacked the ambiguous definitions and concepts in Aristotle's physics. In the preface of his book *The Grounds for and Excellence of the Corpuscular or Mechanical Philosophy*, he limits his corpuscular philosophy to matter and material bodies excluding anything concerning mind.

<http://www-history.mcs.st-and.ac.uk/Biographies/Boyle.html>

<http://www.science.uva.nl/~seop/entries/boyle/>

[http://en.wikipedia.org/wiki/Robert\\_Boyle](http://en.wikipedia.org/wiki/Robert_Boyle)

Flora Mason, *Robert Boyle, a Biography* [openlibrary.org](http://openlibrary.org), [wikisource.org](http://wikisource.org)

Robert Boyle, *Sceptical Chymist* (1661), [wikisource.org](http://wikisource.org)

Robert Boyle, *The Grounds for and Excellence of the Corpuscular or Mechanical Philosophy*:

<http://www.earlymoderntexts.com/assets/pdfs/boyle1674a.pdf>

Robert Boyle, *The Origin of Forms and Qualities, Part 1*: <http://www.earlymoderntexts.com/assets/pdfs/boyle1666.pdf>

## Christiaan Huygens (1629–1695)



Christiaan Huygens was a Dutch mathematician, astronomer, physicist and horologist born in The Hague. His father was a friend of René Descartes, who influenced Christiaan's interest in mathematics. Christiaan studied law and mathematics at the University of Leiden and the College of Orange in Breda. After a time as a diplomat, Huygens turned to science. In physics, his most important achievements were the formula for the period of a pendulum, the formula for centrifugal force, the refinement of René Descartes's concept of momentum, and the wave theory of light and the basis of optics.

Huygens's work included early telescopic studies elucidating the nature of the rings of Saturn and the discovery of its moon Titan, and he constructed both pendulum and spring clocks.

In 1668, The Royal Society proposed the development of the theory of elastic collisions to the mathematicians John Wallis, Christopher Wren, and Christiaan Huygens. Each one of them sent essentially similar answers, based on the conservation of momentum.

In his book *Traité de la lumière* (*Treatise on light*<sup>1</sup>), published in 1690, Huygens discusses the velocity of light and gives an analysis of the measurement made by Ole Rømer



from the Io moon of Jupiter. Huygens's estimate for the velocity of light in Rømer's experiment was about 600,000 times the velocity of sound, which corresponds to about 210,000 km /s. Based on the result, he states his doubt of the infinite velocity of light proposed by Descartes, which was based on Descartes's analysis of the eclipses of the Moon. Huygens showed that the observations of the eclipse of the Moon show only that the propagation time of light from the Moon is less than 10 seconds (the actual propagation time is about one second).

Huygens's wave theory of light was primarily based on his experiments on reflection, refraction, and interference of light. His theory, however, was overshadowed for a century by Newton's corpuscular theory, until the experiments and theoretical considerations by Thomas Young and Augustin-Jean Fresnel in the early 19<sup>th</sup> century confirmed Huygens's conclusions and the status of wave theory as the primary description of light and optical phenomena.

Huygens had high respect for Isaac Newton's works in general. However, he held a different opinion of the nature of light and doubted the universal gravitational force of Isaac Newton.

Maybe the most important work by Huygens is his *Horologium oscillatorium sive de motu pendularium* (*Theory and design of the pendulum clock*), published in 1673. In the book he discusses the theory of the pendulum, centrifugal force, and pendulum clocks.

In a letter to the German mathematician Tschirnhaus, written in 1687, Huygens explained his approach: "... *great difficulties are felt at first and these cannot be overcome except by starting from experiments ... and then by conceiving certain hypotheses ... But even so, very much hard work remains to be done and one needs not only great perspicacity but often a degree of good fortune*".

<sup>1</sup> <http://www.gutenberg.org/files/14725/14725-h/14725-h.htm>  
<http://www-history.mcs.st-andrews.ac.uk/Biographies/Huygens.html>  
[http://en.wikipedia.org/wiki/Christiaan\\_Huygens](http://en.wikipedia.org/wiki/Christiaan_Huygens)

## Christopher Wren (1632–1723)



Christopher Wren was one of the most highly valued English architects, who, among other things, redesigned tens of churches destroyed in the great fire of London in 1666. He is also known as an astronomer, mathematician, and physicist with an important role in the establishment and development of the Royal Society in London. Christopher Wren was born at East Knoyle, in Wiltshire in South West England. Despite being sickly as a child, he survived to the ripe old age of 90 years.

As a young boy, Christopher Wren showed an interest in drawing and in sciences. At the age of nine, after receiving private tutoring at home, he entered the Westminster School in London. An important inspirer of Wren was the husband of his elder sister, the mathematician William Holder, who taught him

mathematics and encouraged him to study astronomy and the art of making observations. After leaving the Westminster school in 1646, he continued working in the science by constructing sundials, models of the solar system, and demonstration models to illustrate how muscles worked – which his tutor in medicine, Dr. Scarborough, used in his course of anatomy lectures.

In 1649, Christopher Wren continued his studies in Wadham College in Oxford. His scientific interest was wide, ranging from astronomy to anatomy; he was an unusual talent in constructing instruments for demonstrating theories and many kinds of physical phenomena.

In 1657, Christopher Wren was nominated Professor of Astronomy at Gresham College in London. He had a clear view of the connection between a centripetal force proportional to the inverse square of the distance and an elliptic orbit – the connection that Isaac Newton solved mathematically 30 years later – after Wren, in the Royal Society, had announced a competition for finding the solution.

In 1661–73, Wren served as the Savilian Professor in Oxford. Wren’s activity together with his colleagues in the “Invisible College” led to the establishment of the Royal Society in 1662. At that time, he was also active in architecture and started the design of St. Paul’s Cathedral and a large number of other works after the London fire in 1666.

In addition to all of his other activities, Wren made important findings in geometry and mathematics that helped Newton in solving problems in celestial mechanics and the formulation of the *Principia*.

<http://www-history.mcs.st-and.ac.uk/Biographies/Wren.html>

[http://en.wikipedia.org/wiki/Christopher\\_Wren](http://en.wikipedia.org/wiki/Christopher_Wren)

Lena Milman, *Christopher Wren* (1908), [openlibrary.org](http://openlibrary.org)

## Robert Hooke (1635–1703)



*Elements.*

Robert Hooke was an English natural philosopher, architect and polymath, who is known for his many works on microscopy, for the development of numerous mechanical devices, and for his many empirical studies in the Royal Society. Robert Hooke was born in 1635 in Freshwater on the Isle of Wight. At the age of thirteen, he became the apprentice to the portrait painter Peter Lely.

Soon, Hooke enrolled in the Westminster School, boarding in the house of the headmaster Richard Busby, who guided him to quick mastering of the first six books of Euclid’s

*Elements*. Hooke applied his knowledge of geometry and tried to design “flying machines”. He was also interested in music and learned to play the organ. In 1653, he entered Christ College in Oxford where he won a chorister’s place. He was lucky to meet the members of the “Oxford branch” of the “Invisible College” among whom were Robert

Boyle, John Wilkins, John Wallis, and Christopher Wren. The meetings of the College gave him a rich insight into science and scientific work. Beginning in 1655, he was an assistant to Robert Boyle, and constructed the air pump that was needed in Boyle's experiments. Soon, he started to work on an accurate clock essential for the determination of the longitude at sea. He ended up using springs instead of a pendulum in order to make the clock independent of its orientation. While working on designs for the balance springs of clocks, he invented the Boyle law that, in its general form states that the pressure and the volume of a gas are inversely proportional.

Due to the political turbulence in the late 1650s, several members of the "Invisible College" moved to London, where they established the Royal Society in 1662. Hooke was appointed to the position of Curator of Experiments position in the Society. Although it was hoped that the Society would be able to provide payment to Hooke, he was required to demonstrate 3 to four experiments in each meeting without any recompense. In 1663, he was allowed to become a fellow of the Society without paying the annual fees. Hooke secured his necessary income by accepting the appointment of Professor of Geometry at Gresham College, London, in 1665.

Hooke's first book *Micrographia* was published in 1665. The book contained beautiful pictures of objects Hooke had studied through a microscope he had made himself. Hooke was the first person to build a Gregorian reflecting telescope based on a parabolic mirror. With his telescope he observed the rotation of Jupiter and made drawings of Mars that were later used to determine its period of rotation. In 1666, he realized the possibility of measuring gravity with a pendulum and made measurements at different altitudes. The same year, he gave the talk *The system of the World* that appeared an important stimulus for Newton in his work for the Principia.

As a part of his work in optics, he investigated the phenomenon of refraction. He deduced the wave theory of light and was the first to suggest that matter expands when heated and that air is made of small particles separated by relatively large distances. He performed pioneering work in the field of surveying and map-making and was involved in the work that led to the first modern plan-form map, though his plan for London on a grid system was rejected in favor of rebuilding along the existing routes.

When Newton presented his corpuscular theory of light and colors, Hooke argued that anything that is correct in Newton's work, originates from Hooke's ideas from 1665. Hooke was bitter in finding out that Newton had taken the full honor of the law of gravitation without reference to his prior ideas. In fact, Hooke had not been the only one proposing the inverse square law of gravitation. Anyway, Newton was the one who was able to show its mathematical connection to elliptic orbits.

<http://www-history.mcs.st-andrews.ac.uk/Biographies/Hooke.html>

[http://en.wikipedia.org/wiki/Robert\\_Hooke](http://en.wikipedia.org/wiki/Robert_Hooke)

Allan Chapman, *England's Leonardo: Robert Hooke and the art of experiment in Restoration England*.

<http://www.roberthooke.org.uk/leonardo.htm>

Hooke, *Micrographia* (1664), <http://www.gutenberg.org/files/15491/15491-h/15491-h.htm>

## Isaac Newton (1643–1727)

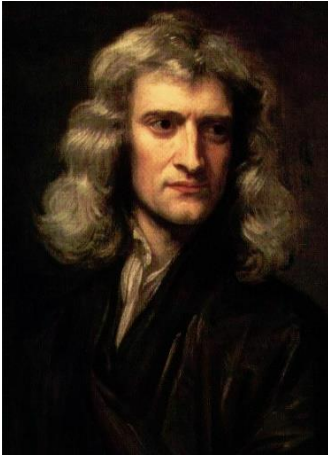

Isaac Newton was an English physicist, mathematician, astronomer, natural philosopher, alchemist and theologian, who was perhaps the greatest and most influential scientist who ever lived. Isaac Newton was born as the son of a prosperous farmer and landowner in the manor house of Woolsthorpe, near Grantham in Lincolnshire. His father died just before Isaac was born and his mother, Hannah Ayscough remarried Barnabas Smith, the minister of the church at North Witham, a nearby village, when Isaac was two years old. Isaac was left in the care of his grandmother.

Isaac's first school was the Free Grammar School in Grantham. He did not show major progress and was described as being passive and isolated. In 1659, his mother withdrew him from the school to enable him to manage her fortune; Isaac was not, however, interested in such a responsibility. Isaac's uncle, William Ayscough, persuaded his mother to send him back to school so that he might complete his education. Isaac lodged with Henry Stokes, the headmaster of the school. Stokes saw academic promise in Isaac's progress, and persuaded Isaac's mother to send him to Trinity College Cambridge.

In addition to Aristotle and Plato, Newton studied the philosophies of Descartes, Hobbes, and Boyle, as well as the celestial mechanics of Copernicus and Galilei, and Kepler's *Optics*. Newton's interest in mathematics may have been triggered by Isaac Barrow's edition of Euclid's *Elements* and Wallis's *Algebra*. Beginning in 1663, Newton's tutor in mathematics was Isaac Barrow, who had been working on the basis of integral and differential calculus. Newton graduated in 1665. In that summer the plague closed the University and he had to return to Lincolnshire. There, over the next two years, he began revolutionary advances in mathematics, optics, physics, and astronomy.

The University of Cambridge was reopened in 1667. Newton was elected to a minor fellowship at Trinity College but after being awarded his Master's Degree he was elected to a major fellowship in July 1668, which allowed him to dine at the Fellows' Table. In July 1669, Isaac Barrow tried to ensure that Newton's mathematical achievements became known to the world. He sent Newton's text *De Analysi* to his colleagues in London. Among the readers of the text was William Brouncker, an Irish mathematician, the chairman of the Royal Society. In that same year Newton was appointed, as Isaac Barrow's successor, to the Lucasian chair at Trinity College. Newton started his lectures with the properties of light and his view that the white color is the sum of all of the colors in the spectrum.

In 1672, Newton was elected a fellow of the Royal Society after donating a reflecting telescope. His first scientific publication was the treatise on the properties of light in the *Philosophical Transactions of the Royal Society*. Hooke and Huygens opposed

Newton's corpuscular approach in favor of the wave model – Newton first published his book *Optics* after Hooke's death in 1704.

There was also a dispute between Newton and Hooke concerning the originality of inverse square law of gravitation. Hooke had assumed the law, but Newton found the mathematical proof as a part of his solution of the orbits of planets in celestial mechanics.

In his main work, *Philosophiæ Naturalis Principia Mathematica* (*Mathematical Principles of Natural Philosophy*), published in 1687, Newton defines the basis of classical mechanics, and solves the physical and mathematical bases of the Keplerian orbits.

Newton's work was an unambiguous proof of the Copernican solar system and it marked the beginning of a scientific revolution.

The significance of Newton's role as the pioneer of mathematical physics can hardly be overestimated. However, it is worth noting the prior work on the calculus and the basic principles of the laws of motion and gravitation: the Copernican system, Kepler's orbits and laws, Galilei's findings on accelerating motion and the relativity principle, René Descartes's concept of the laws of motion, the conservation laws and the momentum, Christiaan Huygens's centrifugal force and the solution of pendulum, and the bases of calculus by Pierre de Fermat and John Wallis.

Newton's work meant a breakthrough of empiricism. In the *Principia*, Newton wanted to base his conclusions on observations and to accept the observed facts as such rather than as consequences of hypotheses. Newton did not, however, deny the order and law in nature. The metaphysical basis in his thinking is reflected in the General Scholium at the end of the *Principia*<sup>1</sup>: *"This most elegant system of the Sun, planets, and comets could not have arisen without the design and dominion of an intelligent and powerful being. And if the fixed stars are similar systems, they will all be constructed according to a similar design and subject to the dominion of One, especially since light of the fixed stars is of the same nature as the light from the sun, and all the systems send light to each others. And so that the systems of fixed stars will not fall upon one another as a result of their gravity, he has placed them at immense distances from one another"*.

Newton saw God as one and the same God always and everywhere, *"omnipresent not only virtually but also substantially; for action requires substance"*.

<http://plato.stanford.edu/entries/newton/>

<http://www-history.mcs.st-andrews.ac.uk/Biographies/Newton.html>

[http://en.wikipedia.org/wiki/Isaac\\_Newton](http://en.wikipedia.org/wiki/Isaac_Newton)

<http://plato.stanford.edu/entries/newton-principia/>

*Philosophiæ naturalis principia mathematica* (Latin) [openlibrary.org](https://openlibrary.org)

*Principia* (in English), [openlibrary.org](https://openlibrary.org)

Newton, *Descartes, Space, and Body*, <http://www.earlymoderntexts.com/assets/pdfs/newton1666.pdf>

Newton, *A New Theory of Light and Colour*, <http://www.earlymoderntexts.com/assets/pdfs/newton1671.pdf>

Newton, *Arithmetica Universalis*, <http://archive.org/stream/arithmetica01newtuoft> (Latin)

Newton, *Optics: or a Treatise of the reflections, refractions, inflexions and colours of Light*, [google book](https://books.google.com/books?id=...),

<http://www.rarebookroom.org/Control/nwtopt/index.html> ,

David Brewster, *The life of sir Isaac Newton*, [openlibrary.org](https://openlibrary.org)

<sup>1</sup> Newton, *Principia*, third edition (1726), A new translation by I. Bernard Cohen and Anne Whitman, p. 940.

## Ole Rømer (1644–1710)



Ole Rømer was a Danish astronomer who is best known for his measurements of Jupiter's Io moon for determining the velocity of light in 1676. Rømer was born in Århus on the east side of the peninsula of Jutland in Denmark. He studied at the University of Copenhagen; after his studies he worked in the *Uraniborg observatory* originally built for Tycho Brahe on the island of Hven, near Copenhagen. His famous measurement of the phases of the Io moon of Jupiter occurred at the Uraniborg observatory.

Rømer worked for some years in France taking part in the design of the famous fountains in Versailles. In Paris, as the assistant of Giovanni Cassini, he continued the observations of the periods of the moon Io. Rømer returned to Denmark in 1681, and was appointed royal mathematician and as a professor of astronomy at the University of Copenhagen. He worked on the development of navigation techniques and the system for weights and measures. One of his standards served as the basis for the Fahrenheit temperature scale.

<http://galileo.rice.edu/Catalog/NewFiles/roemer.html>

[http://en.wikipedia.org/wiki/Ole\\_R%C3%B6mer](http://en.wikipedia.org/wiki/Ole_R%C3%B6mer)

## Gottfried Leibniz (1646–1716)



Gottfried Leibniz was a German philosopher, mathematician, and physicist. He was born in Leipzig in the Free State of Saxony in the southeastern part of modern Germany.

Gottfried's father died when he was only six years old and he was brought up by his mother. Obviously, Leibniz learnt his moral and religious values from his mother, which would play an important role in his life and philosophy. Importantly, he inherited his father's large library. His father, Friedrich Leibniz, had been the professor of moral philosophy at the University of Leipzig.

At the age of seven, Leibniz entered the Nicolai School in Leipzig. Although he was taught Latin at school, Leibniz had taught himself far more advanced Latin and some Greek by the age of 12. He seems to have been motivated by wanting to read his father's books. In particular, he read books on metaphysics, and theology books from both Catholic and Protestant writers.

At the age of fourteen, Gottfried Leibniz entered the University of Leipzig. He studied philosophy and mathematics and graduated with a bachelor's degree in 1663 at the age of seventeen. He continued his studies towards a doctorate in law and was ready for his dissertation in 1666. However, he was refused the doctorate in law at Leipzig, maybe due to his youth. To avoid delays, he went to the University of Altdorf where he received a doctorate in law in February 1667 for his dissertation *De*

*Casibus Perplexis* (On Perplexing Cases). In 1669, Leibniz was appointed Assessor in the Court of Appeal, followed by a diplomatic role in Paris.

In Paris, Leibniz had the opportunity to meet Christiaan Huygens, who inspired him to become acquainted with mathematics and physics. He studied the works of René Descartes and Blaise Pascal and reached quickly his tutors' level, developing further their ideas, and introducing his version of the differential and integral calculus.

In his writings *Theoria motus abstracti* (1671) and *Theoria motus concreti* Leibniz tries to formulate the laws of motion starting from Hobbes's "conatus". The result, however, was not satisfactory.

In 1676, Leibniz realized the problem in Descartes's momentum and the conservation of momentum. Based on Galileo Galilei's experiments with falling objects, Leibniz concluded that the conservation of momentum infringes Aristotle's *entelecheia*, the actualization of potentiality, or cause and effect. For a falling object, the cause of the motion and the living force (*vis viva*) obtained is the dead force (*vis mortua*) released.

Leibniz's approach to physical phenomena emphasized the metaphysical basis. By paying attention to the origin of motion he, unlike Descartes and Newton, recognized the quantity of energy,  $mv^2$  (*vis viva* – living force), instead of the momentum,  $mv$ .

The concepts of *vis viva* and *vis mortua* suggest that Leibniz's intuition revealed the principle of the conservation of energy. An object needs the presence of a dead force in order to convert it into living force, such as the tension in a rope of a sling or the gravitational potential as altitude. In modern terms this means that the kinetic energy of an object is gained against the release of potential energy.

As a philosopher, Leibniz is generally seen as one of the 17th century rationalists like René Descartes and Baruch Spinoza. Although the first cause is an important element in Leibniz's rational natural philosophy, he also based his conclusions on experiments, as is seen from his way of showing the conservation of the living force (*vis viva*) in a pendulum and in fall and lift. Leibniz's empirical orientation is also reflected by his engineering work with mechanical calculators.

In Leibniz's metaphysics, a central attribute of "real philosophy" is the existence of an underlying substance; Leibniz is looking for "simple substance" that has will and



Leibniz's mechanical calculator in 1673. Although the basic construction was inherited from Pascal, Leibniz's machine was the first that was able to perform all four arithmetic operations: addition, subtraction, multiplication and division.

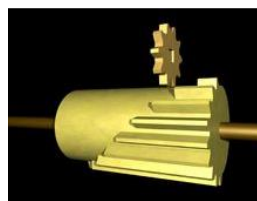

The Leibniz wheel (below) was still used in the first mechanical calculators in mass production.

consciousness. In his monadology<sup>1</sup>, Leibniz applied his concept of substance to material bodies by describing the elementary parts of matter as monads – “perpetual living mirrors of the universe” (or the rest of mass in the universe) that conserve their connection to all matter, in a certain similarity to Anaxagoras’s *Nous* as the underlying principle of matter.

This kind of concept of matter may have been one argument in Leibniz’s critique of Newton’s gravitation between separate isolated atoms and any material bodies composed of atoms. The difference between an “isolated” atom and a “monadic” atom is that the latter maintains the connection, via the gravitational potential, to the rest of matter in space.

In 1676, Leibniz settled in Hannover, where he was promoted to Privy Counselor of Justice, a post he held for the rest of his life. He continued travelling and working on the development of integral and differential calculus. In 1684, he published the treatise *Nova Methodus pro Maximis et Minimis, itemque Tangentibus* containing rules and tables of derivatives, and two years later a treatise on integration. In these publications he introduced the notations that remain as standard in mathematics. Leibniz’s mathematical achievements also include, for example, the theory of binary numbers and the use of determinants for solving simultaneous equations.

Leibniz was one of the most productive and wide-ranging natural philosophers and polymaths of all time. In 1710, he published the philosophical work *Théodicée* that discussed the essence of evil in a world created by a good God. His famous *Monadologia* was published in 1714.

The last years of Leibniz were shadowed by the accusation of plagiarism of Newton’s integral calculus. This accusation was actively pursued by Newton’s colleagues in the Royal Society. According to present understanding Leibniz and Newton developed calculus independently, but they certainly had roots in common in their developments. Leibniz died in Hannover on the 14<sup>th</sup> of November in 1716; his grave went unmarked for more than 50 years.

<http://www-history.mcs.st-and.ac.uk/Biographies/Leibniz.html>

<http://www.science.uva.nl/~seop/entries/leibniz/>

<http://en.wikipedia.org/wiki/Leibniz>

*Leibniz’s correspondence with Arnauld* (1686–7): <http://www.earlymoderntexts.com/authors/leibniz>

*Leibniz’s exchange of views with Pierre Bayle* (1697–1702): <http://www.earlymoderntexts.com/assets/pdfs/leibniz1697a.pdf>

*New Essays on Human Understanding* (1705): <http://www.earlymoderntexts.com/authors/leibniz>

*Leibniz’s exchange of papers with Clarke* (1715–16): <http://www.earlymoderntexts.com/assets/pdfs/leibniz1715.pdf>

*Freedom and possibility* (1680): <http://www.earlymoderntexts.com/assets/pdfs/leibniz1680.pdf>

*Meditations on knowledge, truth, and ideas* (1684): <http://www.earlymoderntexts.com/assets/pdfs/leibniz1684.pdf>

*Contingency* (1686): <http://www.earlymoderntexts.com/assets/pdfs/leibniz1686b.pdf>

*First truths* (1686): <http://www.earlymoderntexts.com/assets/pdfs/leibniz1686c.pdf>

*Discourse on metaphysics* (1686): <http://www.earlymoderntexts.com/assets/pdfs/leibniz1686d.pdf>

*Real-life dialogue on human freedom and the origin of evil* (1695): <http://www.earlymoderntexts.com/assets/pdfs/leibniz1695a.pdf>

*Essay on dynamics* (1695): <http://www.earlymoderntexts.com/assets/pdfs/leibniz1695b.pdf>

*New system* (1695): <http://www.earlymoderntexts.com/assets/pdfs/leibniz1695c.pdf>

*The ultimate origin of things* (1697): <http://www.earlymoderntexts.com/assets/pdfs/leibniz1697b.pdf>

*Nature itself* (1698): <http://www.earlymoderntexts.com/assets/pdfs/leibniz1698.pdf>



*Making the case for God* (1710): <http://www.earlymoderntexts.com/assets/pdfs/leibniz1710.pdf>  
*Principles of nature and grace* (1714): <http://www.earlymoderntexts.com/assets/pdfs/leibniz1714a.pdf>  
*Monadology* (1714): <http://www.earlymoderntexts.com/assets/pdfs/leibniz1714b.pdf>  
*An Examination of the Claims of Leibniz and Newton to the Invention of the Analysis of Infinites*,  
[https://en.wikipedia.org/wiki/Leibniz%E2%80%93Newton\\_calculus\\_controversy](https://en.wikipedia.org/wiki/Leibniz%E2%80%93Newton_calculus_controversy)  
 Leibniz, e-books [openlibrary.org](http://openlibrary.org)

## Edmond Halley (1656–1742)



Edmond Halley was an English astronomer, geophysicist, mathematician, meteorologist, and physicist who is best known for computing the orbit of the eponymous Halley's Comet. Halley was born in Hagerston, in the London area in England. As a child, he was very interested in mathematics and studied at St. Paul's School, and then, from 1673, at Queen's College, Oxford. In 1676, Halley visited the island of Saint Helena in the south Atlantic and set up an observatory with a large sextant with telescopic sights to catalogue the stars of the southern hemisphere. The results from his observations on St. Helena were published as *Catalogus Stellarum Australium* and included 341 southern stars. In a second paper he presented a chart on trade winds and monsoons. In this paper, he identified solar heating as the cause of atmospheric motions. He also established the relationship between barometric pressure and height above sea level.

In 1705, applying historical astronomical methods, he published *Synopsis Astronomiae Cometiciae*, which stated his belief that the comet sightings of 1456, 1531, 1607, and 1682 related to the same comet, which he predicted would return in 1758. Halley did not live to witness the comet's return, but when it did, the comet became generally known as Halley's Comet.

Halley studied inhomogeneities in Earth's magnetic field and published a map for the variations of the compass at sea, *General Chart of the Variation of the Compass* (1701). For explaining the variations, he put forth the idea of a hollow Earth consisting of a shell about 500 miles (800 km) thick, two inner concentric shells and an innermost core, about the diameters of the planets Venus, Mars, and Mercury. He suggested that atmospheres separated these shells, and that each shell had its own magnetic poles, with each sphere rotating at a different speed.

Halley studied inhomogeneities in Earth's magnetic field and published a map for the variations of the compass at sea, *General Chart of the Variation of the Compass* (1701). For explaining the variations, he put forth the idea of a hollow Earth consisting of a shell about 500 miles (800 km) thick, two inner concentric shells and an innermost core, about the diameters of the planets Venus, Mars, and Mercury. He suggested that atmospheres separated these shells, and that each shell had its own magnetic poles, with each sphere rotating at a different speed.

Halley had an important role in urging Newton to write the *Principia Mathematica*, and in paying the costs of publication.

<http://www-history.mcs.st-andrews.ac.uk/Biographies/Halley.html>

[http://en.wikipedia.org/wiki/Edmond\\_Halley](http://en.wikipedia.org/wiki/Edmond_Halley)

Edmond Halley, *Astronomical Tables with Precepts* (1752), [openlibrary.org](http://openlibrary.org)

## James Bradley (1693–1762)



James Bradley was an English astronomer who served as Astronomer Royal from 1742, succeeding Edmond Halley. In about 1730, Bradley recognized the difference between the effects of aberration and parallax. In fact, he discovered the aberration of light while attempting to detect stellar parallax. The theory of the aberration also gave Bradley a means of improving the accuracy of the previous estimate of the speed of light, which had previously been shown to be finite by the work of

Ole Rømer and others.

James Bradley's conclusions were based on accurate observations at a resolution of less than an arc second that he made with amateur astronomer Samuel Molyneux, who was also a member of parliament. As a side result of the aberration work, he discovered the nutation of the Earth's axis.

In his history of astronomy, published in 1821, the French mathematician and astronomer Jean Delambre rated Bradley, together with Hipparchus and Kepler as among the greatest astronomers of all times.

[http://en.wikipedia.org/wiki/James\\_Bradley](http://en.wikipedia.org/wiki/James_Bradley)

*Papers of James Bradley*, <http://janus.lib.cam.ac.uk/db/node.xsp?id=EAD%2FGBR%2F0180%2FERGO%203>

## Pierre Louis Maupertuis (1698–1759)



Pierre Louis Maupertuis was a French mathematician and philosopher, best known for the principle of least action. He is also known for his expeditions made for the measurement of the flatness of the Earth.

In the 1730s, the shape of the Earth became a flashpoint in the battle among rival systems of mechanics. Maupertuis, based on his exposition of Newton, predicted that the Earth should be oblate, while his rival Jacques Cassini, son of Giovanni Cassini, measured it astronomically to be prolate.

Maupertuis led an expedition to Lapland to measure the length of a degree of arc of the meridian for solving the problem. His results supported the oblate Earth, which settled the controversy in his favor.

After the Lapland expedition, Maupertuis completed his earlier mathematical work on the principle of least action that he saw as a metaphysical principle that underlies all the laws of mechanics. Maupertuis's principle of least action was a generalization of Pierre de Fermat's *principle of least time* applied to the propagation of light.

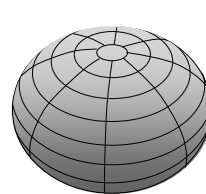

Maupertuis' Earth

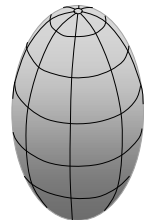

Cassini's Earth

<http://www-history.mcs.st-andrews.ac.uk/Biographies/Maupertuis.html>

[http://en.wikipedia.org/wiki/Pierre\\_Louis\\_Maupertuis](http://en.wikipedia.org/wiki/Pierre_Louis_Maupertuis)

*Essai de Cosmologie* (1751), [openlibrary.org](http://openlibrary.org)

## Daniel Bernoulli (1700–1782)



Daniel Bernoulli was a Swiss mathematician and physicist; he was one of the many prominent mathematicians in the Bernoulli family. He was born in Groningen, in the Netherlands, into a family of distinguished mathematicians. He was a close friend and colleague to Leonhard Euler while they worked in Saint Petersburg in 1727–33.

Bernoulli also wrote a large number of papers on various mechanical questions, especially on problems connected with vibrating strings. He showed that movements of strings of musical instruments are composed of an infinite number of harmonic vibrations all superimposed on the string.

His chief work is *Hydrodynamica* (*Hydrodynamique*), published in 1738. In the book he, among other things, discusses the kinetic theory of gases starting from Boyle's law. *Hydrodynamique* resembles Joseph Louis Lagrange's *Mécanique Analytique* in being arranged so that all the results are consequences of a single principle, namely, the conservation of energy.

He is the earliest writer who attempted to formulate a kinetic theory of gases, and he applied the idea to explain Boyle's law.

[http://www-history.mcs.st-and.ac.uk/Biographies/Bernoulli\\_Daniel.html](http://www-history.mcs.st-and.ac.uk/Biographies/Bernoulli_Daniel.html)

[http://en.wikipedia.org/wiki/Daniel\\_Bernoulli](http://en.wikipedia.org/wiki/Daniel_Bernoulli)

## Benjamin Franklin (1706–1790)



Benjamin Franklin was one of the Founding Fathers of the United States. He was a polymath, a leading author, printer, political theorist, politician, postmaster, scientist, musician, inventor, satirist, civic activist, statesman, and diplomat.

Benjamin Franklin was born in Boston, but spent most of his life in Philadelphia. He was mainly self-educated, aided by the convenient access to books provided by an apprenticeship in the printing business. Benjamin Franklin is perhaps best known for his experiments and inventions related to electricity. His liberal view of life was reflected in his attitude toward inventions: “... as we enjoy great advantages from the inventions of others, we should be glad of an opportunity to serve others by any invention of ours; and this we should do freely and generously [*Autobiography*]”.

Franklin established the *American Philosophical Society* in 1743. Together with *Leonhard Euler*, he was one of the few supporters of the wave theory of light presented by *Christiaan Huygens*.

In Franklin's, time electricity was mainly considered as a fluid. He was the first to name positive and negative charges, and the first to suggest the principle of conservation of charge. He realized that lightning is electricity. In 1750, he proposed an experiment to prove that lightning is electricity by flying a kite in a storm that appeared capable of becoming a lightning storm. Results of his apocryphal experiments with kites have not been documented. Anyway, Franklin noted that conductors with a sharp rather than a smooth point were more effective in discharging electricity, which led to his invention of the lightning rod.

[http://www-history.mcs.st-andrews.ac.uk/Biographies/Franklin\\_Benjamin.html](http://www-history.mcs.st-andrews.ac.uk/Biographies/Franklin_Benjamin.html)

[http://en.wikipedia.org/wiki/Benjamin\\_Franklin](http://en.wikipedia.org/wiki/Benjamin_Franklin)

*Benjamin Franklin's publications*, [wikisource.org](http://wikisource.org)

## Leonhard Euler (1707–1783)



Leonhard Euler was a Swiss mathematician and physicist, one of the top mathematicians of all time. Euler was born in Basel in Switzerland. His father, Paul Euler, was a friend of the Bernoulli family, famous for many competent mathematicians. At the age of thirteen Leonhard enrolled at the University of Basel and, in 1723, received his Master of Philosophy with a dissertation that compared the philosophies of Descartes and Newton. Euler spent most of his adult life in St. Petersburg, Russia, and in Berlin, Prussia.

Euler made numerous findings important to the forthcoming development of mathematics. He introduced the concept of a *function* and was the first to write  $f(x)$  to denote the function  $f$  applied to the argument  $x$ . He also introduced the modern notation for the trigonometric functions, the letter  $e$  for the base of the natural logarithm, the Greek letter  $\Sigma$  for summations and the letter  $i$  to denote the imaginary unit. Perhaps the best known of Euler's findings is "Euler's formula", which states that the complex exponential function satisfies the equation  $e^{i\varphi} = \cos \varphi + i \sin \varphi$ .

Euler worked in almost all areas of mathematics: geometry, infinitesimal calculus, trigonometry, algebra, and number theory – as well as continuum physics, lunar theory and other areas of physics. In mechanics, he, for example, influenced the development of Lagrange's analytical mechanics. Euler's works in the 1740s supported the wave description of light.

<http://www-history.mcs.st-and.ac.uk/Biographies/Euler.html>

[http://en.wikipedia.org/wiki/Leonard\\_Euler](http://en.wikipedia.org/wiki/Leonard_Euler)

*Kinetic Theories of Gravitation* (1760), [wikisource.org](http://wikisource.org)

V. F. Riskey, *A Reader's Guide to Euler's Introduction*, <http://fredrickey.info/hm/Euler-Introductio.pdf>

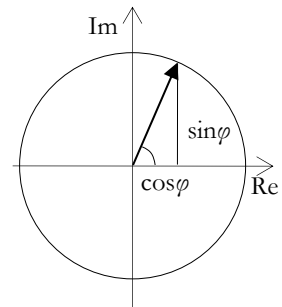

## Jean le Rond d'Alembert (1717–1783)



Jean le Rond d'Alembert was a French mathematician, mechanician, physicist, philosopher, and music theorist. He was also co-editor with Denis Diderot of the *Encyclopédie, ou dictionnaire raisonné des sciences, des arts et des métiers*. Jean le Rond d'Alembert was born in Paris as the illegitimate child of the writer Claudine Guérin de Tencin and the chevalier Louis-Camus Destouches, an artillery officer. Destouches was abroad at the time of d'Alembert's birth, and a couple of days after the birth his mother left him on the steps of the Saint-Jean-le-Rond de Paris church. According to custom, he was named after the patron saint of the church. Jean le Rond was adopted by the wife of a glazier. Destouches secretly paid for the education of Jean le Rond but did not want his paternity officially recognized. Jean le Rond d'Alembert studied philosophy, law, and arts. He became interested in mathematics, and in 1740, he published a treatise on flow dynamics and explained the refraction of light at an optical boundary.

His best-known work, *Traité de dynamique (Treatise on Dynamics)*, discusses Newton's mechanics. In the preface he explains that "*Rational mechanics was a science based on simple necessary principles from which all particular phenomena could be deduced by rigorous mathematical methods... mechanics should be made into a completely rationalistic mathematical system*". Also, he states that "*The internal forces of inertia are equal and opposite to the forces generating the acceleration*", known as the d'Alembert's principle. In general Jean le Rond d'Alembert is best known for his solutions of the wave equations.

<http://www-history.mcs.st-and.ac.uk/Biographies/D%27Alembert.html>

[http://en.wikipedia.org/wiki/Jean\\_le\\_Rond\\_d%27Alembert](http://en.wikipedia.org/wiki/Jean_le_Rond_d%27Alembert)

Links to d'Alembert's publications, [wikisource.org](http://www.wikisource.org), e-books [openlibrary.org](http://openlibrary.org)

<http://www.manhattanrarebooks-science.com/dalembert.htm>

## Immanuel Kant (1724–1804)



Immanuel Kant was a German philosopher from Königsberg (today Kaliningrad of Russia), who researched, lectured, and wrote on philosophy and anthropology.

In his *Metaphysics*, *Metaphysical Foundations of Natural Science*, Kant defines material things as those, and only those being able to move in space. Motion occurs in *absolute space at rest*. According to Kant, time and space are not materially real but merely the ideal a priori condition of our internal intuition. Motion is discussed in four Chapters of his metaphysics book: *Phoronomy, Dynamics, Mechanics and Phenomenology*.

Immanuel Kant may be the first who has proposed the *Nebular hypothesis*, according to which the Sun, the planets, and even the galaxies are formed from a large cloud of gas, a nebula. The idea was revolutionary; generally, the solar system and the

whole system of fixed stars had been considered as creations of God from the beginning – exceptions in such thinking had been presented by, for example, Tycho Brahe and Kepler.

<http://www.science.uva.nl/~seop/entries/kant/>

[http://en.wikipedia.org/wiki/Immanuel\\_Kant](http://en.wikipedia.org/wiki/Immanuel_Kant)

*Metaphysics*, <http://www.iep.utm.edu/kantmeta/>

*Critique of Pure Reason (to end of Analytic)* (1781 and 1787): <http://www.earlymoderntexts.com/authors/kant>

*Critique of Pure Reason (Dialectic)* (1781 and 1787): <http://www.earlymoderntexts.com/authors/kant>

*Prolegomena to any Future Metaphysic* (1783): <http://www.earlymoderntexts.com/assets/pdfs/kant1783.pdf>

*Groundwork for the Metaphysic of Morals* (1785): <http://www.earlymoderntexts.com/assets/pdfs/kant1785.pdf>

*Metaphysical Foundations of Natural Science* (1786): <http://www.earlymoderntexts.com/assets/pdfs/kant1786.pdf>

*Toward Perpetual Peace* (1795): <http://www.earlymoderntexts.com/assets/pdfs/kant1795.pdf>

*Kant's publications*, [wikisource.org](http://wikisource.org), e-books, [openlibrary.org](http://openlibrary.org)

## Henry Cavendish (1731–1810)



Henry Cavendish was British natural philosopher, scientist, and an important experimental and theoretical chemist and physicist. He is best known for his studies on the composition of air, a mechanical equivalent of heat, and experiments for determining the gravitational constant and the mass density of the Earth.

Henry Cavendish was born in Nice, France, where his family was living at the time. At age of 18 he entered the University of Cambridge, St. Peter's College, where he studied for three years. Before becoming a member, he was able to participate in the meeting of the Royal Society with his father Lord Charles Cavendish, who was a member.

Cavendish's determination of the gravitational constant was based on the attraction between lead balls. His estimate for the gravitational constant was  $G = 6.754 \cdot 10^{-11} \text{ Nm}^2/\text{kg}^2$  (the current CODATA value is  $G = 6.7428 \cdot 10^{-11} \text{ Nm}^2/\text{kg}^2$ ).

Henry Cavendish studied electricity, and demonstrated, for example, that the intensity of electric force was inversely proportional to the square of the distance. In mid-1800s, James Maxwell found Cavendish's notes defining the electrical potential, the dielectric constant, capacitance, and what are now known as Ohm's law and Coulomb's law. In 1879, Maxwell published Cavendish's notes in a 454 page book *The Electrical Researches of the Honourable Henry Cavendish, F.R.S.*

[http://en.wikipedia.org/wiki/Henry\\_Cavendish](http://en.wikipedia.org/wiki/Henry_Cavendish)

H. Cavendish, *The Electrical Researches.*, [openlibrary.org](http://openlibrary.org)

H. Cavendish, Scientific papers, Volume I, *The Electrical Researches*, by J.C. Maxwell (1921), [openlibrary.org](http://openlibrary.org)

H. Cavendish, Scientific papers, Volume II, *Chemical and Dynamical*, by E. Thorpe (1921), [openlibrary.org](http://openlibrary.org)

H. Cavendish, *Experiments on air*, [openlibrary.org](http://openlibrary.org)

## Joseph Priestley (1733–1804)



Joseph Priestley was an English theologian, natural philosopher, chemist, educator, political theorist and dissenting clergyman, who published over 150 works. He is mainly known, with Antoine Lavoisier, as the discoverer of oxygen. Priestley, unlike Lavoisier, continued to defend the phlogiston theory.

Priestley's science was integral to his theology, and he consistently tried to fuse Enlightenment rationalism with Christian theism. In his metaphysical texts, Priestley attempted to combine theism, materialism, and determinism. He believed that a proper understanding of the natural world would promote human progress and eventually bring about the Christian Millennium.

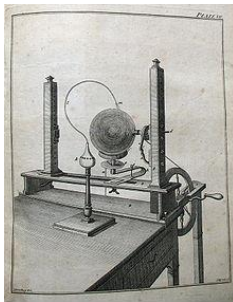

Priestley's "electrical machine for amateur experimentalists", illustrated in the first edition of his *Familiar Introduction to the Study of Electricity* (1768). Picture: *Wikimedia Commons*.

[http://en.wikipedia.org/wiki/Joseph\\_Priestley](http://en.wikipedia.org/wiki/Joseph_Priestley)

Popular Science Monthly Volume 6 November 1874,

Joseph Priestley by T.H. Huxley, [wikisource.org](http://wikisource.org)

J. Priestley, e-books, [openlibrary.org](http://openlibrary.org)

## Joseph Louis Lagrange (1736–1813)



Joseph Lagrange was a French mathematician and astronomer born in Turin, in northwestern Italy. Lagrange received his basic education at the college of Turin. He became a mathematician mainly through his own activity and interest triggered by Edmond Halley's 1693 work on the use of algebra in optics. Joseph Lagrange lived part of his life in Prussia and part in France.

In mathematics, Lagrange made major contributions to the basis of group theory and the calculus of variations.

In celestial mechanics he is known for the Lagrangian points, the five positions in an orbital configuration where a small object affected only by gravity can theoretically be part of a constant-shape pattern with two larger objects (such as a spacecraft with respect to the Sun and the Earth). Lagrange is best known for Lagrangian mechanics, which is a re-formulation of classical Newtonian mechanics. In Lagrangian mechanics, a system is described in an optimized coordinate system, determined by the number of the degrees of freedom.

In his book *Mécanique Analytique*, Joseph Lagrange discusses widely Newtonian mechanics, and develops it into a formalism expressed in terms of differential equations. In the preface of the book he states: “*One will not find figures in this work. The methods that I expound require neither constructions, nor geometrical or mechanical arguments, but only algebraic operations, subject to a regular and uniform course.*”

*École Polytechnique* was founded in 1794; Lagrange was its first professor of analysis, giving courses on elementary mathematics. He was highly respected, but it was said that his lectures were far too abstract for the students.

<http://www-history.mcs.st-and.ac.uk/Biographies/Lagrange.html>

[http://en.wikipedia.org/wiki/Joseph\\_Lagrange](http://en.wikipedia.org/wiki/Joseph_Lagrange)

Joseph Lagrange, original papers [http://sites.mathdoc.fr/cgi-bin/oetoc?id=OE\\_LAGRANGE\\_11](http://sites.mathdoc.fr/cgi-bin/oetoc?id=OE_LAGRANGE_11)

*Mécanique Analytique*, [openlibrary.org](http://openlibrary.org)

Joseph Lagrange, *Lectures on elementary mathematics*, [openlibrary.org](http://openlibrary.org)

## Charles-Augustin de Coulomb (1736–1806)



Charles Coulomb was a French physicist, who is best known for developing Coulomb’s law, the definition of the electrostatic force of attraction and repulsion in 1785.

In order to measure the *Coulomb force*, Charles Coulomb first analyzed the properties of a torsion balance, and then applied the balance for the measurement of the repulsive force between metal balls with similar electrical charges. The properties of the torsion balance and the results he obtained with the charged ball he described as follows: “*The moment of the torque is, for wires of the same metal, proportional to the torsional angle and the fourth power of the diameter, and the inverse of the length of the wire.*”

In 1785, Coulomb presented his three reports on electricity and magnetism, *Premier Mémoire sur l’Électricité et le Magnétisme*, which describes the results of the measurement of the force between metal balls charged with “the same kind” of electricity: “*It follows therefore from these three tests, that the repulsive force that the two balls – electrified with the same kind of electricity – exert on each other, follows the inverse proportion of the square of the distance.*”

In the case of opposite charges, he states: “*The attractive force between two oppositely charged spheres is proportional to the product of the quantities of charge on the spheres and is inversely proportional to the square of the distance between the spheres.*”

Charles Coulomb made similar observations with magnets. He did not, however, observe the connection between electricity and magnetism.

<http://www-history.mcs.st-and.ac.uk/Biographies/Coulomb.html>

[http://en.wikipedia.org/wiki/Charles-Augustin\\_de\\_Coulomb](http://en.wikipedia.org/wiki/Charles-Augustin_de_Coulomb)

Vier Abhandlungen über die Elektrizität und den Magnetismus, [openlibrary.org](http://openlibrary.org)



## William Herschel (1738–1822)



William Herschel was a German-born British astronomer, technical expert, and composer born in Hanover, Germany. Herschel followed his father into the Military Band of Hanover, before emigrating to Britain at age 19. He is best known for his reflecting telescopes and the discovery of planet Uranus, along with two of its major moons, Titan and Oberon.

Also, Herschel discovered two moons of Saturn. He was the first person to discover the existence of infrared radiation.

[http://en.wikipedia.org/wiki/William\\_Herschel](http://en.wikipedia.org/wiki/William_Herschel)

*William Herschel and his work* by James Sime (1900), [wikisource.org](#), [openlibrary.org](#)

*The Herschels and modern astronomy*, Agnes M. Clerke (1895), [openlibrary.org](#)

*Preliminary Discourse of the Study of Natural Philosophy* by Sir J.F.W. Herschel, [openlibrary.org](#)

## Antoine Lavoisier (1743–1794)



The French chemist Antoine Lavoisier, born in Paris, is known as the “father of modern chemistry”.

Lavoisier’s researches included some of the first truly quantitative chemical experiments. He carefully weighed the reactants and products in a chemical reaction, which was a crucial step in the advancement of chemistry. He showed that, although matter can change its state in a chemical reaction, the total mass of matter is the same at the end as at the beginning of every chemical change.

Lavoisier realized that combustion is a chemical reaction between oxygen and the burning material, thus invalidating the phlogiston theory. He demonstrated the role of oxygen in the rusting of metal, as well as oxygen’s role in animal and plant respiration.

Lavoisier had received a law degree, and at the age of 26 he obtained a position as a tax collector, with fatal results. Although he was one of the few liberals in his position, all tax collectors were executed during the French Revolution. Lavoisier was tried, convicted, and guillotined on 8 May 1794 in Paris, at the age of 50.

Lagrange said on the death of Lavoisier: “*It took only a moment to cause this head to fall and a hundred years will not suffice to produce its like*”.

Lavoisier’s book *Traité Élémentaire de Chimie (Foundations of Chemistry)*, published in 1789 has been considered the first book on modern chemistry.

[http://en.wikipedia.org/wiki/Antoine\\_Lavoisier](http://en.wikipedia.org/wiki/Antoine_Lavoisier)

Antoine Lavoisier, *Traité élémentaire de chimie* (1789), [openlibrary.org](#)

Antoine Lavoisier, *Elements of Chemistry: In a New Systematic Order* (1799), [openlibrary.org](#)

## Alessandro Volta (1745–1827)



Alessandro Volta, born in Como, Italy, was an Italian physicist best known for the invention of the battery.

In 1774, Volta became a physics professor at the Royal School in Como and five years later the professor of experimental physics at the University of Pavia.

Volta observed that an electrical voltage was generated between different types of metals dipped into an electrolyte. The best combination of two metals was zinc and silver or zinc and copper. In his first cells the electrolyte was sulfuric acid. A battery was made of a pile of zinc-copper cells.

[http://en.wikipedia.org/wiki/Alessandro\\_Volta](http://en.wikipedia.org/wiki/Alessandro_Volta)

*Untersuchungen über den Galvanismus, 1796 bis 1800* by Alessandro Volta (1900), [openlibrary.org](http://openlibrary.org)

## Jean Delambre (1749–1822)



Jean Delambre was a French mathematician and astronomer from Amiens in northern France. Jean Delambre was largely self-taught both in mathematics and in astronomy. In 1783 he became the assistant of his teacher in the Collège de France, astronomer Jérôme Lalande, who was collecting data for the third edition of his *Treatise of Astronomy* (*Traité d'astronomie*).

When Lalande presented Delambre's measurements in the French Academy of Sciences, Delambre had an opportunity to meet Laplace and hear his presentation of the mathematics Laplace had developed for solving planetary interactions on orbits. Delambre was very impressed and decided to make observations of the orbit of Uranus in order to verify Laplace's theoretical results. The work brought him the 1789 Academy Grand Prix "... to an astronomer of wisdom and fortitude, able to review 130 years of astronomical observations, assess their inadequacies, and extract their value."

In 1792, Delambre received the Academy Grand Prix a second time for his accurate tables for Jupiter, Saturn, Uranus, and the Moons of Jupiter.

Jean Delambre had an important role in the project that finally produced the first standard for a meter in 1799. When Delambre presented the first volume of the history of measurement of the Earth behind the definition one meter to Napoleon, the emperor said: "*Conquests will come and go but this work will endure*".

In 1809, Delambre repeated Römer's measurements for the determination of the velocity of light by observing Jupiter's Io moon. Delambre's estimate for the propagation time from the Sun to the Earth was 8 minutes 12 seconds, which is only 7 seconds below the current estimate 8 minutes 19 seconds.

In the last phase of his career Delambre became interested in the history of mathematics and astronomy. He stated that his aim was to produce “...a repository where could be found all the ideas, all the methods, and all the theorems that have served successively for the calculation of phenomena”.

<http://www-history.mcs.st-and.ac.uk/Biographies/Delambre.html>

[http://en.wikipedia.org/wiki/Jean\\_Delambre](http://en.wikipedia.org/wiki/Jean_Delambre)

Jean Delambre, e-books, [openlibrary.org](http://openlibrary.org).

## Pierre-Simon Laplace (1749–1827)



The French mathematician and astronomer Pierre-Simon Laplace is best known for his Laplace-transformation and Laplace-operator widely used in mathematical physics. Laplace made a major contribution to the refinement of Newtonian celestial mechanics with his mathematics for the calculation of planetary interactions.

Laplace was born in the city of Beaumont-en-Auge, Normandy, as the son of Pierre Laplace, a farmer involved in cider trade. After his primary school, Laplace entered the University of Caen to study theology, but in a couple of years, inspired by his teachers, he noticed his own great abilities and interest in mathematics. His teachers gave him a letter of introduction to Jean le Rond d'Alembert in Paris. Laplace's talents were quickly recognized, and with the support of d'Alembert Laplace was appointed as professor of mathematics at the École Militaire.

Laplace began producing remarkable mathematical papers, the first presented to the Académie des Sciences in Paris on 28 March 1770. Laplace's early papers dealt with the integral and differential calculus. As an extension of Adrien-Marie Legendre's associated Legendre functions, Laplace introduced the *spherical harmonics* that have high importance in modern physics. As a new approach to celestial mechanics, Laplace introduced the concept of the *scalar potential* that allows the replacement of a *vector field* with a scalar field that is both conceptually and computationally easier to deal with than a vector field. The potential function satisfies the differential equation referred to as Laplace's equation.

Laplace's best-known work on celestial mechanics is the solution of the planetary inequalities in 1780s. This dealt mainly with the identification and explanation of the perturbations now known as the “great Jupiter–Saturn inequality”. Also, he produced an analytical solution to a significant problem regarding the motion of the Moon.

Laplace thought about the possibility of an extreme mass concentration, a black hole that prevented the propagation of light when the escape velocity was higher than the velocity of light. Laplace also developed the idea of the possibility that the nebulae were distant galaxies comparable to the Milky Way. In his book *Exposition du système*

*du monde* (*The System of the World*) Laplace discusses also the possibility that the solar system has evolved from a globular mass of incandescent gas rotating around an axis through its center of mass.

Laplace still continued to develop the corpuscular theory of light when Fresnel presented the well-based wave theory in 1815.

Laplace made major advancements in statistical methods, the probability-generating function, and the method of least squares. Laplace's success in celestial mechanics may have influenced his ideas on extreme determinism, Laplace's demon, or causal or scientific determinism:

*"We may regard the present state of the universe as the effect of its past and the cause of its future. An intellect which at a certain moment would know all forces that set nature in motion, and all positions of all items of which nature is composed, if this intellect were also vast enough to submit these data to analysis, it would embrace in a single formula the movements of the greatest bodies of the universe and those of the tiniest atom; for such an intellect nothing would be uncertain and the future just like the past would be present before its eyes<sup>1</sup>"*

<http://www-history.mcs.st-and.ac.uk/Biographies/Laplace.html>

[http://en.wikipedia.org/wiki/Pierre-Simon\\_Laplace](http://en.wikipedia.org/wiki/Pierre-Simon_Laplace)

Pierre Simon Laplace, *A Philosophical Essay on Probabilities* (1814), [openlibrary.org](http://openlibrary.org)

The Mechanics of Laplace, [openlibrary.org](http://openlibrary.org)

Pierre Simon Laplace, *Elementary illustrations of the Celestial mechanics: Part 1*, [openlibrary.org](http://openlibrary.org)

Pierre Simon Laplace, *Mécanique Céleste*, (1827) English translation by N. Bowditch, <http://www.archive.org/stream/mcaniquecles01laprich#page/n7/mode/2up>

Pierre Simon Laplace, *The system of the world*, (1830), [openlibrary.org](http://openlibrary.org)

Pierre Simon Laplace, e-books, [openlibrary.org](http://openlibrary.org)

<sup>1</sup> Laplace, *A Philosophical Essay*, New York, 1902, p. 4

## Adrien-Marie Legendre (1752–1833)



Adrien-Marie Legendre was a French mathematician, who is best known for the *Legendre function* bearing his name. Adrien-Marie Legendre was born in Paris or Toulouse into a wealthy family.

In 1775–1780, Legendre, as a colleague of Pierre-Simon Laplace, taught mathematics in *École Militaire*. His career was promoted by the 1782 prize on projectiles offered by the Berlin Academy. As his next subject, Legendre studied gravitation on an ellipsoid. The work, producing the Legendre functions, was highly praised by Laplace, and Legendre was appointed an adjoint membership in the French Academy of Sciences. In the next few years, Legendre published his works on celestial mechanics, number theory, elliptic functions, and the integration of elliptic curves. The publications also included an approximate proof of quadratic reciprocity that Gauss solved in detail at the age of only eighteen years.

In 1787, Legendre was nominated a full member of the Academy of Sciences, as a member of a group that, together with the Greenwich Royal Observatory, worked on measurements of the Earth involving a triangulation survey between the Paris

and the Greenwich observatories. In 1791, Legendre was nominated to the committee for the standardization of weights and measures. At that time he wrote his best known book, *Eléments de géométrie* (*Elements of Geometry*), published in 1794. Among other books by Legendre were *Exercices du Calcul Intégral* (*Excercises for the Calculation of Integrals*) and *Traité des Fonctions Elliptiques* (*Treatise on Elliptic Functions*) as well as the *Théorie des nombres* (*Number Theory*) that he enlarged several times.

<http://www-history.mcs.st-and.ac.uk/Biographies/Legendre.html>

[http://en.wikipedia.org/wiki/Adrien-Marie\\_Legendre](http://en.wikipedia.org/wiki/Adrien-Marie_Legendre)

Adrien-Marie Legendre, *Elements of Geometry and Trigonometry* (1839), [openlibrary.org](http://openlibrary.org)

Adrien-Marie Legendre, e-books, [openlibrary.org](http://openlibrary.org)

## John Dalton (1766–1844)



John Dalton was an English chemist, meteorologist and physicist, who is best known for his contribution to the early development of the atomic theory. He was born into a Quaker family in Eaglesfield, Cumberland, England.

Dalton's family belonged to the Quakers, a religious group somewhat isolated from society. Therefore, John Dalton received private education, mainly from a blind mathematician and natural philosopher, John Groughin, as well as from an experienced meteorologist and instrument maker Elihu Robinson. John Dalton's first publication, *Meteorological Observations and Essays* (1793), dealt with meteorology but also contained the seeds of several of his later discoveries.

In 1800, Dalton became a secretary of the Manchester Literary and Philosophical Society, and in the following year he orally presented an important series of papers, entitled *Experimental Essays* on the constitution of mixed gases. The papers contained, essentially, the *Gay-Lussac Laws*, presented by the French Chemist Joseph Gay-Lussac in 1802.

The most important work of Dalton was his study on the ratios of elements in chemical reactions, and his hypotheses of atoms and molecules. His atomic theory was published in his book *New System of Chemical Philosophy* in 1808.

Dalton was looking for simple laws of nature and regarded the “*rule of greatest simplicity*” as worthy of being a law of nature. Dalton's work was continued by his pupil James Joule.

[http://en.wikipedia.org/wiki/John\\_Dalton](http://en.wikipedia.org/wiki/John_Dalton)

John Dalton by J.P. Millington (1906), [openlibrary.org](http://openlibrary.org)

John Dalton, Dictionary of National Biography, 1885-1900, Volume 13, [wikisource.org](http://wikisource.org)

<sup>1</sup> *A New System of Chemical Philosophy*, Part I, second edition (1842), [openlibrary.org](http://openlibrary.org)

John Dalton, *Foundations of the Molecular Theory*, [openlibrary.org](http://openlibrary.org)

John Dalton, *Foundations of the Atomic Theory*, [openlibrary.org](http://openlibrary.org)

*John Dalton and the rise of modern chemistry* by Sir Henry E. Roscoe, [openlibrary.org](http://openlibrary.org)

## Joseph Fourier (1768–1830)



Joseph Fourier was a French mathematician and physicist best known for the Fourier transformation and the Fourier series and their applications to problems of heat transfer and vibrations.

His first schooling was at Pallais's school, run by the music master from the cathedral. In 1780, he proceeded to the École Royale Militaire of Auxerre where he soon, at the age of thirteen, became interested in mathematics. In 1794, Fourier was nominated to study at the École Normale in Paris, where he was taught by Lagrange and Laplace, among others.

Fourier's 1807 treatise *On the Propagation of Heat in Solid Bodies* was not very well received by a committee consisting of Lagrange, Laplace, Monge and Lacroix, who criticized the use of trigonometrical series – that later on, turned out as one of the most valuable contributions to mathematics in physics by Fourier.

<http://www-history.mcs.st-and.ac.uk/Biographies/Fourier.html>

[http://en.wikipedia.org/wiki/Joseph\\_Fourier](http://en.wikipedia.org/wiki/Joseph_Fourier)

Joseph Fourier, e-books, [openlibrary.org](http://openlibrary.org)

## Thomas Young (1773–1829)



Thomas Young was an English polymath scientist who is perhaps best known for deciphering Egyptian hieroglyphics. In addition to Egyptology, Thomas Young made major contributions in several branches of natural sciences via his works on light, energy, mechanics, physiology, languages and the harmony in music.

Thomas Young was the eldest son of a Quaker family in Milverton, Somerset, in the southwestern part of England. At the age of fourteen, Young had learned Greek and Latin and was acquainted with French, Italian, Hebrew, German, Chaldean, Syriac, Samaritan, Arabic, Persian, Turkish and Amharic.

Young began to study medicine in London in 1792. In 1795, he moved to Göttingen, Lower Saxony, Germany where he obtained the degree of Doctor of physics in 1796. In 1797, he entered Emmanuel College, Cambridge. In 1799, he established himself as a physician in London. Young published many of his first academic articles anonymously to protect his reputation as a physician.

In 1801, Young was appointed professor of natural philosophy at the Royal Institution. In two years, he delivered 91 lectures. In 1803, however, he resigned his professorship, fearing that its duties would interfere with his medical practice. His lectures held in the Royal Institution, *Course of Lectures on Natural Philosophy and Mechanical Arts* were published in 1807. In addition to the lectures, the publication contained his unpublished writings and a list of 20 000 titles of scientific papers since antiquity.

One of Thomas Young's most important scientific works was his wave theory of light in 1803. His theory was supported by his many experiments on interference, including the famous double-slit experiment re-awakened later by quantum mechanics. Young explained colors as waves with different wavelengths. Also, he explained that color perception is based on three kinds of nerve fibers in the retina.

Young's wave theory of light confirmed Huygens's theory presented in his *Treatise of Light*, published in 1678.

Thomas Young was probably the first to call Leibniz's *vis viva* "energy".

[http://en.wikipedia.org/wiki/Thomas\\_Young\\_%28scientist%29](http://en.wikipedia.org/wiki/Thomas_Young_%28scientist%29)

*A Course of Lectures on Natural Philosophy and the Mechanical Arts* (1845), [openlibrary.org](http://openlibrary.org)

*Miscellaneous Works of the Late Thomas Young*, edited by George Peacock (1855), [openlibrary.org](http://openlibrary.org)

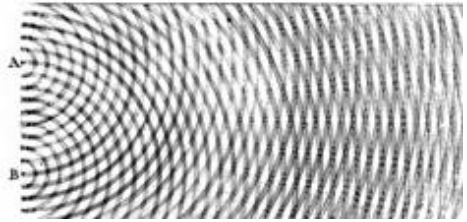

Thomas Young's sketch of double slit interference based on observations of water waves, Royal Society 1803. Picture, *Wikimedia Commons*.

## André-Marie Ampère (1775–1836)



André-Marie Ampère was a French physicist and mathematician from the Lyon area in France. He is best known for the unit of the electric current, the "ampere", named after him. Ampère is generally regarded as one of the main founders of the science of classical electromagnetism, which he referred to as "electrodynamics".

As an admirer of the philosophy of Jean-Jacques Rousseau, André-Marie's father believed that young boys should avoid formal schooling and pursue instead an "education direct from nature".

At the age of 12, Ampère became interested in mathematics and became acquainted with the works of Euler and Bernoulli. He widened his view by traveling and studying history, poetry, philosophy, and the natural sciences. André-Marie Ampère took his first regular job in 1799 as a mathematics teacher. He was appointed a professor of mathematics at École Polytechnique in 1809.

Ampère served as the professor of mathematics at École Polytechnique from 1809 to 1828. In addition to mathematics, Ampère was interested in metaphysics, physics, and chemistry. In 1815, he published an article on the refraction of light. He supported strongly the wave theory of Fresnel, and resisted the corpuscular theories of Laplace and Biot. Fresnel became a close friend and colleague of Ampère.

Inspired by the observations made by Ørsted in 1820, André-Marie Ampère, a few months after Ørsted's findings, published a report analyzing the electromagnetic phenomena observed by Ørsted. Based on carefully designed experiments, Ampère formulated a mathematical expression for the electromagnetic force between moving charges and the electric current in a conductor. He published the results in the

treatise *Mémoire sur la théorie mathématique des phénomènes électrodynamiques uniquement déduite de l'expérience* (*Memoir on the Mathematical Theory of Electrodynamic Phenomena, Uniquely Deduced from Experience*) in 1827. Ampère's work had an important role for the later development of the theory of electromagnetism.

Ampère experienced some very tragic events; his father who gave him his basic education was guillotined in the French revolution in 1792. In the same year he also lost his sister. Ampère was married in 1797, but his wife died after six years of marriage. In his later years he suffered from problematic relations with his son and his daughter's alcoholic husband living in his house.

<http://www-history.mcs.st-and.ac.uk/Biographies/Ampere.html>

[http://en.wikipedia.org/wiki/Andr%C3%A9-Marie\\_Amp%C3%A8re](http://en.wikipedia.org/wiki/Andr%C3%A9-Marie_Amp%C3%A8re)

André-Marie Ampère, e-books [openlibrary.org](http://openlibrary.org)

## Amedeo Avogadro (1776–1856)



Amedeo Avogadro was an Italian physicist and mathematician born in Turin, in northwestern Italy. He is best known for the *Avogadro constant* named after him.

Shortly after his graduation in Cannon law, Avogadro dedicated himself to physics and mathematics, and became a teacher in 1809. The idea of the Avogadro constant matured as a part of his studies on gas theory that he published in his treatise *Essai d'une manière de déterminer les masses relatives des molécules élémentaires des corps, et les proportions selon lesquelles elles entrent dans ces combinaisons* (*Essay on Determining the Relative Masses of the Elementary Molecules of Bodies and the Proportions by Which They Enter These Combinations*) in 1811.

Avogadro developed the hypothesis of the Avogadro constant after Joseph Louis Gay-Lussac had published, in 1808, his law on volumes (and combining gases). He deduced that equal volumes of two different gases at equal pressure and temperature contain the same number of atoms or molecules. One of his most important contributions was distinguishing atoms from molecules, stating that gases are composed of molecules, and these molecules are composed of atoms. Also, he noticed the difference between *mass* and *weight*.

For a long time, Avogadro's work did not receive major attention. Some experimental observations contradicted his theory, until in 1860, the Italian chemist Stanislao Cannizzaro explained the contradictions as consequences of the dissociation of molecules. As a result, Avogadro's law became confirmed both for atoms and molecules.

[http://en.wikipedia.org/wiki/Amedeo\\_Avogadro](http://en.wikipedia.org/wiki/Amedeo_Avogadro)

*Fisica de' corpi ponderabili* (1837), [openlibrary.org](http://openlibrary.org)



## Hans Christian Ørsted (1777–1851)

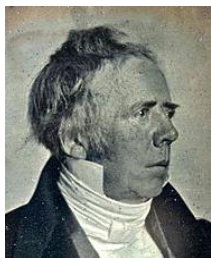

Christian Ørsted was a Danish physicist and chemist who discovered the interaction between magnetism and electric currents. Christian Ørsted was born in the city of Rudkøbing on the island of Langeland in Denmark. He received most of his early education through self-study at home, before going to the University of Copenhagen in 1793.

In 1801, Ørsted received a travel scholarship which enabled him to spend three years travelling across Europe. In Germany, he met Johann Wilhelm Ritter, a physicist who believed that there was a connection between electricity and magnetism. This made sense to Ørsted since he believed in Kantian ideas about the unity of nature and that deep relationships existed among natural phenomena.

He became a professor at the University of Copenhagen in 1806, and continued his research on electric currents and acoustics. Under his guidance the University developed a comprehensive physics and chemistry program and established new laboratories.

In 1820, during a lecture, Ørsted noticed that a compass needle deflected from magnetic north when an electric current from a battery was switched on and off, confirming a direct relationship between electricity and magnetism. After more intensive investigations he published his findings, showing that an electric current produces a circular magnetic field around a conductor. This discovery was not due to mere chance, since Ørsted had been looking for a relation between electricity and magnetism for several years. The special symmetry of the phenomenon was possibly one of the difficulties that delayed the discovery.

[http://en.wikipedia.org/wiki/Hans\\_Christian\\_%C3%98rsted](http://en.wikipedia.org/wiki/Hans_Christian_%C3%98rsted)

## Carl Friedrich Gauss (1777–1855)



Carl Friedrich Gauss was a German mathematician and physical scientist who contributed significantly to many fields, including number theory, statistics, analysis, differential geometry, geodesy, geophysics, electrostatics, astronomy and optics.

Gauss was born in Brunswick, now part of Lower Saxony, Germany, as the son of poor working-class parents. Gauss was a child prodigy, and he made his first ground-breaking mathematical discoveries while still a teenager. Gauss's exceptional abilities were noticed immediately at elementary school. In 1792, after receiving a stipend from the Duke of Braunschweig, he was sent to the Collegium Carolinum (now Technische Universität Braunschweig), and to the University of Göttingen in 1795.

In his dissertation, *A new proof of the theorem that every integral rational algebraic function of one variable can be resolved into real factors of the first or second degree*, Gauss proved the

fundamental theorem of algebra which states that every non-constant single-variable polynomial with complex coefficients has at least one complex root.

Gauss also made important contributions to number theory with his 1801 book *Disquisitiones Arithmeticae* (*Arithmetical Investigations*), in which, he discussed the works of Fermat, Euler, Lagrange and Legendre, and presented, among other things, the first two proofs of the law of quadratic reciprocity, developed the theories of binary and ternary quadratic forms, and showed that a regular heptadecagon (17-sided polygon) can be constructed with a straightedge and compass.

In 1809, Gauss published a book on celestial mechanics, *Theoria motus corporum coelestium in sectionibus conicis solem ambientum* (*Theory of motion of the celestial bodies moving in conic sections around the Sun*), and in 1827, a book on differential geometry, *Disquisitiones Generales Circa Superficies Curvas* (*General Investigations of Curved Surfaces*), discussing, among other things, the curvature of three-dimensional space.

In 1807, Gauss was appointed Professor of Astronomy and Director of the astronomical observatory in Göttingen, a post he held for the remainder of his life. In 1831, Gauss developed a fruitful collaboration with the physics professor Wilhelm Weber, leading to new knowledge in magnetism and the discovery of Kirchhoff's circuit laws in electricity. Together with Weber, he constructed the first electromechanical telegraph that connected the observatory with the institute for physics in Göttingen, about three kilometers from the observatory.

<http://www-history.mcs.st-and.ac.uk/Biographies/Gauss.html>

[http://en.wikipedia.org/wiki/Carl\\_Friedrich\\_Gauss](http://en.wikipedia.org/wiki/Carl_Friedrich_Gauss)

Carl Friedrich Gauss, *Werke* [openlibrary.org](http://openlibrary.org)

*Theory of the Motion of the Heavenly Bodies Moving about the Sun in Conic Sections: Gauss's Theoria Motus* by

Charles Henry Davis (1857), [openlibrary.org](http://openlibrary.org)

Carl Friedrich Gauss, e-books, [openlibrary.org](http://openlibrary.org)

## Siméon Denis Poisson (1781–1840)



Siméon Denis Poisson was a French mathematician, geometer, and physicist, born in Pithiviers, Loiret, to the south from Paris. Poisson is best known for the *Poisson's equation* that is a generalized form of Laplace's potential equation.

From 1798, Siméon Poisson studied in the École Polytechnique in Paris with, among others, Joseph Louis Lagrange and Pierre-Simon Laplace as his teachers. He was made deputy professor of mathematics in 1802, and, in 1806 full professor, succeeding Jean Baptiste Joseph Fourier. A few years later he was nominated professor in mechanics.

Poisson's passions were mathematics and teaching. He continued Laplace's work on the stability of planetary orbits. Following Laplace, he also developed the corpuscular theory of light, and opposed the wave theory presented by Fresnel. Poisson believed that he could disprove Fresnel's theory by showing that a light point predicted by Fresnel's theory at the center of the shadow of a spherical object does not

appear. An experiment arranged by François Arago, however, showed that the light point appeared exactly as Fresnel's theory predicted. The light point is known either as "Arago's point" or "Poisson's" point.

[http://en.wikipedia.org/wiki/Sim%C3%A9on\\_Denis\\_Poisson](http://en.wikipedia.org/wiki/Sim%C3%A9on_Denis_Poisson)

*A Treatise on Mechanics*, English translation Henry H. Harte (1842), [openlibrary.org](http://openlibrary.org)

Siméon Denis Poisson, e-books, [openlibrary.org](http://openlibrary.org)

## François Arago (1786–1853)



François Arago was a French mathematician, physicist, astronomer and politician. François Arago was born at Estagel, a small village near Perpignan, near the Mediterranean Coast in southern France.

In 1803, with a military career in mind, Arago entered the École Polytechnique as a student, and soon as a colleague, of Siméon Poisson. In 1804, through the advice and recommendation of Siméon Poisson, he received the appointment of secretary to the Paris Observatory and became commissioned to the meridian arc measurements that had been begun by Delambre. The commission led to an un-expected adventure due the political turbulence. His success, however, was rewarded with a membership in the French Academy of Sciences, at the remarkably early age of twenty-three in 1809. The same year, he was chosen to succeed Gaspard Monge in the chair of analytical geometry at École Polytechnique.

Arago was one of the strong supporters of Thomas Young's and Augustin-Jean Fresnel's wave theory of light. Together with Fresnel, he studied the polarization of light, discovered circular polarization and invented the polarization filter in 1812. Also, he proposed the measurement of the velocity of light by using rotating mirrors; the experiment was carried out by Fizeau and Foucault in 1850.

Besides his other duties, Arago gave popular public lectures on astronomy from 1813 to 1845. He served as the secretary of the Academy and started the *Proceedings of the Academy of Sciences* publication series in 1835.

<http://www-history.mcs.st-and.ac.uk/Biographies/Arago.html>

[http://en.wikipedia.org/wiki/Fran%C3%A7ois\\_Arago](http://en.wikipedia.org/wiki/Fran%C3%A7ois_Arago)

François Arago, e-books, [openlibrary.org](http://openlibrary.org)

## Augustin-Jean Fresnel (1788–1827)



Augustin-Jean Fresnel was a French engineer who contributed significantly to the establishment of the theory of wave optics. Augustin-Jean Fresnel was born in Broglie in Haute-Normandie in northern France. In 1801, he entered the École Centrale in Caen, and in 1804, at the age of sixteen, the École Polytechnique, and completed his civil engineer's degree at the École des Ponts et Chaussées in three years.

After graduation, Fresnel was involved in road building projects until he gradually began to undertake experiments with light in his spare time around 1812. Due to political turbulence he had to leave his engineering job – which gave him the time he needed to concentrate on his experiments with light. By combining mathematical analyses and experiments, he became fully convinced of the wave theory – without being aware of the prior works by Huygens, Euler, and Young.

Based on the phase of the light waves, Fresnel was able to derive formulae, which gave the position of the bright and dark lines in his diffraction experiments. In 1815, he published his first paper on the wave theory of light and made a first attempt to explain the phenomenon of diffraction. He then used his mathematical formulae for calculating the interference patterns obtained by reflecting a light source with two mirrors and continued his experimentation with polarization.

In 1817, the Academy of Sciences announced that the Grand Prix for 1819 would be awarded to the best work on diffraction. In 1819, the committee to judge the Grand Prix of the Académie des Sciences, with Arago as chairman, and including Poisson, Biot and Laplace, met to consider Fresnel's submission. After experimental verification of the "Poisson's point", the Grand Prix for 1819 was granted to Fresnel.

Fresnel had perceived the wave mechanism of light by intuition. With his practical approach and necessary skills in mathematics he was able to verify his intuition in many details. In 1821, Fresnel showed that for understanding the polarization effects, we must assume that light must be described as transverse wave. Also, Fresnel developed an "ether drag" theory, according to which the motion of an optically dense medium affects the velocity light propagating in the medium. A few decades later, the French physicist, Hippolyte Fizeau verified Fresnel's prediction on the "ether drag" in his experiments with flowing water.

Fresnel received only scant public recognition for his works during his lifetime. Some of his papers were not printed by the Academy of Sciences until many years after his death. In 1824, he wrote to Thomas Young: "... *that sensibility, or that vanity, which people call love of glory had been blunted – All the compliments that I have received from Arago, Laplace and Biot never gave me so much pleasure as the discovery of a theoretic truth, or the confirmation of a calculation by experiment*".

Fresnel died of tuberculosis in 1827 at the age of 39 years. As an experimental scientist, Fresnel did not speculate on the *aether* or any other media that might carry light. The possible existence of an aether did not become a major question until early 20<sup>th</sup> century when the need for an aether postulate was eliminated in the framework of the theory of special relativity.

<http://www-history.mcs.st-and.ac.uk/Biographies/Fresnel.html>

[http://en.wikipedia.org/wiki/Augustin\\_Fresnel](http://en.wikipedia.org/wiki/Augustin_Fresnel)

*The Wave Theory of Light, Memoirs by Huygens, Young and Fresnel* (1900), Henry Crew (editor), [openlibrary.org](http://openlibrary.org)

## Georg Simon Ohm (1789–1854)



Georg Ohm was a German physicist and mathematician born in Erlangen, in modern day South Germany. He is best known for “Ohm’s law”, and the unit of electrical resistance, ohm, named after him. Ohm received basic schooling in mathematics, physics, chemistry and philosophy from his highly educated father.

From 1806 to 1809, Ohm worked as a mathematics teacher in Gottstadt, Switzerland, and continued his own studies in mathematics by reading the works of Euler, Laplace, Lacroix, and others. He received his doctorate from the University of Erlangen in 1811, and continued as a teacher of mathematics, first in the university and later in a school in Bamberg.

In 1817, Ohm moved to the Jesuit Gymnasium of Cologne that offered him a well-equipped physics laboratory. Ohm started his own experimentation after hearing about Ørsted’s observations on the electromagnetic effect. He observed that the electric current through a conductor was directly proportional to the voltage across the conductor, which became known as “Ohm’s law”.

Ohm assumed that an electric current is a continuous action without action at a distance. He published his results in the book *Die galvanische Kette, mathematisch bearbeitet* (*The Galvanic Circuit Investigated Mathematically*) in 1827.

<http://www-history.mcs.st-andrews.ac.uk/Biographies/Ohm.html>

[http://en.wikipedia.org/wiki/Georg\\_Ohm](http://en.wikipedia.org/wiki/Georg_Ohm)

Georg Ohm, *Die galvanische kette* (1827), [openlibrary.org](https://openlibrary.org),

Georg Ohm, *The Galvanic Circuit Investigated Mathematically*, [openlibrary.org](https://openlibrary.org)

## Michael Faraday (1791–1867)



Michael Faraday was a self-educated British scientist and one of the most influential experimentalists in the history of science. He is known for many important findings and phenomena in electromagnetism bearing his name.

Michael Faraday was born in Newington Butts, a village now in the London area in England. His father was a blacksmith; to find a job he moved his family to London, where Michael attended a day school where he learned to read, write and count. When Faraday was thirteen years old he had to find work to help the family finances and he was employed running errands for a bookseller, and soon became an apprentice bookbinder. The bookbinder’s job offered him the opportunity of reading books in his spare time. During his seven-year apprenticeship he read many books, including Isaac Watt’s *The Improvement of the Mind*, and he enthusiastically implemented the principles and suggestions contained therein. He became interested in science, especially in electricity.

Faraday was particularly inspired by the book *Conversations on Chemistry* by Jane Marcet.

In 1808, the British scientist and philosopher, John Tatum started the City Philosophical Society. Michael Faraday had the opportunity of attending lectures at John Tatum's house. He attended lectures on many different topics, but he was particularly interested in those on electricity, galvanism and mechanics. At Tatum's house he made two special friends, J. Huxtable who was a medical student, and Benjamin Abbott who was a clerk.

In 1812, Faraday had the opportunity to attend lectures by Humphry Davy at the Royal Institution and made careful copies of the notes he had taken. Faraday wrote to Sir Joseph Banks, the President of the Royal Society, asking how he could become involved in scientific work – without getting a reply. He then wrote to Humphry Davy, who had been his hero since he attended his chemistry lectures, sending him copies of a three-hundred-page book based on the notes he had taken at Davy's lectures. Davy's reply was immediate, kind, and favorable. When Davy damaged his eyesight in an accident he decided to employ Faraday as a secretary.

In 1813, Davy set out on a scientific tour of Europe and he took Faraday with him as his assistant and secretary. Faraday met Ampère and other scientists in Paris. They travelled on towards Italy where they spent time in Genoa, Florence, Rome and Naples. Heading north again they visited Milan where Faraday met Volta.

In 1820, Davy became interested in Arago's and Ampère's observations on the interactions between electricity and magnetism, and tried, without success, to construct an electric motor. However, Faraday succeeded with his design and construction of a homopolar motor. Unfortunately, in his excitement, Faraday published results without acknowledging his work with either Wollaston or Davy. The resulting controversy within the Royal Society strained his mentor relationship with Davy and may have contributed to Faraday's assignment to other activities, which consequently prevented his involvement in electromagnetic research for several years.

Two years after the death of Davy, in 1831, Faraday began his great series of experiments in which he discovered electromagnetic induction. The American physicist, Joseph Henry likely had discovered self-induction a few months earlier and both may have been anticipated by the work of the Italian priest and physicist, Francesco Zantedeschi in Italy in 1829 and 1830. Faraday's careful notes of his experiments on induction were essential for the formulation of Maxwell's equations.

In 1839, Faraday demonstrated that the electric charge resided only on the exterior of a charged conductor, and exterior charge had no influence on anything enclosed within a conductor. This shielding effect is used in what is now known as a Faraday cage.

Faraday's ideas on lines of force had received a mathematical treatment from the British mathematical physicist William Thomson. In 1845, he wrote to Faraday telling him of his mathematical predictions that a magnetic field should affect the plane of polarized light. Faraday had attempted to detect this experimentally many years earlier but without success. Now, with the idea reinforced by Thomson, he tried again, and he was successful in showing that a strong magnetic field could rotate the

plane of polarization, and moreover that the angle of rotation was proportional to the strength of the magnetic field.

Faraday is mainly known for his works on electromagnetism. However, as Humphry Davy's assistant, he also made remarkable findings in chemistry and electrochemistry. He succeeded in liquefying several gases, developed metal alloys, glass mixtures for optical purposes, invented the early form of the Bunsen burner, and described the optical properties of nano particles. Faraday discovered the laws of electrolysis; he determined the *Faraday constant* that defined the electric charge that was needed for the transport of a mole of matter in electrolysis. The charge related to a mole indicated the close connection of a unit charge and an atom, as recognized by George Stoney in the 1870s.

In June 1832, the University of Oxford granted Faraday a Doctor of Civil Law degree (honorary). During his lifetime, Faraday rejected a knighthood and twice refused to become President of the Royal Society.

<http://www-history.mcs.st-and.ac.uk/Biographies/Faraday.html>

[http://en.wikipedia.org/wiki/Michael\\_Faraday](http://en.wikipedia.org/wiki/Michael_Faraday)

Michael Faraday's publications: [http://en.wikisource.org/wiki/Author:Michael\\_Faraday](http://en.wikisource.org/wiki/Author:Michael_Faraday)

*The Life and Discoveries of Michael Faraday* by James Arnold Crowther (1920), [openlibrary.org](http://openlibrary.org)

M. Faraday by J.H. Gladstone (1874), [openlibrary.org](http://openlibrary.org)

M. Faraday, *Experimental researches in electricity* (1839, 1914, 1922), [openlibrary.org](http://openlibrary.org)

M. Faraday, *A course of six lectures on the various forces of matter and their relations to each other* (1860), [openlibrary.org](http://openlibrary.org)

## Gustave Coriolis (1792–1843)



Gustave Coriolis was a French mathematician, mechanical engineer and scientist. He is best known for his analysis of rotating systems, and the *Coriolis force* named after him.

Gustave Coriolis was born in Paris, attended school in Nancy and studied engineering sciences at the École Polytechnique. After his studies, Coriolis started to develop the mathematics needed in rotating machines. As a part of that job he defined the concepts of *work* and *kinetic energy*. He derived the expres-

sion for kinetic energy,  $\frac{1}{2}mv^2$ , published in the textbook for mechanics *Calcul de l'Effet des Machines (Calculation of the Effect of Machines)* in 1829.

In 1835, he published a mathematical work on collisions of spheres: *Théorie Mathématique des Effets du Jeu de Billard*.

<http://www-history.mcs.st-and.ac.uk/Biographies/Coriolis.html>

[http://en.wikipedia.org/wiki/Gustave\\_Coriolis](http://en.wikipedia.org/wiki/Gustave_Coriolis)

## Sadi Carnot (1796–1832)



Sadi Carnot was a French military engineer, who is known for his work on the basis of thermodynamics and the *Carnot cycle* named after him.

Sadi Carnot was born in Paris; he got his basic education from his father. At the age of sixteen, he entered the *École Polytechnique*, where he was taught, among others, by Siméon-Denis Poisson, André-Marie Ampère, and François Arago. After graduation Carnot went to the *École du Génie* at Metz to take the two-year course in military engineering.

After a short military career Carnot returned to Paris and attended courses at various institutions. He was interested in steam machines; his major work was a paper on mathematics for the work produced by one kilogram of steam, *Réflexions sur la puissance motrice du feu et sur les machines propres à développer cette puissance* (*Reflections on the Motive Power of Fire and on machines that develop this power*), published in 1824. In the paper he introduces the *Carnot cycle*.

Carnot realized that the ideal Carnot cycle is reversible, which meant that mechanical work can be used to develop temperature differences.

[http://www-history.mcs.st-and.ac.uk/Biographies/Carnot\\_Sadi.html](http://www-history.mcs.st-and.ac.uk/Biographies/Carnot_Sadi.html)

[http://en.wikipedia.org/wiki/Nicolas\\_L%C3%A9onard\\_Sadi\\_Carnot](http://en.wikipedia.org/wiki/Nicolas_L%C3%A9onard_Sadi_Carnot)

Sadi Carnot, *Reflections on the Motive Power of Heat* by W. Thomson (Lord Kelvin), (1897), [openlibrary.org](http://openlibrary.org)

## Benoît Paul Émile Clapeyron (1799–1864)

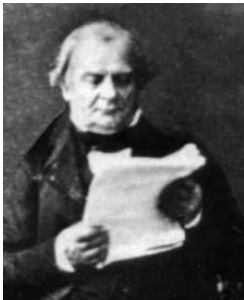

Émile Clapeyron was a French engineer and physicist, and one of the founders of thermodynamics.

Clapeyron was born in Paris and got his education in the *École Polytechnique* and *École des Mines*. After graduation, he spent ten years as a teacher in St. Petersburg. He returned to Paris in 1830, supervising the construction of the first railway line connecting Paris to Versailles and Saint-Germain.

In his treatise *Puissance motrice de la chaleur* (*The Driving force of the heat*) published in 1834, Clapeyron refined Carnot's work in an analytic graphical form, showing the Carnot cycle as a closed curve on an indicator diagram, a chart of pressure against volume (named in his honor Clapeyron's graph). Also, he refined *Carnot's principle* that essentially defines the second law of thermodynamics.

<http://www-history.mcs.st-and.ac.uk/Biographies/Clapeyron.html>

<http://en.wikipedia.org/wiki/Clapeyron>



## Christian Doppler (1803–1853)



Christian Doppler was an Austrian mathematician and physicist known for the Doppler effect named after him.

Christian Doppler came from Salzburg, Austria. He was graduated from Polytechnisches Institut (now Vienna University of Technology) in 1825, and continued studies in mathematics and astronomy at the University of Vienna, where he worked as an assistant for the professor in mathematics from 1829. Later he was appointed professor of mathematics and geometry in Prague Polytechnic (now Czech Technical University). After a short professorship of mathematics, physics, and mechanics at the Academy of Mines and Forests in Schemnitz (Banská Štiavnica, Slovakia), he moved to Vienna in 1849. In Vienna, Doppler's time as the first Director of the Institute of Physics at Vienna University remained short, due to his death in 1853 at the age of 50 years.

Christian Doppler's most notable work was, *Über das farbige Licht der Doppelsterne und einiger anderer Gestirne des Himmels* (*On the coloured light of the binary stars and some other stars of the heavens*). In this work, Doppler postulated "the Doppler effect" that the observed frequency of a wave depends on the relative speed of the source and the observer, and he tried to use this concept for explaining the color of binary stars. In his work Doppler describes the frequency effect both for light and sound. In 1846, he augmented his theory by observing the velocities of the source and the observer, separately.

<http://www-history.mcs.st-and.ac.uk/Biographies/Doppler.html>

[http://en.wikipedia.org/wiki/Christian\\_Doppler](http://en.wikipedia.org/wiki/Christian_Doppler)

## Wilhelm Eduard Weber (1804–1891)



Wilhelm Weber was a German physicist, born in Wittenberg in eastern Germany.

Wilhelm got his basic education from his father who was a professor of theology. In 1821, at the age of seventeen, he studied in the Francke Institute preparing to enter the University of Halle. Together with his brother, he studied sound waves and the flow of liquids. They published the results as a 575-page monograph *Wellenlehre auf Experimente gegründet* (*Wave theory based on experiments*), in 1825. In the monograph they formulated the basic laws of hydrodynamics.

Wilhelm Weber continued doing wave experiments, especially for acoustics, and wrote several publications on these. With his younger brother he published treatises on the mechanism of walking in 1825–1838. Wilhelm Weber wrote his doctoral dissertation on the theory of reed organ pipes, which he submitted in 1826.

Wilhelm Weber was appointed as Extraordinary Professor of natural philosophy at Halle in 1826. In 1827, when Weber gave a presentation on this thesis in a conference in Berlin, Carl Friedrich Gauss got interested and saw the potential of the young physicist. At this time Gauss was interested in geomagnetism and he realized that Weber would make an outstanding co-worker. In 1831, Weber was offered a professorship in physics at Göttingen. There followed six years of close friendship and collaboration between Weber and Gauss. He soon gained an excellent reputation as a lecturer, illustrating his lectures with experiments. He opened the physical laboratory at Göttingen for student use.

In 1833, Gauss and Weber established the *Magnetische Verein (Magnetic Club)* for mapping the terrestrial magnetism around the world. Cooperation with the Royal Society resulted in the publication *Atlas Des Erdmagnetismus: Nach Den Elementen Der Theorie Entworfen*<sup>1</sup> in 1840, which contains magnetic maps constructed using a network of magnetic observatories that they had organized from 1836 onwards to correlate measurements of terrestrial magnetism around the world.

For enhancing their cooperation Weber and Gauss constructed a battery-operated telegraph, 3 km long, connecting the Physics Laboratory and the Astronomical Observatory at Göttingen.

Due to political turbulence in the 1830s, Weber had to resign his professorship in Göttingen. In 1843, he became professor of physics at Leipzig and continued the work on electromagnetism he had started in Göttingen. The publication summarizing the work *Electrodynamische Massenbestimmungen (Electrodynamical Measurements)* provided the basis for the definition of electromagnetic quantities. Also, Weber linked together the interaction of charges at rest, Ampère's law for moving charges, and Faraday's lines of force describing electromagnetic induction.

After new political changes, William Weber returned to Göttingen in 1849, and succeeded Gauss as Director of the Astronomical Observatory. After Gauss's death in 1855, Weber worked with Rudolph Hermann and Arndt Kohlrausch. As a result of the cooperation Weber formulated an expression for electromagnetic force with both static and dynamic components. He showed that the inverse of the square root of the product of the electric and magnetic constants,  $1/\sqrt{\epsilon_0\mu_0}$  was a velocity equal to the velocity of light, about  $3 \cdot 10^8$  m/s. Weber denoted the velocity with  $c$  which became the symbol for the velocity of light. In his last years in Göttingen, Weber studied the electric structure of matter.

<http://www-history.mcs.st-andrews.ac.uk/Biographies/Weber.html>

[http://en.wikipedia.org/wiki/Wilhelm\\_Eduard\\_Weber](http://en.wikipedia.org/wiki/Wilhelm_Eduard_Weber)

Wilhelm Weber, *Werke* (1893), [openlibrary.org](http://openlibrary.org)

A.K.T. Assis, H. Torres Silva, *Comparison between Weber's electrodynamics and classical electrodynamics*, Pragma – J. Phys., Vol. 55, No. 3, September 2000

<sup>1</sup> [http://www.phy6.org/earthmag/mill\\_4.htm](http://www.phy6.org/earthmag/mill_4.htm)

## William Hamilton (1805–1865)

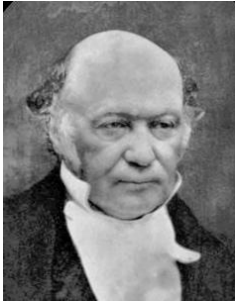

William Hamilton was an Irish physicist, astronomer, and mathematician, who made important contributions to classical mechanics, optics, and algebra. In addition, he made major contribution in the development of the formalisms in classical mechanics.

Hamilton was born in Dublin. At the age of three, Hamilton was sent to live with his uncle James Hamilton, who ran a school in Talbots Castle. Very soon he discovered Hamilton's exceptional abilities in mathematics and languages. By the age of twelve, Hamilton had mastered the classical and modern European languages, and Persian, Arabic, Hindustani, Sanskrit, and even Marathi and Malay. At age of eighteen, he became a member of a small but well-regarded school of mathematicians associated with Trinity College, Dublin, where he spent his life.

Hamilton is best known for his work on optics and analytical mechanics. In 1828, in his article *Theory of Systems of Rays* in the *Transactions of the Royal Irish Academy*, he introduced the bases of the formulation of classical mechanics in terms of the Hamilton function. In an additional part of the article, *On a General Method in Dynamics*, in 1834, he introduced the principle of *varying action* that allowed the study of systems with both particles and radiation.

In mathematics, Hamilton is also known as the inventor of the quaternion.

Hamilton was knighted in 1835. Hamilton died from a severe attack of gout shortly after receiving the news that he had been elected the first foreign member of the National Academy of Sciences of the USA.

<http://www-history.mcs.st-and.ac.uk/Biographies/Hamilton.html>

[http://en.wikipedia.org/wiki/William\\_Rowan\\_Hamilton](http://en.wikipedia.org/wiki/William_Rowan_Hamilton)

*Life of Sir William Rowan Hamilton,*

Vol I, <http://archive.org/stream/lifeofsirwilliam01gravuoft>

Vol II, <http://archive.org/stream/lifeofsirwilliam02grav>

Vol III, <http://archive.org/stream/lifeofsirwilliam03gravuoft>

*On a general method in dynamics: From the Philosophical transactions*, Part 2 for 1834, [openlibrary.org](http://openlibrary.org)

*Lectures on Quaternions* (1853), [openlibrary.org](http://openlibrary.org)

## Julius von Mayer (1814–1878)



Julius von Mayer was a German physician and physicist and one of the founders of thermodynamics. He was born in Heilbronn, Württemberg (Baden-Württemberg, modern day Germany). He studied medicine at the University of Tübingen, and attained his doctorate in 1838.

Soon after his graduation he left as a ship's physician for a journey to Jakarta. During the trip he paid attention to the observation that storm-whipped waves are warmer than the calm

sea, which made him think about the laws of nature behind the phenomenon. After his return in 1841, he dedicated his efforts to solve this problem.

He is best known for enunciating, in 1841, one of the original statements of the conservation of energy or what is now known as one of the first versions of the first law of thermodynamics, namely,

“Energy can be neither created nor destroyed”.

Mayer determined the numerical value of the mechanical equivalent of heat, and obtained the value 4.168 J/cal that he published in 1842 in his treatise *Die organische Bewegung im Zusammenhang mit dem Stoffwechsel* (*The Organic Movement in Connection with the Metabolism*), published in *Annalen der Chemie und Pharmacie* in 1845. The value of the mechanical equivalent was published at about the same time by James Joule, who is generally given the credit for it. Mayer’s heat equivalent value, however, was more accurate than Joule’s, and is only 0.4% lower than the modern value.

Julius von Mayer realized that slow combustion (i.e. oxidation) is the energy source of all living creatures. Also, he suggested that the light from the Sun is converted into chemical energy in plants. He estimated that the Sun would cool down in 5000 years if it did not have a source of heat.

The first reaction of contemporary physicists, including Hermann von Helmholtz and James Prescott Joule, was to reject Mayer’s principle of the conservation of energy, and they viewed his ideas with hostility. The former doubted Mayer’s qualifications in physical questions, and a bitter dispute over priority developed with the latter.

Finally, in 1859, Mayer was awarded an honorary doctorate by the philosophical faculty at the University of Tübingen. His overlooked work was revived in 1862 by fellow physicist John Tyndall in a lecture at the London Royal Institution. In July 1867, Mayer published *Die Mechanik der Wärme*. This publication dealt with the mechanics of heat and its motion. In 1867, Mayer was awarded personal nobility (von Mayer) which is the German equivalent of a British knighthood.

[http://en.wikipedia.org/wiki/Julius\\_von\\_Mayer](http://en.wikipedia.org/wiki/Julius_von_Mayer)

Julius Robert von Mayer, *Die Mechanik der Wärme: In gesammelten Schriften* (1867), [openlibrary.org](http://openlibrary.org)

## James Joule (1818–1889)



James Joule was an English physicist and brewer, born in Salford, Lancashire. He is best known for Joule’s law and the unit of energy, joule, named after him.

For Joule, after his short schooling under John Dalton’s tutoring, science was more like a hobby, and he started to investigate the feasibility of replacing the brewery’s steam engines with the newly invented electric motor. This practical experimentation led him to the recognition of the equivalence between mechanical work, electric current, and heat.

He formulated his laws in 1840. The first law states the amount of heat produced by an electric current in a conductor, and also defines the unit *joule*. The second law states that the internal energy of an ideal gas is independent of its volume and pressure and depends only on its temperature.

Joule determined the mechanical equivalent of heat using several calorimetric methods. He presented the first results in the meeting of the British Association for the Advancement of Science in the city of Cork in 1843. The response to his findings was modest. He continued the measurements and published the new results in his treatise *On the mechanical equivalent of heat*, which he presented in the British Association meeting in Cambridge in 1845. The heat equivalence Joule obtained at that time was 4.14 J/cal.

James Joule's and Julius Mayer's works provided a solid, quantitative basis to the first law of thermodynamics.

Hermann Helmholtz became aware both of Joule's work and the similar 1842 work of Julius Robert von Mayer. Though both men had been neglected since their respective publications, Helmholtz's definitive 1847 declaration of the conservation of energy credited them both.

[http://en.wikipedia.org/wiki/James\\_Joule](http://en.wikipedia.org/wiki/James_Joule)

*The scientific papers of James Prescott Joule* (1884), [openlibrary.org](http://openlibrary.org)

Papers by James Joule: [wikisource.org](http://wikisource.org)

## Léon Foucault (1819–1868)



Léon Foucault was a French physicist best known for the invention of the *Foucault pendulum*, a device demonstrating the effect of the Earth's rotation.

Léon Foucault was born in Paris. He received his basic education mainly at home. In his later studies he moved from medicine to physics, and served as an assistant in microscopic anatomy. In 1850, he, together with Hippolyte Fizeau, measured the velocity of light using a system based on a rotating mirror, which originally had been suggested by Fresnel.

In 1851, he provided the first experimental demonstration of the rotation of the Earth on its axis using the first *Foucault pendulum*, a long and heavy pendulum suspended from the roof of the Panthéon in Paris. The actual plane of swing appears to rotate relative to the Earth; in fact, the plane is fixed in space while the Earth rotates under the pendulum once a sidereal day.

The experiment caused a sensation in both the learned and popular worlds, and "Foucault pendulums" were suspended in major cities across Europe and America.

<http://www-history.mcs.st-and.ac.uk/Biographies/Foucault.html>

[http://en.wikipedia.org/wiki/L%C3%A9on\\_Foucault](http://en.wikipedia.org/wiki/L%C3%A9on_Foucault)

## Hippolyte Fizeau (1819–1896)

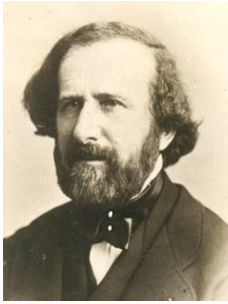

Hippolyte Fizeau was a French physicist born in Paris. Fizeau studied medicine together with his fellow student and colleague Léon Foucault. Fizeau directed experimental studies with Léon Foucault, and made major improvements to photographic plates. He attended Arago's courses in the Paris Observatory, and studied mathematics and physics from the notes his brother had made at the *École Polytechnique*.

Following suggestions by François Arago, Léon Foucault and Fizeau collaborated in a series of investigations on the interference of light and heat. One of the experiments was the *ether drag* experiment with flowing water in 1851. The experiment confirmed the prediction derived by Fresnel three decades earlier.

Being unaware of Doppler's 1842 publication, Fizeau, in 1848, predicted the redshift of electromagnetic waves. He suggested that the displacement of spectral lines in stellar spectra could be used for the determination of celestial velocities. The term redshift was adopted by the American astronomer Walter S. Adams in 1908. In 1864, Fizeau suggested that the wavelength of a selected light wave could be used as a length standard.

<http://www-history.mcs.st-and.ac.uk/Biographies/Fizeau.html>

[http://en.wikipedia.org/wiki/Hippolyte\\_Fizeau](http://en.wikipedia.org/wiki/Hippolyte_Fizeau)

Hippolyte Fizeau, *Hypotheses on luminous ether and on an experiment that appears to demonstrate that the motion of bodies changes the velocity with which light propagates in their interior* (1859), [wikisource.org](http://www.wikisource.org)

Hippolyte Fizeau, *On the Effect of the Motion of a Body upon the Velocity with which it is traversed by Light* (1860), [wikisource.org](http://www.wikisource.org)

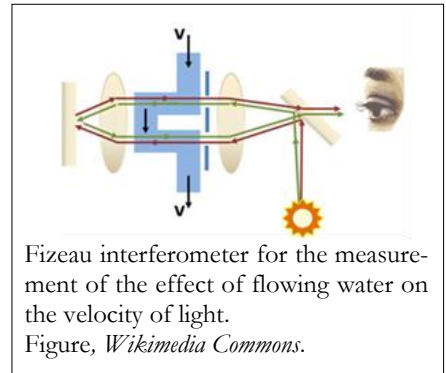

Fizeau interferometer for the measurement of the effect of flowing water on the velocity of light.  
Figure, *Wikimedia Commons*.

## George Stokes (1819–1903)



Sir George Stokes was an Irish mathematician and physicist, who made important contributions to fluid dynamics, optics, and mathematical physics.

In 1849, Stokes was appointed to the Lucasian professorship of mathematics at Cambridge, a position he held until his death in 1903. Stokes had studied carefully the mathematics by Lagrange, Laplace, Fourier, Poisson and Cauchy. Together with James Clerk Maxwell and Lord Kelvin, he was one of the famous natural philosophers who contributed to the fame of the Cambridge school of mathematical physics in the middle of the 19th century.

Stokes discovered *Stoke's law* in 1851, when studying pendulums in viscous fluids. In 1852, he discovered the phenomenon of fluorescence; he observed that ultraviolet light focused on a fluorescent material resulted in emission of blue light. He explained the phenomenon with elastic aether that vibrates as a consequence of the illuminated molecules. Stokes assumed that the velocity of light is related to *aether* drawn along by Earth. Stoke's ideas of the local aether did not prove useful.

Stokes served as the president of the Royal Society between 1885 and 1890 after being one of its secretaries since 1854.

<http://www-history.mcs.st-and.ac.uk/Biographies/Stokes.html>

[http://en.wikipedia.org/wiki/Sir\\_George\\_Stokes,\\_1st\\_Baronet](http://en.wikipedia.org/wiki/Sir_George_Stokes,_1st_Baronet)

George Stokes, *Science and Revelation* (1887), [wikisource.org](http://www.wikisource.org)

## Hermann von Helmholtz (1821–1894)



Hermann von Helmholtz was a German physician and physicist who is generally credited for recognizing the principle of conservation of energy as a primary law of nature.

In his book *Dictionary of Scientific Biography* Steven Turner characterizes Helmholtz as " ...the last great scholar whose work, in the tradition of Leibniz, embraced all the sciences, as well as philosophy and the fine arts."

Hermann von Helmholtz was born in Potsdam in eastern Germany. Hermann was attracted to natural sciences, but his father persuaded him to study medicine. Helmholtz was awarded a government grant to enable him to study medicine at the Royal Friedrich-Wilhelm Institute of Medicine and Surgery in Berlin. He started his studies in 1838; to get his grant he had to commit himself to work for ten years as a doctor in the Prussian army after graduating. Although he was officially studying at the Institute of Medicine and Surgery, being in Berlin, he had the opportunity of attending courses at the University. He took this opportunity and attended lectures in chemistry and physiology. Also, he studied privately the works of Laplace, Biot and Daniel Bernoulli.

Helmholtz graduated from the Medical Institute in Berlin in 1843 and was assigned to a military regiment at Potsdam. In his spare time, he did research on muscle metabolism. He published his works in the monograph *Über die Erhaltung der Kraft* (*On the Conservation of Force*), published in 1847. In his monograph he introduces the conservation of energy as a primary law of nature<sup>1</sup>:

"This law is the Law of the Conservation of Force, a term the meaning of which I must first explain. It is not absolutely new; for individual domains of natural phenomena it was enunciated by Newton and Daniel Bernoulli; and Rumford and Humphry Davy have recognized distinct features of its presence in the laws of heat.

The possibility that it was of universal application was first stated by Dr. Julius Robert Mayer, a Schwabian physician (now living in Heilbronn), in the year 1842, while almost simultaneously with, and independently of him, James Prescott Joule, an English manufacturer, made a series of important and difficult experiments on the

relation of heat to mechanical force, which supplied the chief points in which the comparison of the new theory with experience was still wanting.

The law in question asserts, that *the quantity of force which can be brought into action in the whole of Nature is unchangeable* and can neither be increased nor diminished. My first object will be to explain to you what is understood by quantity of force; or, as the same idea is more popularly expressed with reference to its technical application, what we call *amount of work* in the mechanical sense of the word.”

In 1848, Helmholtz was released from his commitment to serve in army, and he was appointed the professor of physiology in the University of Königsberg. He studied widely the physiology of senses.

Helmholtz made important contributions to the physiology of senses. He developed the ophthalmoscope; an instrument used to examine the inside of the human eye and published the book *Handbuch der Physiologischen Optik* (Handbook of Physiological Optics) in 1856. In 1863, his book *Die Lehre von den Tonempfindungen als physiologische Grundlage für die Theorie der Musik* (On the Sensations of Tone as a Physiological Basis for the Theory of Music) was published describing the sensations of tones as a physiological basis for the theory of music.

Beginning in 1874, Helmholtz held the professorship of physics at the University of Berlin, with, among others, Heinrich Hertz, Wilhem Wien, and Max Planck as his students and colleagues. In Berlin, Helmholtz’s activity was directed mainly toward electromagnetism. For example, he tried to apply the principle of the conservation of energy to Weber’s electromagnetism.

<http://www-history.mcs.st-and.ac.uk/Biographies/Helmholtz.html>

<http://www.science.uva.nl/~seop/entries/hermann-helmholtz/>

[http://en.wikipedia.org/wiki/Hermann\\_von\\_Helmholtz](http://en.wikipedia.org/wiki/Hermann_von_Helmholtz)

*On the Conservation of Force*, <http://www.bartleby.com/30/125.html>

Hermann von Helmholtz, *The Modern Development of Faraday’s Conception of Electricity* (1881),

[wikisource.org](http://wikisource.org)

Hermann von Helmholtz, e-books: [openlibrary.org](http://openlibrary.org)

## Rudolf Clausius (1822–1888)

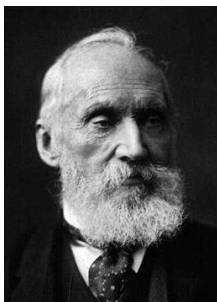

Rudolf Clausius was a German physicist and mathematician and is considered one of the central founders of the science of thermodynamics, who, for example, introduced the concept of entropy.

Clausius was born in Köslin, close to the Baltic Sea now in Poland. In 1844, Clausius graduated from the University of Berlin where he studied mathematics and physics. In 1847, he got his doctorate from the University of Halle on optical effects in the Earth’s atmosphere. In 1850, he became professor of physics at the Royal Artillery and Engineering School in Berlin and Privatdozent at the Berlin University, followed by professorships in Zurich, Würzburg, Munich, and finally in Bonn in 1869.



In his paper *Über die bewegende Kraft der Wärme (On the Moving Force of Heat and the Laws of Heat which may be Deduced Therefrom)* in 1850, Clausius's work refined the theories of Sadi Carnot and Benoît Clapeyron. Clausius defined the second principle of thermodynamics, which, fifteen years later in 1865, he reworded and complemented with the concept of *entropy*.

Clausius made major contributions to the development of the kinetic gas theory, in which he included translational, rotational and vibrational molecular motions. In this same work he introduced the concept of the *mean free path* of a particle.

Clausius collected his articles on thermodynamics in the book *The Mechanical Theory of Heat – with its Applications to the Steam Engine and to Physical Properties of Bodies* published in English in 1867.

[http://en.wikipedia.org/wiki/Rudolf\\_Clausius](http://en.wikipedia.org/wiki/Rudolf_Clausius)

<http://www-history.mcs.st-and.ac.uk/Biographies/Clausius.html>

R. Clausius, *Die mechanische Wärmetheori* (1891), [openlibrary.org](http://openlibrary.org)

R. Clausius, *Die Potentialfunktion und das Potential. Ein Beitrag zur Mathematischen Physik* (1885), [openlibrary.org](http://openlibrary.org)

*Mechanical Theory of Heat*, edited by T. Archer Hirst (1867), [openlibrary.org](http://openlibrary.org)

## William Thomson (1824–1907)

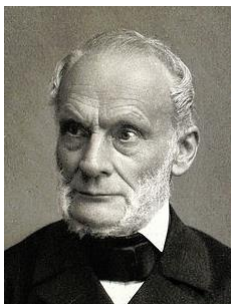

William Thomson, or Lord Kelvin, was an Irish-born British mathematical physicist and engineer, perhaps best known for the *kelvin* unit of the absolute temperature scale bearing his name.

William Thomson received his basic education from his father, who was the professor of mathematics and engineering at the Royal Belfast Academical Institution. At the age of 10, William attended Glasgow University, where he studied astronomy and chemistry complemented with natural philosophy courses including a study of heat, electricity and magnetism. He was also interested in the classics; at the age of 12 he won a prize for translating Lucian of Samosata's *Dialogues of the Gods* from Latin to English.

In the late 1830s, Thomson studied Fourier's *Théorie analytique de la chaleur (The Analytical Theory of Heat)* and committed himself to study the “continental” mathematics. In 1841, Thomson published a treatise on Fourier's series against criticism from the professor of mathematics at the University of Edinburgh. In the next year, he published the work *On the uniform motion of heat and its connection with the mathematical theory of electricity*.

In 1845, Thomson read George Green's work, *An Essay on the Application of Mathematical Analysis to the Theories of Electricity and Magnetism*, which was to have a major influence on the direction of his research. His interest in the French approach, and advice from his father, meant that after taking his degree Thomson went to Paris.

In 1845, Thomson was offered the opportunity to work in Henri-Victor Regnault's laboratory in Paris. Inspired by the French mathematician Joseph Liouville,

Thomson began to try to bring together the ideas of Faraday, Coulomb and Poisson on electrical theory. Ideas of *action at a distance* or properties of the *aether*, and ideas of an *electrical fluid* were difficult to unify.

In 1846, Thomson received the professorship of natural philosophy at the University of Glasgow. He started a long-lasting collaboration with Stokes on hydrodynamical studies, which Thomson applied to electrical and atomic theory. His interest in thermodynamics was awakened when he heard about James Joules work on the connection between heat and mechanical work. As his first reaction, Thomson questioned the mechanical equivalence of heat, but work with Joule changed his opinion. He saw that Joule's approach needed theoretical bases; as a part of his effort for the theoretical bases, he found that a gas thermometer produces the absolute temperature scale. The point of absolute zero had the meaning of a state that cannot release heat in any circumstances.

The most important contribution of Thomson may be in his efforts in combining the descriptions of heat, hydrodynamics, and electromagnetism. This was important to James Clerk Maxwell when he formulated the descriptions of electromagnetic phenomena into a unified theory.

<http://www-history.mcs.st-andrews.ac.uk/Biographies/Thomson.html>

[http://en.wikipedia.org/wiki/Lord\\_Kelvin](http://en.wikipedia.org/wiki/Lord_Kelvin)

*Lord Kelvin, an account of his scientific life and work* by Andrew Grey (1908), [openlibrary.org](http://openlibrary.org)

William Thomson, *The available energy in nature* (1881), [wikisource.org](http://wikisource.org)

William Thomson, *The Sun's Heat* (1887), [wikisource.org](http://wikisource.org)

William Thomson, *Treatise on natural philosophy* (1871), [openlibrary.org](http://openlibrary.org)

William Thomson, e-books, [openlibrary.org](http://openlibrary.org)

## George Stoney (1826–1911)

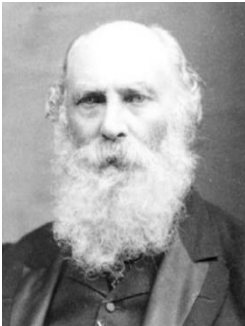

George Stoney was an Anglo-Irish physicist. He is most famous for introducing the term *electron* as the “fundamental unit quantity of electricity” in 1891.

George Stoney was born at Oakley Park, in the Irish Midlands. He attended Trinity College, Dublin, graduating in 1848. From 1848 to 1852, he worked as an astronomy assistant to William Parsons, who had built the world's largest telescope, the 72-inch Leviathan of Parsonstown. Simultaneously, Stoney continued to study physics and mathematics and received his M.A. at Trinity College Dublin in 1852,

and the professorship in physics at Queen's College Galway. From 1857 to 1882, he was employed as Secretary of the Queen's University of Ireland, an administrative job based in Dublin. He also served for decades as honorary secretary and then vice-president of the Royal Dublin Society. Besides his administrative jobs he published a large number of scientific papers.

In 1874, Stoney estimated the numerical value of the unit charge by dividing Faraday's charge with the Avogadro constant, which resulted in about  $10^{-20}$  Coulomb. (the modern value is  $1.6 \cdot 10^{-19}$  Coulomb). In 1891, he named the unit charge *electron*.

Stoney's ideas of the electron as the carrier of a unit charge gave the basis to J.J. Thomson's work on the experimental identification of the electron.

In 1881, he found *Stoney's mass*, expressed in terms of the elementary charge  $e$ , the dielectric constant  $\epsilon_0$ , and the gravitational constant  $G$ . Stoney's mass was a predecessor to Planck's mass units. Stoney's mass converts into Planck's mass  $m_{P(h)}$  ( $= m_p / \sqrt{2\pi}$ ) by multiplying  $m_s$  by the square root of the fine structure constant  $a$

$$m_s = \sqrt{\frac{e^2}{4\pi\epsilon_0 G}} = \sqrt{a} \cdot m_{P(h)}$$

Stoney's distance is

$$l_s = \sqrt{\frac{e^2}{4\pi\epsilon_0 G}} \frac{G}{c^2} = \frac{G}{c^2} m_s = r_G(m_s)$$

which is equal to the critical gravitational radius of mass  $m_s$  in the Dynamic Universe framework or half of the critical radius in Schwarzschild space.

[http://en.wikipedia.org/wiki/George\\_Johnstone\\_Stoney](http://en.wikipedia.org/wiki/George_Johnstone_Stoney)

<http://famousirishscientists.weebly.com/george-johnstone-stoney.html>

*Stoney Units*, Philosophical Magazine, vol. 11, p. 381 (1881)

George Stoney, *The story of the November Meteors* (1879), [wikisource.org](http://wikisource.org)

## James Clerk Maxwell (1831–1879)



James Clerk Maxwell was a Scottish mathematical physicist best known for *Maxwell's equations* unifying the electromagnetic theory.

James Maxwell was born in Edinburgh, in Scotland. James's mother died in 1839, and two years later, James was sent to the prestigious Edinburgh Academy. Maxwell was fascinated by geometry at an early age. At the age of 13, he won the school's mathematical medal and first prize for both English and poetry. At the age of 16, he attended classes at the University of Edinburgh. Maxwell's first year tutors included Sir William Hamilton,

who lectured him on logic and metaphysics, Philip Kelland on mathematics, and James Forbes on natural philosophy. In his free time he experimented with improvised chemical, electric, and magnetic apparatuses, but his chief concerns regarded the properties of polarized light.

In 1850, already an accomplished mathematician, Maxwell left Scotland for the University of Cambridge and soon attended Trinity College where he graduated in 1854. Maxwell remained at Trinity for two years under a fellowship that allowed him to pursue scientific interests at his own leisure.

In 1856, 25 year old Maxwell was appointed the professor of mathematics at the University of Aberdeen. There he solved the stability of Saturn's rings by postulating

that the rings are composed of small particles. Maxwell's conclusion was confirmed from the photographs taken by the Voyager spacecraft in 1980s.

Maxwell's paper *On Faraday's lines of force* was read to the Cambridge Philosophical Society in two parts, in 1855 and 1856. Maxwell showed that a few relatively simple mathematical equations could express the behavior of electric and magnetic fields and their interrelation. He refers several times to Weber's works and states, for example, that "...the velocity of transverse undulations in our hypothetical medium, calculated from the electro-magnetic experiments of MM. Kohlbrausch and Weber, agrees so exactly with the velocity of light calculated from the optical experiments of M. Fizeau, that we can scarcely avoid the inference that light consists in the transverse undulations of the same medium which is the cause of electric and magnetic phenomena".

In his treatise *A Dynamical Theory of the Electromagnetic field*, published in 1865, Maxwell presents equations that define the properties of electrostatic and electrodynamic fields and their mutual interactions. The wave equation derived from Maxwell's equations describes the propagation velocity of electromagnetic radiation in terms of the electric and magnetic constants (permittivity and permeability) confirming the prediction by Weber in 1856.

Maxwell published his famous equations in 1874 in the book *A treatise on electricity and magnetism*. The modern vector formulation of Maxwell's equations is based on divergence and curl operators developed by Oliver Heaviside. Heaviside's formulation reduced the number of equations from 15 to 4<sup>1</sup>.

<http://www-history.mcs.st-and.ac.uk/Biographies/Maxwell.html>

[http://en.wikipedia.org/wiki/James\\_Clerk\\_Maxwell](http://en.wikipedia.org/wiki/James_Clerk_Maxwell)

Links to publications: [http://en.wikisource.org/wiki/Author:James\\_Clerk\\_Maxwell](http://en.wikisource.org/wiki/Author:James_Clerk_Maxwell)

J C Maxwell, *On Faraday's Lines of Force* (1856), <http://www.scribd.com/doc/39568221/Maxwell-On-Faraday-s-Lines-of-Force>

J C Maxwell, *On the Stability of the motion of Saturn's rings* (1859), [openlibrary.org](http://openlibrary.org)

J C Maxwell, *On physical lines of force* (1861), [wikisource.org](http://wikisource.org)

J C Maxwell, *A Dynamical Theory of the Electromagnetic Field* (1864), [wikisource.org](http://wikisource.org)

J C Maxwell, *Theory of Heat* (1871), [openlibrary.org](http://openlibrary.org)

J C Maxwell, *A treatise on electricity and magnetism* (1873), [openlibrary.org](http://openlibrary.org), [wikisource.org](http://wikisource.org)

J C Maxwell, *A treatise on electricity and magnetism*, Volume I (1873)

[http://posner.library.cmu.edu/Posner/books/book.cgi?call=537\\_M46T\\_1873\\_VOL\\_1](http://posner.library.cmu.edu/Posner/books/book.cgi?call=537_M46T_1873_VOL_1)

J C Maxwell, *A treatise on electricity and magnetism*, Volume II (1873)

[http://posner.library.cmu.edu/Posner/books/book.cgi?call=537\\_M46T\\_1873\\_VOL\\_2](http://posner.library.cmu.edu/Posner/books/book.cgi?call=537_M46T_1873_VOL_2)

J C Maxwell, *The Theory of Molecules* (1874), [wikisource.org](http://wikisource.org)

J C Maxwell, *Matter and Motion* (1876), [openlibrary.org](http://openlibrary.org)

J C Maxwell, *On a Possible Mode of Detecting a Motion of the Solar System through the Luminiferous Ether* (1880), [wikisource.org](http://wikisource.org)

J C Maxwell, *An elementary treatise on electricity* (1881), [openlibrary.org](http://openlibrary.org)

*The Scientific Papers of James Clerk Maxwell* by W.D. Niven (1890), [openlibrary.org](http://openlibrary.org)

J C Maxwell, *On Faraday's lines of force* edited by WD Niven, *The scientific papers of James Clerk Maxwell* (New York, Dover, 1965) vol. 1, p. 155–229. Article originally published in 1855.

<sup>1</sup> André Waser (2000), *On the Notation of Maxwell's Field Equations* [http://www.zpenergy.com/downloads/Orig\\_maxwell\\_equations.pdf](http://www.zpenergy.com/downloads/Orig_maxwell_equations.pdf)

## Ernst Mach (1838–1916)



Ernst Mach was an Austrian physicist and philosopher, noted for his contributions to physics such as the Mach number, the “Mach’s principle” that links inertia of mass to the total mass in space, as well as writings on the history of science.

Ernst Mach was born in Chrlice, Moravia (then in the Austrian empire, now part of Brno in the Czech Republic). He started his studies in the University of Vienna. There he studied physics, receiving his doctorate in 1860.

His early work focused on the Doppler effect in optics and acoustics. In 1864, he took a job as Professor of Mathematics in Graz; two years later he was appointed Professor of Physics. In 1867, he took the chair of Experimental Physics at the Charles University, Prague, where he stayed for 28 years before returning to Vienna.

As a positivist, criticizing Newton’s mechanics, he prepared the “scientific atmosphere” for Einstein’s theory of relativity. In Mach’s metaphysics, phenomena should be expressed as simply as possible, being aware that the descriptions are not perfect.

“Machian physics” defined the properties of ideal of physical theorization:

1. *It should be based entirely on directly observable phenomena (in line with his positivistic leanings).*
2. *It should completely eschew absolute space and time in favor of relative motion.*
3. *Any phenomena that would seem attributable to absolute space and time (for example, inertia, and centrifugal force) should instead be seen as emerging from the large-scale distribution of matter in the universe.*

Ernst Mach was one of the last opponents of the atomic theory. He had long controversies with Boltzmann on the kinetic theory of gases.

[http://en.wikipedia.org/wiki/Ernst\\_Mach](http://en.wikipedia.org/wiki/Ernst_Mach)

Ernst Mach, *History and root of the principle of the conservation of energy*, English translation: Philip E.B. Jourdain (1911), [openlibrary.org](http://openlibrary.org)

Ernst Mach, *The Analysis of Sensations, and the relation of the physical to the psychological* (1914), [openlibrary.org](http://openlibrary.org)

Ernst Mach, *The Science of Mechanics, a critical and historical account of its development*, English translation:

Philip E.B. Jourdain (1915), [openlibrary.org](http://openlibrary.org)

Ernst Mach, e-books: [openlibrary.org](http://openlibrary.org)

## Josiah Willard Gibbs (1839–1903)

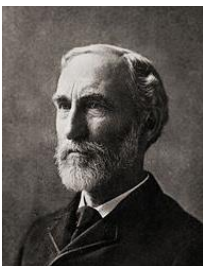

Josiah Gibbs was an American scientist who made important theoretical contributions to physics, chemistry, and mathematics.

Gibbs belonged to a long line of American academics and clergymen settled in the Boston area. In 1854, Gibbs entered Yale College showing excellence in Latin and mathematics. Gibbs began to undertake research in engineering and was awarded a

doctorate in 1863, as the first doctorate of engineering in the United States. From 1866 to 1869, Gibbs studied in Europe meeting several leading physicists, including Herman von Helmholtz.

Gibbs returned to Yale in 1869 and, two years later, he was appointed professor of mathematical physics at Yale. Gibbs most famous work *On the Equilibrium of Heterogeneous Substances* was published in the two parts in the late 1870s.

Gibbs introduced several concepts that have remained in the standard vocabulary in physical chemistry, such as *chemical potential*, *free energy*, and the *Gibb's phase rule*.

<http://www-history.mcs.st-and.ac.uk/Biographies/Gibbs.html>

[http://en.wikipedia.org/wiki/Josiah\\_Gibbs](http://en.wikipedia.org/wiki/Josiah_Gibbs)

The Scientific Papers of J. Willard Gibbs (1906), [openlibrary.org](http://openlibrary.org)

Willard Gibbs, *Elementary Principles in Statistical Mechanics* (1902), [openlibrary.org](http://openlibrary.org)

## Ludwig Boltzmann (1844-1906)



Ludwig Boltzmann was an Austrian physicist whose greatest achievement was in the development of statistical mechanics.

Boltzmann was born in Wien. He studied physics at the University of Vienna. His dissertation on the kinetic theory of gases, tutored by Joseph Stefan was completed in 1866. Boltzmann served as professor of mathematical physics at the University of Graz from 1869 to 1873, and then from 1876 to 1890, and as professor of mathematics at the University of Vienna in the interim between the two periods. From 1890 he was professor of physics at the University of Munich until he returned to Vienna in 1902.

He made his most important contributions to the development of statistical mechanics and thermodynamics during his stay in Graz, the Maxwell-Boltzmann distribution in 1871, and the thermodynamic derivation of Josef Stefan's experimental radiation law in 1879. He used the last phase of his professional career for defending his theories. Also, he gave highly popular public lectures in the University of Vienna.

Boltzmann was subject to rapid alternation of depressed moods. The criticism he received against his theory based on statistical probabilities affected him strongly – Boltzmann hanged himself during an attack of depression in 1906.

<http://www-history.mcs.st-and.ac.uk/Biographies/Boltzmann.html>

[http://en.wikipedia.org/wiki/Ludwig\\_Boltzmann](http://en.wikipedia.org/wiki/Ludwig_Boltzmann)

Ludwig Boltzmann, *Vorlesungen über Maxwells Theorie der Elektrizität und des Lichtes* (1891), [openlibrary.org](http://openlibrary.org)

Ludwig Boltzmann, *Vorlesungen über Gastheorie* (1896), [openlibrary.org](http://openlibrary.org)

## Woldemar Voigt (1850–1919)



Woldemar Voigt was a German physicist, who developed coordinate transformations between frames of reference in relative motion.

Woldemar Voigt was born in Leipzig. For his professional years he taught at the Georg August University of Göttingen.

Voigt's transformation aims at matching the observed velocity of light in frames of references in relative motion. Voigt's transformation preserves the speed of light in all frames. It be-

comes to the Lotentz transformation when multiplied by the factor  $\sqrt{1-(v/c)^2}$

[http://en.wikipedia.org/wiki/Woldemar\\_Voigt](http://en.wikipedia.org/wiki/Woldemar_Voigt)

W. Voigt, *On the Principle of Doppler* (1887),

[https://en.wikisource.org/wiki/Translation:On\\_the\\_Principle\\_of\\_Doppler](https://en.wikisource.org/wiki/Translation:On_the_Principle_of_Doppler)

W. Voigt, *Kompendium der theoretischen Physik* (1896), [openlibrary.org](https://openlibrary.org)

W. Voigt, *Die fundamentalen physikalischen Eigenschaften der Krystalle in elementarer Darstellung* (1898), [openlibrary.org](https://openlibrary.org)

W. Voigt, *Magneto- und elektrooptik* (1898), [openlibrary.org](https://openlibrary.org)

W. Voigt, *Thermodynamik* (1904), <https://ia802705.us.archive.org/34/items/thermodynamik00voiggoog/thermodynamik00voiggoog.pdf>

## Oliver Heaviside (1850–1925)



Oliver Heaviside was a self-taught English electrical engineer, mathematician, and physicist who adapted complex numbers to the study of electrical circuits, invented mathematical techniques to the solution of differential equations (later found to be equivalent to Laplace transforms), reformulated Maxwell's field equations in terms of electric and magnetic forces and energy flux, and independently co-formulated vector analysis.

In developing the vector calculus, Heaviside introduced the *rotor* and *divergence* operators. He also introduced many useful quantities adopted in electrical engineering, such as *admittance*, *conductance*, *impedance*, *inductance*, *permeability*, and *permittivity*.

In 1884, he reformed Maxwell's equations into the modern vector format, thereby reducing twelve of the original twenty equations in twenty unknowns down to the four differential equations in two unknowns which we now know as Maxwell's equations. The four re-formulated Maxwell's equations describe the nature of static and moving electric charges and magnetic dipoles, and the relationship between the two, namely electromagnetic induction.

In the late 1880s and early 1890s, Heaviside worked on the concept of electromagnetic mass. Heaviside treated this as material mass, capable of producing the same effects.

In 1891, the British Royal Society recognized Heaviside's contributions to the mathematical description of electromagnetic phenomena by naming him a Fellow of the Royal Society, and the following year devoting more than fifty pages of the *Philosophical Transactions of the Society* to his vector methods and electromagnetic theory. In 1905, Heaviside was given an honorary doctorate by the University of Göttingen.

<http://www-history.mcs.st-and.ac.uk/Biographies/Heaviside.html>

[http://en.wikipedia.org/wiki/Oliver\\_Heaviside](http://en.wikipedia.org/wiki/Oliver_Heaviside)

Oliver Heaviside, *Electromagnetic waves, the propagation of potential, and the electromagnetic effects of a moving charge* (1888), [wikisource.org](http://www.wikisource.org)

Oliver Heaviside, *On the Electromagnetic Effects due to the Motion of Electrification through a Dielectric* (1889), [wikisource.org](http://www.wikisource.org)

*Electromagnetic theory* by Oliver Heaviside (1893), [openlibrary.org](http://openlibrary.org)

*Electromagnetic waves* by Oliver Heaviside (1893), [openlibrary.org](http://openlibrary.org)

## George FitzGerald (1851–1901)



George FitzGerald was an Irish professor of “natural and experimental philosophy” (i.e., physics) at Trinity College in Dublin, Ireland, during the last quarter of the 19th century.

George FitzGerald came from Dublin, Ireland. He entered Trinity College at the age of 16. He became a Fellow of Trinity College in 1877 and spent the rest of his career at this college.

FitzGerald was one of the most active physicists studying Maxwell's equations. In 1883, inspired by Maxwell's equations, FitzGerald suggested a device for producing rapidly oscillating

electric currents to generate electromagnetic waves.

He was also the first physicist who proposed length contraction as the solution of the zero result in the Michelson–Morley experiment in 1889.

<http://www-history.mcs.st-and.ac.uk/Biographies/FitzGerald.html>

[http://en.wikipedia.org/wiki/George\\_FitzGerald](http://en.wikipedia.org/wiki/George_FitzGerald)

George FitzGerald, *The Ether and the Earth's Atmosphere* (1889), [wikisource.org](http://www.wikisource.org)

## John Henry Poynting (1852–1914)

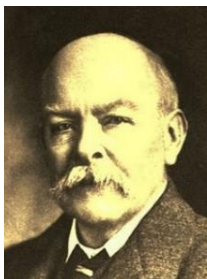

John Henry Poynting was an English physicist, who is best known for the *Poynting vector* bearing his name.

Poynting received his basic education at the school operated by his father. He continued at Owen's College, now the University of Manchester, and in the University of Cambridge. In the late 1870s, he worked in the Cavendish Laboratory at Cambridge under James Clerk Maxwell.

Henry Poynting was a professor of physics at Mason Science College (now the University of Birmingham) from 1880 until his death. He



introduced the Poynting vector, which describes the direction and magnitude of electromagnetic energy flow and is used in the Poynting theorem, a statement about energy conservation for electric and magnetic fields.

In 1893, he made measurements for determining the gravitational constant. Poynting wrote several popular textbooks covering different areas of physics.

[http://en.wikipedia.org/wiki/John\\_Henry\\_Poynting](http://en.wikipedia.org/wiki/John_Henry_Poynting)

J.H. Poynting, *On the Transfer of Energy in the Electromagnetic Field*, 1884, [wikisource.org](http://www.wikisource.org)

J.H. Poynting and J.J. Thomson, *Heat* (1909), [openlibrary.org](http://openlibrary.org)

J.H. Poynting and J.J. Thomson, *Electricity and Magnetism*, [openlibrary.org](http://openlibrary.org)

## Albert Abraham Michelson (1852–1931)



Albert Michelson was an American physicist best known for his work on the measurement of the speed of light and especially for the Michelson-Morley experiment.

Albert Michelson was born in a Jewish family in Strzelno, now in Poland. When Albert was aged two, the family moved to America, where his father was a merchant in the mining towns of Murphy's Camp, California and Virginia City, Nevada. Albert went to school in San Francisco. In 1869, he entered the U.S. Naval Academy. He studied optics, heat, climatology and drawing. After graduating in

1873, and two years at sea, he returned to the Naval Academy in 1875 to become an instructor in physics and chemistry until 1879.

In 1877, he conducted his first experiments on the speed of light. In a refined measurement in 1879, he obtained the value  $299,864 \pm 51$  km/s for the velocity of light in air, corresponding to about 299,940 km/s in a vacuum.

In 1883, Albert Michelson accepted a position as professor of physics at the Case School of Applied Science in Cleveland, Ohio, and concentrated on developing an improved interferometer. In 1887, he and Edward Morley carried out the famous Michelson-Morley experiment which seemed to rule out the existence of the aether.

In 1907, Albert Michelson had the honor of being the first American to receive a Nobel Prize in Physics. The zero result in the Michelson-Morley experiment had an important impact on Albert Einstein's postulate of the constancy of the velocity of light in the theory of relativity.

[http://en.wikipedia.org/wiki/Albert\\_Michelson](http://en.wikipedia.org/wiki/Albert_Michelson)

Experimental Determination of the Velocity of Light (1878), <https://www.gutenberg.org/files/11753/11753-h/11753-h.htm>

A.A. Michelson, *The Relative Motion of the Earth and the Luminiferous Ether* (1881), [wikisource.org](http://www.wikisource.org)

Albert A. Michelson and Edward W. Morley, *Influence of Motion of the Medium on the Velocity of Light*, *American Journal of Science*, 1886, Ser. 3, Vol. 31, Nr. 185: 377-386, [openlibrary.org](http://openlibrary.org), [wikisource.org](http://www.wikisource.org)

A.A. Michelson, E. Morley, *On the Relative Motion of the Earth and the Luminiferous Ether* (1887), [wikisource.org](http://www.wikisource.org)

A.A. Michelson, *The relative Motion of the Earth and the Ether* (1897), [wikisource.org](http://www.wikisource.org)

A.A. Michelson, *Light waves and their uses* (1903), [openlibrary.org](http://openlibrary.org)

A.A. Michelson, *Relative Motion of Earth and Aether* (1904), [wikisource.org](#)

A.A. Michelson, *Effect of Reflection from a Moving Mirror on the Velocity of Light* (1913), [wikisource.org](#)

## Hendrik Lorentz (1853–1928)

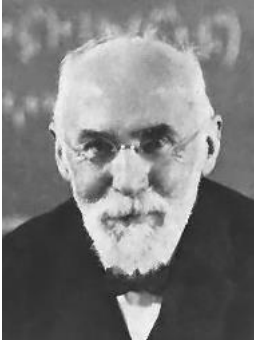

Hendrik Lorentz was a Dutch physicist who derived the transformation equations subsequently used by Albert Einstein to describe space and time.

Hendrik Lorentz was born in Arnhem, in The Netherlands. Lorentz studied physics and mathematics at the University of Leiden. In 1875, Lorentz earned a doctoral degree on a thesis entitled *Over de theorie der terugkaatsing en breking van het licht* (*On the theory of reflection and refraction of light*), in which he refined the electromagnetic theory of James Clerk Maxwell.

In 1878, Hendrik Lorentz was appointed professor of theoretical physics at the University of Leiden, the chair he kept until his retirement in 1912.

Lorentz's scientific work had started with Maxwell's equations for the thesis but gradually it covered a substantial part of physics including mechanics, thermodynamics, hydrodynamics, solid state physics, electromagnetism, and the theory of electrons. The Lorentz-force, which united the Coulomb force and the electromagnetic force, Lorentz published in 1892.

The most important work of Lorentz is the *Lorentz transformation* that, in Einstein's special theory of relativity, obtained the status of a law of nature. The paper on the *Lorentz transformation*, *De relatieve beweging van de aarde en den aether* (*The Relative Motion of the Earth and the Aether*) was published in 1892.

For explaining aberration, Fresnel had assumed that the aether does not adhere to the motion of the Earth. Stokes, on the other hand, proposed that the Earth draws the aether with it thus ensuring that the velocity of the Earth relative to the aether is zero. Lorentz was ready to reject Stokes's theory because he saw that almost all known phenomena could be explained with Fresnel's theory once the dragging coefficient is derived. It seemed that the Michelson-Morley experiment, however, required an assumption of a contraction of matter in the direction of motion. Lorentz thought about the factors determining the size and shape of a body, and concluded that the key factors come from molecular forces; whatever influences the molecular forces may affect the shape of the body. He calculated that the contraction needed for the explanation of the Michelson-Morley experiment corresponds to a contraction of the Earth about six centimeters in the direction of the orbital motion, which certainly were less than could be detected.

Lorentz called the Lorentz-transformed time *local time*. In 1900, Henri Poincaré called Lorentz's local time a "wonderful invention" and illustrated it by showing that clocks in moving frames are synchronized by exchanging light signals that are assumed to travel at the same speed against and with the motion of the frame.

Minkowski, in his interpretation of the Lorentz transformed spacetime in 1907, adopted the terms *proper time* for Lorentz's *local time*.

<http://www-history.mcs.st-and.ac.uk/Biographies/Lorentz.html>

[http://en.wikipedia.org/wiki/Hendrik\\_Lorentz](http://en.wikipedia.org/wiki/Hendrik_Lorentz)

H.A. Lorentz, *The Relative Motion of the Earth and the Aether* (1892) [https://en.wikisource.org/wiki/Translation:The\\_Relative\\_Motion\\_of\\_the\\_Earth\\_and\\_the\\_Aether](https://en.wikisource.org/wiki/Translation:The_Relative_Motion_of_the_Earth_and_the_Aether)

H.A. Lorentz, *Attempt of a Theory of Electrical and Optical Phenomena in Moving Bodies* (1895)

[https://en.wikisource.org/wiki/Translation:Attempt\\_of\\_a\\_Theory\\_of\\_Electrical\\_and\\_Optical\\_Phenomena\\_in\\_Moving\\_Bodies](https://en.wikisource.org/wiki/Translation:Attempt_of_a_Theory_of_Electrical_and_Optical_Phenomena_in_Moving_Bodies)

H.A. Lorentz, *Simplified Theory of Electrical and Optical Phenomena in Moving Systems* (1899) [wikisource.org](https://en.wikisource.org/wiki/Translation:Simplified_Theory_of_Electrical_and_Optical_Phenomena_in_Moving_Systems)

H.A. Lorentz, *Considerations on Gravitation* (1900) [wikisource.org](https://en.wikisource.org/wiki/Translation:Considerations_on_Gravitation)

H.A. Lorentz, *On the Apparent Mass of the Ions* (1900) [https://en.wikisource.org/wiki/Translation:On\\_the\\_Apparent\\_Mass\\_of\\_the\\_Ions](https://en.wikisource.org/wiki/Translation:On_the_Apparent_Mass_of_the_Ions)

H.A. Lorentz, *The theory of electrons and the propagation of light* (Nobel Lecture, 1902) [wikisource.org](https://en.wikisource.org/wiki/Translation:The_theory_of_electrons_and_the_propagation_of_light)

H.A. Lorentz, *Electromagnetic phenomena in a system moving with any velocity smaller than that of light* (1904) [wikisource.org](https://en.wikisource.org/wiki/Translation:Electromagnetic_phenomena_in_a_system_moving_with_any_velocity_smaller_than_that_of_light)

H.A. Lorentz, *The Principle of Relativity and its Application to some Special Physical Phenomena* (1910) [wikisource.org](https://en.wikisource.org/wiki/Translation:The_Principle_of_Relativity_and_its_Application_to_some_Special_Physical_Phenomena)

H.A. Lorentz, *Two Papers of Henri Poincaré on Mathematical Physics* (1914/21) [https://en.wikisource.org/wiki/Translation:Two\\_Papers\\_of\\_Henri\\_Poincar%C3%A9\\_on\\_Mathematical\\_Physics](https://en.wikisource.org/wiki/Translation:Two_Papers_of_Henri_Poincar%C3%A9_on_Mathematical_Physics)

H.A. Lorentz, *The Einstein Theory of Relativity* (1919/20), [wikisource.org](https://en.wikisource.org/wiki/Translation:The_Einstein_Theory_of_Relativity)

H.A. Lorentz, *The Michelson-Morley Experiment and the Dimensions of Moving Bodies* (1921), [wikisource.org](https://en.wikisource.org/wiki/Translation:The_Michelson-Morley_Experiment_and_the_Dimensions_of_Moving_Bodies)

## Henri Poincaré (1854–1912)



Henri Poincaré was a French mathematician, theoretical physicist, engineer, and a philosopher of science, “the last polymath and universalist”.

Poincaré was born in the Nancy area in northeastern France. In 1862, Henri entered the Lycée in Nancy; he proved to be one of the top students in every topic and a “monster of mathematics”. Poincaré entered the École Polytechnique in 1873, and graduated in 1876. He continued with engineering sciences in the École des Mines, and his doctorate in sciences in mathematics, which he completed in 1879 at the University of Paris. Since 1881, and for the rest of his career, he taught at the University of Paris. After 1893, Poincaré joined the French Bureau des Longitudes, which engaged him in the synchronization of time around the world. Poincaré presented the principle of relativity, the present formulation of the Lorentz transformation and derived the formula for the addition of velocities<sup>1,2</sup>. His motivation for the formulation of the relativity principle may have been the need for a basis for the coordinate transformation. He realized that for obtaining a straightforward theory, the velocity of light must be regarded as a natural constant. With these reservations Poincaré appreciated Lorentz's work and regarded the concept of *local time* as a “wonderful invention”. Poincaré confirmed Lorentz's conclusions about the invariance of Maxwell's equations in the Lorentz transformation.

Poincaré concluded that the conservation of the energy of electromagnetic radiation in a transformation from one frame of reference to another can be based on the

absorption of electromagnetic mass (and energy) into the aether – on the other hand he classified the aether as “a mathematical fiction”. The aether hypothesis left the conservation of momentum unsolved. Poincaré published his theory of relativity, *On the Dynamics of the Electron* in 1905, three months before the publication of Einstein’s theory of special relativity.

Poincaré stated, that we are so used to Euclidean space, that we would rather change the laws of physics than switch to non-Euclidean geometry. Poincaré based his work on a wide philosophical view and intuitive visualization; “*we prove with logic, but invent with intuition*”.

<http://www-history.mcs.st-and.ac.uk/Biographies/Poincare.html>

[http://en.wikipedia.org/wiki/Henri\\_Poincar%C3%A9](http://en.wikipedia.org/wiki/Henri_Poincar%C3%A9)

Henri Poincaré, *The Measure of Time* (1898) [wikisource.org](http://www.wikisource.org)

<sup>1</sup> H. Poincaré, *The Theory of Lorentz and the Principle of Reaction* (1900) <http://www.physicsinsights.org/poincare-1900.pdf>

Henri Poincaré, *Science and Hypothesis* (1902) [wikisource.org](http://www.wikisource.org)

<sup>2</sup> Henri Poincaré, *The Principles of Mathematical Physics* (1904) [wikisource.org](http://www.wikisource.org)

Henri Poincaré, *On the Dynamics of the Electron* (June) (1905), [wikisource.org](http://www.wikisource.org)

Henri Poincaré, *On the Dynamics of the Electron* (July) (1905/6), [wikisource.org](http://www.wikisource.org)

Henri Poincaré, *The End of Matter* (1906) [wikisource.org](http://www.wikisource.org)

Henri Poincaré, *The New Mechanics* (1908) [wikisource.org](http://www.wikisource.org)

Henri Poincaré, *The New Mechanics* (1909) [wikisource.org](http://www.wikisource.org)

Henri Poincaré, *The Value of Science: Science and Reality*, Popular Science Monthly Vol. 71, July 1907, [wikisource.org](http://www.wikisource.org)

Henri Poincaré, *Science and Hypothesis*, English translation W.J.G. (1905), [openlibrary.org](http://openlibrary.org)

Henri Poincaré, e-books, [openlibrary.org](http://openlibrary.org)

## Johannes Robert Rydberg (1854–1919),



Johannes Robert Rydberg was a Swedish physicist mainly known for the *Rydberg constant* and *Rydberg formula* that describes the wavelengths in the emission spectrum of the hydrogen atom.

Rydberg was born in Halmstad in southwestern Sweden. He received his bachelor’s degree in 1875 from the University of Lund. He continued his study of mathematics and wrote a dissertation on conic sections for his doctorate which was awarded in 1879.

He was appointed to the post of lecturer and soon to professor in mathematics at Lund; his interests were mainly in mathematical physics.

Rydberg’s most important work is on spectroscopy, where he found a relatively simple expression relating the various lines in the spectra of the elements in 1890. Rydberg’s formula got its theoretical basis first in the atomic model by Niels Bohr and later in atomic models based on quantum mechanics.

<http://www-history.mcs.st-and.ac.uk/Biographies/Rydberg.html>

[http://en.wikipedia.org/wiki/Johannes\\_Robert\\_Rydberg](http://en.wikipedia.org/wiki/Johannes_Robert_Rydberg)

## Joseph John Thomson (1856–1940)



J.J. Thomson was a British physicist credited with discovering electrons and isotopes, and inventing the mass spectrometer.

J.J. Thomson was born in 1856 in Manchester, England. He received his early education in small private schools where he showed great talent and interest in science. In 1870, he was admitted to Owens College; in 1876, he moved on to Trinity College in Cambridge. In 1884, he became Cavendish Professor of Physics. In 1906, Thomson was awarded the Nobel Prize in Physics for the discovery of the electron and for his work on the conduction of electricity in gases. Thomson was a highly gifted teacher; seven of his research assistants and his son won Nobel Prizes in physics.

Thomson discovered the electron by studying cathode rays; he recognized the electron as charged particle in 1897. In fact, he called the particles “corpuscles”, but later scientists preferred the name “electron” which had been suggested by George Stoney in 1894, prior to Thomson’s discovery.

In his treatise *On bodies smaller than atoms*, published in 1901, Thomson estimated the ratio of the mass of an electron to that of a hydrogen atom as  $1/1000$ . Together with George FitzGerald, Oliver Heaviside and George Searle, he defined the electromagnetic mass as  $m = (4/3) E/c$ . In 1900, Wilhelm Wien and Henri Poincaré defined the electromagnetic mass as  $m = E/c$ . Based on the free path of an electron in air, observed by Philipp Lenard, Thomson deduced that electron is much smaller than atom.

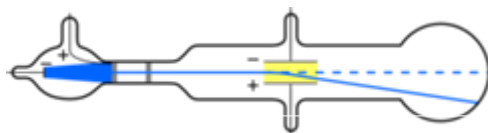

Crookes cold cathode tube used by Thomson for determining the electron mass/charge ratio.

In 1918, J.J. Thomson became Master of Trinity College, Cambridge, where he remained until his death. He died on August 30, 1940 and was buried in Westminster Abbey, close to Sir Isaac Newton.

[http://en.wikipedia.org/wiki/Joseph\\_John\\_Thomson](http://en.wikipedia.org/wiki/Joseph_John_Thomson)

J.J. Thomson, *On the Electric and Magnetic Effects produced by the Motion of Electrified Bodies* (1881), [wikisource.org](http://www.wikisource.org)

J.J. Thomson, *On the light thrown by recent investigations on Electricity on the relation between Matter and Ether* (1908), [wikisource.org](http://www.wikisource.org)

J.J. Thomson, *Rays of Positive Electricity and Their Application to Chemical Analyses* (1913), [wikisource.org](http://www.wikisource.org)

J.J. Thomson, *Romanes Lecture: The Atomic Theory*. Clarendon Press (1914), [wikisource.org](http://www.wikisource.org)

J.J. Thomson, “*On bodies smaller than atoms*”, *The Popular Science Monthly*, August 1901 pp. 323–335, <http://books.google.com/books?id=3CMDAAAAMBAJ&pg=PA323&hl=en#v=onepage&q&f=false>

## Heinrich Rudolf Hertz (1857–1894)



Heinrich Rudolf Hertz was a German physicist who succeeded in demonstrating electromagnetic waves predicted by Maxwell's equations.

Heinrich Hertz was born in Hamburg, Germany. He studied sciences and engineering in the German cities of Dresden, Munich and Berlin, where he studied under Gustav R. Kirchhoff and Hermann von Helmholtz. Hertz obtained his PhD from the University of Berlin in 1880.

In 1885, Hertz became a full professor at the University of Karlsruhe where he discovered electromagnetic waves in 1886–88. Maxwell's theory of electromagnetic waves was largely accepted after Hertz's experiments. Like Stokes, Hertz assumed local aether, which created a problem between local frames in relative motion.

In his experimentation Hertz observed that ultraviolet light improved the sensitivity of his spark gap receiver, which was later understood as the first indication of the photoelectric effect.

[http://www-history.mcs.st-and.ac.uk/Biographies/Hertz\\_Heinrich.html](http://www-history.mcs.st-and.ac.uk/Biographies/Hertz_Heinrich.html)

[http://en.wikipedia.org/wiki/Heinrich\\_Rudolf\\_Hertz](http://en.wikipedia.org/wiki/Heinrich_Rudolf_Hertz)

Heinrich Rudolf Hertz, *Electric Waves* (1893), [openlibrary.org](http://openlibrary.org)

Heinrich Rudolf Hertz, *Miscellaneous papers*: with an introd. by Philipp Lenard. Authorised English translation by D.E. Jones and G.A. Schott (1896), [openlibrary.org](http://openlibrary.org)

Heinrich Rudolf Hertz, *Principles of Mechanics*, English translation D.E. Jones (1899), [openlibrary.org](http://openlibrary.org)

## Joseph Larmor (1857–1942)



Joseph Larmor was an Irish physicist who is perhaps best known for the *Larmor frequency* in NMR spectroscopy.

Joseph Larmor lived his childhood in Belfast, Ireland. After studies at Queen's University Belfast, he went to St. John's College, Cambridge where he graduated as the top First Class student.

After teaching physics for a few years at Queen's College, Galway, he accepted a lectureship in mathematics at Cambridge in 1885. In 1903, he was appointed Lucasian Professor of Mathematics at Cambridge, a post he retained until his retirement in 1932.

Parallel to the development of Lorentz ether theory, Larmor published the Lorentz transformations in the *Philosophical Transactions of the Royal Society* in 1897, some two years before Hendrik Lorentz and eight years before Albert Einstein (1905). Also, Larmor determined the energy radiated by a charge in accelerating motion. Larmor collected his scientific works in the book *Aether and matter* published in 1900. Also, Larmor collected the works of George Stokes and William Thomson.

<http://www-history.mcs.st-and.ac.uk/Biographies/Larmor.html>

[http://en.wikipedia.org/wiki/Joseph\\_Larmor](http://en.wikipedia.org/wiki/Joseph_Larmor)

Joseph Larmor, *On a Dynamical Theory of the Electric and Luminiferous Medium, Part 3, Relations with material media* (1897, Sections 13-16) (1897) [wikisource.org](http://wikisource.org)

Joseph Larmor, *Aether and Matter* (1900, Ch. 10-11) [wikisource.org](http://wikisource.org), [openlibrary.org](http://openlibrary.org)

Joseph Larmor, *On the ascertained Absence of Effects of Motion through the Aether, in relation to the Constitution of Matter, and on the FitzGerald-Lorentz Hypothesis* (1904), [wikisource.org](http://wikisource.org)

Joseph Larmor, *Introduction to H. Poincaré's "Science and Hypothesis"* (1905), [wikisource.org](http://wikisource.org)

Joseph Larmor, *How could a Rotating Body such as the Sun become a Magnet?* (1919) in Report of the British Association for the Advancement of Science 87th Meeting, pp. 159-160, [wikisource.org](http://wikisource.org)

## Max Karl Ernst Ludwig Planck (1858–1947)

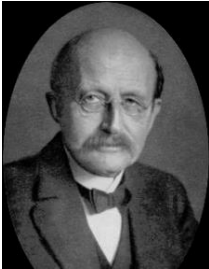

Max Planck was a German theoretical physicist who is best known for the *Planck equation*,  $E = h \cdot f$ , and the *Planck constant*,  $h$ , named after him.

Max Planck was born in Kiel, in northern Germany. In 1867, the family moved to Munich, and Planck enrolled in a gymnasium school, where he, thanks to his excellent teacher, Hermann Müller, became interested in astronomy and mechanics as well as mathematics.

In 1874, Max Planck continued his studies at the University of Munich. In 1877, he went to Berlin, having, among others, Hermann von Helmholtz and Gustav Kirchhoff as his tutors. In 1879, Planck defended his dissertation, *Über den zweiten Hauptsatz der mechanischen Wärmetheorie* (*On the second law of thermodynamics*). In 1885, he was appointed as associate professor of theoretical physics in the University of Kiel and, in 1892, professor in the University of Berlin.

Planck presented his famous equation  $E = h \cdot f$  in the seminar of Deutsche Physikalische Gesellschaft in 1900 as a part of the solution for black body radiation. The equation was based on the idea that a radiating surface comprises resonators that emit energy packets in direct proportion to the frequency. He considered the equation as an *ad hoc* finding justified by the accurate solution it gave the spectrum of black body radiation.

Max Planck was known as a man of principles who felt it important to understand the basis of the equation and its connection to classical mechanics and Maxwell's equations. This was perhaps why he did not publish scientific papers on the black body radiation for many years, nor the equation  $E = h \cdot f$ . Only after almost ten years, when the equation had been praised by several physicists, did Max Planck believe that he had made a fundamental finding in the 1900 "quantum equation".

<http://www-history.mcs.st-and.ac.uk/Biographies/Planck.html>

[http://en.wikipedia.org/wiki/Max\\_Planck](http://en.wikipedia.org/wiki/Max_Planck)

Planck's equation: Max Planck, *Entropie und Temperatur strahlender Wärme*, *Annalen der Physik* 306 (4): 719–737 (1900). See also [http://en.wikipedia.org/wiki/Planck\\_postulate](http://en.wikipedia.org/wiki/Planck_postulate)

Max Planck, *Treatise on Thermodynamics*, translated by Alexandeer Ogg (1903), [openlibrary.org](http://openlibrary.org)

Max Planck, *The Principle of Relativity and the Fundamental Equations of Mechanics* (1906) [wikisource.org](http://wikisource.org)

Max Planck, *The Measurements of Kaufmann on the Deflectability of  $\beta$ -Rays in their Importance for the Dynamics of the Electrons* (1906) [https://en.wikisource.org/wiki/Translation:The\\_Measurements\\_of\\_Kaufmann](https://en.wikisource.org/wiki/Translation:The_Measurements_of_Kaufmann)

Max Planck, *On the Dynamics of Moving Systems* (1907), [https://en.wikisource.org/wiki/Translation:On the Dynamics of Moving Systems](https://en.wikisource.org/wiki/Translation:On_the_Dynamics_of_Moving_Systems)

Max Planck, *Notes on the Principle of Action and Reaction in General Dynamics* (1908) [https://en.wikisource.org/wiki/Translation:Notes on the Principle of Action and Reaction in General Dynamics](https://en.wikisource.org/wiki/Translation:Notes_on_the_Principle_of_Action_and_Reaction_in_General_Dynamics)

Max Planck, *Das Princip der Erhaltung der Energie*, [openlibrary.org](https://openlibrary.org)

Max Planck, *Eight Lectures on Theoretical Physics* (1909) [wikisource.org](https://wikisource.org)

Max Planck, *General Dynamics. Principle of Relativity* (Lecture VIII), [wikisource.org](https://wikisource.org)

Max Planck, *Uniform Rotation and Lorentz Contraction* (1910) [https://en.wikisource.org/wiki/Translation:Uniform Rotation and Lorentz Contraction](https://en.wikisource.org/wiki/Translation:Uniform_Rotation_and_Lorentz_Contraction)

Max Planck, *The Origin and development of Quantum Theory, Nobel Prize Address, translated by H.T. Clarke and L. Silberstein* (1922), [openlibrary.org](https://openlibrary.org)

## Philipp Lenard (1862–1947)



Philipp Lenard was a Hungarian–German physicist who became known for his studies with cathode rays, essential to the explanation of the photoelectric effect.

Philipp Lenard was born in Pressburg, Kingdom of Hungary (now in Slovakia), in a German-speaking family coming from the Tyrol. He started his studies of physics and chemistry in Vienna and Budapest, continuing in Heidelberg, where he got his doctorate in 1886.

Working with Crookes cold cathode tubes, Lenard observed that ultraviolet light focused on the cathode, resulted in an electron beam in the tube. Further, he noticed that the energy of the beam was independent of the intensity of the ultraviolet light but inversely proportional to the wavelength of the light and, accordingly, directly proportional to the frequency of the ultraviolet radiation.

Lenard's work, together with Planck's equation, had an essential role in Einstein's explanation of the photoelectric effect in 1905.

[http://en.wikipedia.org/wiki/Philipp\\_Lenard](http://en.wikipedia.org/wiki/Philipp_Lenard)

P. Lenard, *Ann. d. Phys.* 8. p. 169 u. 170. 1902

Philipp Lenard, *Great men of Science, a History of Scientific Progress*. English translation H. Stafford Hatfield (1938), [archive.org](https://archive.org)

## Wilhelm Wien (1864–1928)

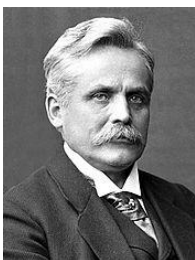

Wilhelm Wien was a German physicist best known for his works on thermal radiation.

Wilhelm Wien was born at Gaffken near Fischhausen (Rybaki), Province of Prussia (now Primorsk, Russia). After the city school of Heidelberg he, in 1882, attended the University of Göttingen and the University of Berlin. He worked in the laboratory of Hermann von Helmholtz and received his PhD in 1886. In 1900, he received a professorship at the University of Würzburg.



In 1896, Wien empirically determined a distribution law of blackbody radiation, later named after him as *Wien's law*. The work gave the basis to the solution for the black body radiation presented by Max Planck in 1900.

In his studies on ionized gas in 1898, Wien discovered a positively charged particle with the mass equal to the mass of hydrogen atom – to be later identified as the proton.

<http://www-history.mcs.st-and.ac.uk/Biographies/Wien.html>

[http://en.wikipedia.org/wiki/Wilhelm\\_Wien](http://en.wikipedia.org/wiki/Wilhelm_Wien)

Wilhelm Wien, *On the Possibility of an Electromagnetic Foundation of Mechanics* (1900), *Annalen der Physik*, 310, Nr. 7, 1901, S. 501-513, [https://en.wikisource.org/wiki/Translation:On\\_the\\_Possibility\\_of\\_an\\_Electromagnetic\\_Foundation\\_of\\_Mechanics](https://en.wikisource.org/wiki/Translation:On_the_Possibility_of_an_Electromagnetic_Foundation_of_Mechanics)

## Hermann Minkowski (1864–1909)



Hermann Minkowski was a German mathematician best known for his spacetime interpretation of relativistic picture of reality.

Hermann Minkowski was born in Lithuania (then a part of the Russian Empire). When Hermann was eight years old the family returned to Germany and settled in Königsberg, where Hermann went to the Gymnasium and then continued his studies at the University of Königsberg in 1880 receiving his doctorate in 1885.

In 1908, Minkowski became known for his space-time interpretation, describing time as the fourth dimension orthogonal to the three space directions. Spacetime became a generally accepted concept as a description of the Einsteinian picture of reality.

<http://www-history.mcs.st-and.ac.uk/Biographies/Minkowski.html>

[http://en.wikipedia.org/wiki/Hermann\\_Minkowski](http://en.wikipedia.org/wiki/Hermann_Minkowski)

Hermann Minkowski, *The Fundamental Equations for Electromagnetic Processes in Moving Bodies*, *Nachrichten von der Gesellschaft der Wissenschaften zu Göttingen, Mathematisch-Physikalische Klasse*, pp. 53–111, Presented in the session of December 21, 1907 [https://en.wikisource.org/wiki/Translation:The\\_Fundamental\\_Equations\\_for\\_Electromagnetic\\_Processes\\_in\\_Moving\\_Bodies](https://en.wikisource.org/wiki/Translation:The_Fundamental_Equations_for_Electromagnetic_Processes_in_Moving_Bodies)

Hermann Minkowski, *Space and Time*, (Raum und Zeit 1909) *Jahresberichte der Deutschen Mathematiker-Vereinigung*, 1-14, B.G. Teubner [wikisource.org](https://en.wikisource.org/wiki/Space_and_Time)

## Robert Millikan (1868–1953)



Robert Millikan was an American experimental physicist, who is best known for his measurement of the charge on the electron and for his work on the photoelectric effect.

Millikan went to high school in Maquoketa, Iowa. He received his doctorate in physics from Columbia University in 1895. After a professorship at the University of Chicago, he served as Chair of the Executive Council at Caltech from 1921 to 1945.

In 1908, while a professor at the University of Chicago, Millikan worked on an oil-drop experiment in which he measured the charge on a single electron.

J.J. Thomson had already discovered the charge-to-mass ratio of the electron in 1906, and shown that the hydrogen atom has only one electron. However, the actual charge and mass values were unknown. Millikan used the oil-drop experiment to measure the charge of the electron. Millikan's result was  $1.592 \cdot 10^{-19}$  coulomb (CODATA 2006 value for unit charge is  $1.602\,176\,53 \cdot 10^{-19}$  C). Millikan's result was important for the semi-classical model of hydrogen atom presented by Niels Bohr in 1913.

Millikan undertook a decade-long experimental program to test Einstein's theory of the photoelectric effect. He was not convinced of Einstein's interpretation of the photoelectric effect, and as late as in 1916 he wrote "*Einstein's photoelectric equation ... cannot in my judgment be looked upon at present as resting upon any sort of a satisfactory theoretical foundation, even though 'it actually represents very accurately the behavior' of the photoelectric effect*". In his 1950, autobiography, however, he declared that his work "*scarcely permits of any other interpretation than that which Einstein had originally suggested, namely that of the semi-corpuseular or photon theory of light itself*".

[http://en.wikipedia.org/wiki/Robert\\_Millikan](http://en.wikipedia.org/wiki/Robert_Millikan)

Robert A. Millikan, *On the Elementary Electrical Charge and the Avogadro Constant*, Phys.Rev. Vol II, Series II (1913), <http://www.aip.org/history/gap/PDF/millikan.pdf>

Robert Millikan, *The Electron* (1917), [openlibrary.org](http://openlibrary.org)

Robert A. Millikan and Henry G. Gale, *A first Course in Physics* (1906), [openlibrary.org](http://openlibrary.org)

## Arnold Sommerfeld (1868–1951)



Arnold Sommerfeld was a German theoretical physicist who pioneered developments in atomic and quantum physics. Sommerfeld is also known for introducing the fine structure constant.

Sommerfeld studied mathematics and physical sciences at the Albertina University of his native city, Königsberg, East Prussia (now Kaliningrad, Russia).

His career as physicist started at the University of Göttingen, where he was the successor of Wilhelm Wien as the professor of mathematics. In 1900, he received a professorship in Aachen but moved to the University of Munich in 1906, where he served as the director of the new Theoretical Physics Institute for more than 30 years. Four of his students went on to win Nobel prizes, and many others became famous in their own right.

Sommerfeld developed a generalized version of Bohr's atomic model by complementing the circular orbits in Bohr's model, with elliptic orbits. The model applied a relativistic solution and resulted in the same predictions as Dirac's equation in 1928. Sommerfeld's atomic model was one of the last developments in the "old quantum theory".

<http://www-history.mcs.st-and.ac.uk/Biographies/Sommerfeld.html>

[http://en.wikipedia.org/wiki/Arnold\\_Sommerfeld](http://en.wikipedia.org/wiki/Arnold_Sommerfeld)  
[http://en.wikipedia.org/wiki/Bohr%E2%80%93Sommerfeld\\_theory](http://en.wikipedia.org/wiki/Bohr%E2%80%93Sommerfeld_theory)  
[http://en.wikipedia.org/wiki/BKS\\_theory](http://en.wikipedia.org/wiki/BKS_theory)

Arnold Sommerfeld, *An Objection Against the Theory of Relativity of Electrodynamics and its Removal*, *Physikalische Zeitschrift* 8 (23): 841-842 (1907) [https://en.wikisource.org/wiki/Translation:An\\_Objection\\_Against\\_the\\_Theory\\_of\\_Relativity\\_and\\_its\\_Removal](https://en.wikisource.org/wiki/Translation:An_Objection_Against_the_Theory_of_Relativity_and_its_Removal)

Arnold Sommerfeld, *On the Composition of Velocities in the Theory of Relativity*, *Verh. der DPG*, 1909, 21: 577-582 (1909) [https://en.wikisource.org/wiki/Translation:On\\_the\\_Composition\\_of\\_Velocities\\_in\\_the\\_Theory\\_of\\_Relativity](https://en.wikisource.org/wiki/Translation:On_the_Composition_of_Velocities_in_the_Theory_of_Relativity)

Arnold Sommerfeld, *On the Theory of Relativity I: Four-dimensional Vector Algebra* (1910), [https://en.wikisource.org/wiki/Translation:On\\_the\\_Theory\\_of\\_Relativity\\_I:\\_Four-dimensional\\_Vector\\_Algebra](https://en.wikisource.org/wiki/Translation:On_the_Theory_of_Relativity_I:_Four-dimensional_Vector_Algebra)

Arnold Sommerfeld, *On the Theory of Relativity II: Four-dimensional Vector Analysis* (1910), [https://en.wikisource.org/wiki/Translation:On\\_the\\_Theory\\_of\\_Relativity\\_II:\\_Four-dimensional\\_Vector\\_Analysis](https://en.wikisource.org/wiki/Translation:On_the_Theory_of_Relativity_II:_Four-dimensional_Vector_Analysis)

Arnold Sommerfeld, *Atombau und Spektrallinien* (1921), [openlibrary.org](https://openlibrary.org)

## Ernest Rutherford (1871–1937)



Ernest Rutherford, born in New Zealand, was a British chemist and physicist who became known as the father of nuclear physics.

Rutherford made several fundamental findings in his experiments with radioactive phenomena in the early 1900s. He named the alpha- and beta-radiation and also the gamma-radiation discovered by Paul Villard. The gold foil experiment he did together with Hans Geiger and Ernest Marsden in 1909, indicated that the tiny positively charged nucleus of an atom is surrounded by a cloud of electrons with negative charge. Rutherford was tutored by Joseph John Thomson. Rutherford published his atomic model in 1911. The idea of an atom as a structure with a nucleus surrounded by electrically charged particles was first presented by the English polymath Richard Laming (1798–1879).

[http://en.wikipedia.org/wiki/Ernest\\_Rutherford](http://en.wikipedia.org/wiki/Ernest_Rutherford)

Ernest Rutherford, *Radioactivity* (1904), [openlibrary.org](https://openlibrary.org)

Ernest Rutherford, *Radioactive substances and their radiations* (1913), [openlibrary.org](https://openlibrary.org)

## Walter Kaufmann (1871–1947)

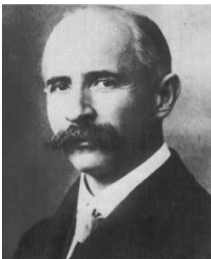

Walter Kaufmann was a German physicist. He is best known for his first experimental proof of the velocity dependence of mass, which was an important contribution to the development of modern physics, including special relativity.

From 1880, Walter Kaufmann had studied mechanical engineering and physics in Berlin and Munich, attaining his doctorate in 1894. Starting from 1896, he worked as an assistant at the physical institutes of the Universities of Berlin and Göttingen. In 1899, Kaufmann became a professor of physics at the University of Bonn. After

a short period at the Berliner Physikalisches Institut he was called to the Albertina in Königsberg, as professor ordinarius for experimental physics and leader of the physical institute. There he taught until his retirement in 1935.

[http://en.wikipedia.org/wiki/Walter\\_Kaufmann\\_%28physicist%29](http://en.wikipedia.org/wiki/Walter_Kaufmann_%28physicist%29)

W. Kaufmann, *Die elektromagnetische Masse des Elektrons*, *Physikalische Zeitschrift*, 4 (1b): 54-57 (1902),

[http://experimentum-crucis.narod.ru/olderfiles/1/Elektromagnetische\\_Masse.pdf](http://experimentum-crucis.narod.ru/olderfiles/1/Elektromagnetische_Masse.pdf)

W. Kaufmann, *The Electromagnetic Mass of the Electron*, *Physikalische Zeitschrift*, 4 (1b): 54-57 (1902),

[https://en.wikisource.org/wiki/Translation:The\\_Electromagnetic\\_Mass\\_of\\_the\\_Electron](https://en.wikisource.org/wiki/Translation:The_Electromagnetic_Mass_of_the_Electron)

W. Kaufmann, *On the Constitution of the Electron*, *Sitzungsberichte der Königlich Preussischen Akademie der Wissenschaften*. 45: 949-956 (1905), [https://en.wikisource.org/wiki/Translation:On\\_the\\_Constitution\\_of\\_the\\_Electron\\_\(1905\)](https://en.wikisource.org/wiki/Translation:On_the_Constitution_of_the_Electron_(1905))

W. Kaufmann, *On the Constitution of the Electron*, *Annalen der Physik*, 324 (3): 487-553 (1906),

[https://en.wikisource.org/wiki/Translation:On\\_the\\_Constitution\\_of\\_the\\_Electron\\_\(1906\)](https://en.wikisource.org/wiki/Translation:On_the_Constitution_of_the_Electron_(1906))

## Willem de Sitter (1872–1934)

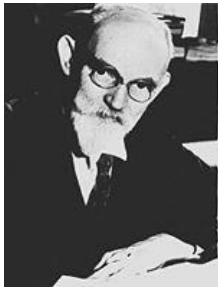

Willem de Sitter was a Dutch mathematician, physicist and astronomer. He is best known for his work at Albert Einstein college on the development of the cosmological models based on the general theory of relativity.

After graduating from Arnhem Gymnasium in the Netherlands, Willem de Sitter entered the University of Groningen with the intention of taking a mathematics degree. He received a Bachelor's Degree in 1897, and left for Cape Town to work at the Cape Observatory in South Africa for two years, taking part in photometric and heliometer programs. After de Sitter returned to Groningen in 1899, he was appointed as an assistant in the Astronomical Laboratory. In 1908, de Sitter was appointed to the chair of astronomy at Leiden University. He was director of the Leiden Observatory from 1919 until his death.

Willem de Sitter was one of the first astronomers who became acquainted with Albert Einstein's general theory of relativity. In fact, de Sitter had contemplated the possibility of 4-dimensional spacetime. In 1916-17, he published papers on the cosmological aspects of Einstein's theory, and presented a solution to the field equations for empty space.

In 1932, Einstein and de Sitter introduced the *Einstein-de Sitter* model, describing space as expanding and conserving the balance of gravitational energy and kinetic energy.

In addition to his activity on relativistic cosmology, de Sitter continued his studies on Jupiter's moons and astronomical constants, work he had started in the early 1900s.

<http://www-history.mcs.st-and.ac.uk/Biographies/Sitter.html>

[http://en.wikipedia.org/wiki/Willem\\_de\\_Sitter](http://en.wikipedia.org/wiki/Willem_de_Sitter)

Willem de Sitter, *On the bearing of the Principle of Relativity on Gravitational Astronomy* (1911), [wikisource.org](http://wikisource.org)

Willem de Sitter, *A proof of the constancy of the velocity of light* (1913) [wikisource.org](http://wikisource.org)

Willem de Sitter, *On the constancy of the velocity of light* (1913), [wikisource.org](http://wikisource.org)

Willem de Sitter, *On Einstein's Theory of Gravitation, and its Astronomical Consequences*, Monthly Notices of the Royal Astronomical Society, **76**, 699–728 (1916), <http://articles.adsabs.harvard.edu/full/1916MNRAS..76..699D>

Willem de Sitter, *On Einstein's Theory of Gravitation, and its Astronomical Consequences*, Monthly Notices of the Royal Astronomical Society, **77**, 155–184 (1916), <http://articles.adsabs.harvard.edu/full/1916MNRAS..77..155D>

Willem de Sitter, *On Einstein's Theory of Gravitation, and its Astronomical Consequences*, Monthly Notices of the Royal Astronomical Society, **78**, 3–28 (1917), <http://articles.adsabs.harvard.edu/full/1917MNRAS..78....3D>

Willem de Sitter, *On the magnitudes, diameters and distances of the extragalactic nebulae, and their apparent radial velocities*, (B.A.N.) **5**, No. 185, 157–171 (1930)

Willem de Sitter, *The expanding universe. Discussion of Lemaître's solution of the equations of the inertial field*, (B.A.N.) **5**, No. 193, 211–218 (1930)

W. de Sitter, *Do the galaxies expand with the universe?*, (B.A.N.) **6**, No. 233, 146 (1931)

W. de Sitter, *The Size of the Universe*, *PASP*, **44**, No. 258, 89–104 (1932)

A. Einstein, W. de Sitter *On the Relation between the Expansion and the Mean Density of the Universe*, *PNAS* **18**, 213–214 (1932)

W. de Sitter, *On distance, magnitude, and related quantities in an expanding universe*, *B.A.N.*, **7**, No 261, 205 (1934)

## Karl Schwarzschild (1873–1916)



Karl Schwarzschild was a German physicist, best known for providing the first exact solution to the Einstein field equations of general relativity, for a single spherical non-rotating mass in 1915, the year that Einstein first introduced general relativity.

Schwarzschild was born in Frankfurt am Main to Jewish parents. He attended a Jewish primary school and continued in the Gymnasium at the age of 11. He had two papers on binary orbits (celestial mechanics) published while in the Gymnasium. He studied at Strasbourg and Munich, obtaining his doctorate in 1896 for work on Henri Poincaré's theories.

Schwarzschild's solution of the field equations of general relativity produced the concept of the black hole and the related critical radius. When solving the field equations Schwarzschild was serving in the German army at the Russian front. Schwarzschild died in 1916, aged 42, from a rare and painful skin disease called pemphigus just about a year after solving the field equations.

<http://www-history.mcs.st-and.ac.uk/Biographies/Schwarzschild.html>

[http://en.wikipedia.org/wiki/Karl\\_Schwarzschild](http://en.wikipedia.org/wiki/Karl_Schwarzschild)

Karl Schwarzschild, *On the Gravitational Field of a Mass Point According to Einstein's Theory*, Sitzungsberichte der Königlich Preussischen Akademie der Wissenschaften, S. 831–839 (1915),

<http://zelmanov.ptep-online.com/papers/zj-2008-03.pdf>

## Albert Einstein (1879–1955)

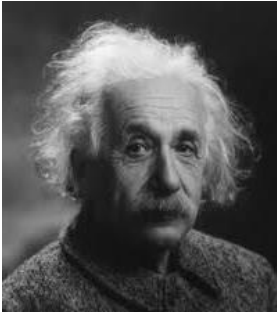

Albert Einstein was a German-born theoretical physicist who developed the special and general theories of relativity, which brought about a revolution in physics.

Albert Einstein was born in 1879 in Ulm, in southern Germany. Soon after his birth, the family moved to Munich, where his father and his uncle founded a company that manufactured electrical equipment based on direct current. An indication to Einstein's early interest in natural sciences, was an essay *On the Investigation of the State of the Ether in a Magnetic Field*, which he wrote at the age of sixteen, after a very modest education in physics. Most probably, the essay had been inspired by August Föppl's book *Theorie der Elektrizität* that Einstein had read. The book discussed Maxwell's theory and Hertz's experiments, and included a chapter on relative and absolute motion, and electrodynamics in moving systems.

In 1896, Einstein entered the Swiss Federal Polytechnic in Zurich and was awarded the teaching diploma in 1900. After graduating, Einstein searched for a teaching post, but he finally ended up as an assistant examiner in the Federal Office for Intellectual Property, the patent office in Bern. While in Bern, Einstein started a small discussion group, self-mockingly named *The Olympia Academy*, which met regularly to discuss science and philosophy, such as the works of Henri Poincaré, Ernst Mach, and David Hume. Also, he prepared his dissertation *A New Determination of Molecular Dimensions*, which was accepted in the University of Zurich in 1905.

The year 1905 became his "miracle year", during which he published four groundbreaking papers: *On a Heuristic Point of View about the Creation and Conversion of Light*, discussing the interpretation of Planck's equation for explaining the photoelectric effect; *On the Motion – Required by the Molecular Kinetic Theory of Heat – of Small Particles Suspended in a Stationary Liquid*, discussing the kinetic theory of gases and the Brownian motion; *On the Electrodynamics of Moving Bodies*, introducing the special theory of relativity; and *Does the Inertia of a Body Depend Upon Its Energy Content?*, discussing the relationship between mass and energy, and the basis of the equation  $E=mc^2$  from the point of view of the special theory of relativity.

Supported by Max Planck, Einstein gained academic recognition and was appointed lecturer at the University of Bern in 1908, and to the position of physics docent at the University of Zurich. The next step in his academic career was full professorship at the Karl-Ferdinand University in Prague in 1911. Einstein returned to Germany in 1914, and he was appointed director of the Kaiser Wilhelm Institute for Physics (1914–1932) and a professor at the Humboldt University of Berlin.

Besides his academic duties, Einstein had started to consider the generalization of the special theory of relativity into a theory covering accelerating motion and gravitation. For linking the inertial and gravitational accelerations, he postulated the equivalence principle, which, in fact already was a part of Newtonian mechanics. The non-linear acceleration in special relativity and the related increase of the "relativistic" mass was an additional attribute of the classical principle of relativity – it

meant, that the gravitational mass is also increased by motion, as in free fall in a gravitational field.

In articles published in 1907 and 1908, Einstein concluded that free fall in gravitational field is equivalent to inertial motion in special relativity. Further, he concluded that the time dilation predicted by special relativity is also present in a gravitational state corresponding to the velocity obtained in free fall due to the to the gravitational state, and that the propagation path of light is bent when passing a mass center.

The formulation of the general theory of relativity turned out to be very challenging. Einstein had to rely on his friend Marcel Grossmann, who was able to apply the tensor calculus by Tullio Levi-Civita and Gregorio Ricci-Curbastro. After many attempts, the general theory of relativity was ready for publication in 1915, and it was published in 1916 in *Annalen der Physik* under the title *Die Grundlage der allgemeinen Relativitätstheorie* (*The Foundation of the General Theory of Relativity*<sup>1</sup>). In *Kosmologische Betrachtungen zur allgemeinen Relativitätstheorie* (*Kosmological Considerations on the General Theory of Relativity*) published in 1917, Einstein discusses the cosmological appearance of space as deduced from the general theory of relativity.

The eclipse of the Sun in 1919 in South Africa offered an opportunity to test the bending of light predicted by the general theory of relativity. Observations by the English astronomer Artur Eddington showed, perhaps marginally, that the bending of light followed the prediction of general relativity. The result was announced in a visible way; the London *Times* had the headline: *Revolution in science - New theory of the Universe - Newtonian ideas overthrown*.

The London *Times* publication idolizing Einstein was certainly exaggerated. The scientific community was hesitant both regarding Eddington's observations and the general theory of relativity. The cautious attitude of the scientific community was reflected in the Nobel Prize of 1921. The Prize was granted to Einstein, not for relativity but for his 1905 work on the photoelectric effect.

Einstein's work was mainly done outside scientific institutes, principally based on modest scientific work by Einstein himself. Einstein's strength is exhibited in his ability to see the essence of the problem and in combining the elements available for solutions.

The theory of relativity, both special relativity and general relativity are based on such unprejudiced and revolutionary ideas that a thorough, critical analysis of the bases may have complicated or risked the implementation of the theory. Critical study has continued to our days, although the predictions of the theory have been confirmed in countless experiments. Anyway, both the special and the general theory of relativity have attained a wide consensus in the scientific community.

<http://www-history.mcs.st-and.ac.uk/Biographies/Einstein.html>

[http://en.wikipedia.org/wiki/Albert\\_Einstein](http://en.wikipedia.org/wiki/Albert_Einstein)

A. Einstein, *On the Electrodynamics of Moving Bodies*, *Annalen der Physik* **322** (10): 891–921. (Received June 30, 1905; published September 26, 1905), [wikisource.org](http://www.fourmilab.ch/etexts/einstein/specrel/specrel.pdf), <http://www.fourmilab.ch/etexts/einstein/specrel/specrel.pdf>

A. Einstein, *On a Heuristic Point of View about the Creation and Conversion of Light* (1905) [https://en.wikisource.org/wiki/Translation:On a Heuristic Point of View about the Creation and Conversion of Light](https://en.wikisource.org/wiki/Translation:On_a_Heuristic_Point_of_View_about_the_Creation_and_Conversion_of_Light)

- A. Einstein, *The Development of Our Views on the Composition and Essence of Radiation* (1909) [https://en.wikisource.org/wiki/Translation:The Development of Our Views on the Composition and Essence of Radiation](https://en.wikisource.org/wiki/Translation:The_Development_of_Our_Views_on_the_Composition_and_Essence_of_Radiation)
- Albert Einstein, *The Field Equations of Gravitation*, Preussische Akademie der Wissenschaften, Sitzungsberichte, 1915 (part 2), 844–847, [archive.org](https://archive.org), [https://en.wikisource.org/wiki/Translation:The Field Equations of Gravitation](https://en.wikisource.org/wiki/Translation:The_Field_Equations_of_Gravitation)
- <sup>1</sup> A. Einstein, *Die Grundlage der allgemeinen Relativitätstheorie*, Annalen der Physik 354 (7), 769–822 (1916), [http://www.physik.uni-augsburg.de/annalen/history/einstein-papers/1916\\_49\\_769-822.pdf](http://www.physik.uni-augsburg.de/annalen/history/einstein-papers/1916_49_769-822.pdf), English translation, *The Foundation of the Generalised Theory of Relativity* (1916), [wikisource.org](https://en.wikisource.org)
- A. Einstein, *Relativity: The Special and General Theory* (1916), [wikisource.org](https://en.wikisource.org)
- A. Einstein, *Kosmologische Betrachtungen zur allgemeinen Relativitätstheorie* [http://articles.adsabs.harvard.edu/cgi-bin/get\\_file?pdfs/SPAW.1917/1917SPAW.....142E.pdf](http://articles.adsabs.harvard.edu/cgi-bin/get_file?pdfs/SPAW.1917/1917SPAW.....142E.pdf) (1917)
- A. Einstein, *Dialog about Objections against the Theory of Relativity*, Die Naturwissenschaften, 29 November 1918, [https://en.wikisource.org/wiki/Translation:Dialog about Objections against the Theory of Relativity](https://en.wikisource.org/wiki/Translation:Dialog_about_Objections_against_the_Theory_of_Relativity)
- A. Einstein, *Ether and the Theory of Relativity* (1920), [wikisource.org](https://en.wikisource.org)
- B. Harrow, *From Newton to Einstein* by (1920), [openlibrary.org](https://openlibrary.org)
- M.N. Saha and S.N. Bose, *The Principle of Relativity, Original papers by A. Einstein and H. Minkowski* (1920), [openlibrary.org](https://openlibrary.org)
- A. Einstein, *A Brief Outline of the Development of the Theory of Relativity* (1921), [wikisource.org](https://en.wikisource.org)
- C. Nordmann, *Einstein and the Universe, A popular Exposition of the famous Theory* (1922), [openlibrary.org](https://openlibrary.org)

## Richard Tolman (1881–1948)



Richard Tolman was an American mathematical physicist and physical chemist who was an authority on statistical mechanics. Tolman is perhaps best known for his work on the development of cosmological predictions based on the general theory of relativity.

Richard Tolman was born in West Newton, Massachusetts. He studied chemical engineering at the Massachusetts Institute of Technology, receiving his PhD in 1910.

Tolman was a wide-ranging theoretician, who developed statistical mechanics based on the “old quantum mechanics” pioneered by Max Planck, Niels Bohr, and Arnold Sommerfeld. In the late 1910s, he verified experimentally that electric current in metal is due to the motion of electrons.

Tolman started work on the cosmological consequences of the general theory of relativity shortly after the completion of the theory. In the 1930s, he analyzed the spherically closed space proposed by Einstein in 1917. Based on Friedman’s solution of expanding space, he derived expressions for the angular diameter distance and the luminosity distance still in use in the Friedman-Lemaître-Robertson-Walker (FLRW) cosmology<sup>1</sup>. The “Tolman test” is a prediction, according to which the surface brightness decreases in proportion to the fourth power of the redshift.

In his article *Two Methods of Investigating the Nature of the Nebular Redshift*<sup>2</sup>, Tolman derives expressions for the redshift in terms of angular size, and in terms of the brightness of objects. Also, he defines the correction to be made on observations due to different factors like the sensitivity of a photographic plate at different wavelengths.



[http://en.wikipedia.org/wiki/Richard\\_Tolman](http://en.wikipedia.org/wiki/Richard_Tolman)

Richard Tolman, *The Principle of Relativity, and Non-Newtonian Mechanics* (1909) [wikisource.org](http://www.wikisource.org)

Richard Tolman, *The Second Postulate of Relativity* (1910), [wikisource.org](http://www.wikisource.org)

Richard Tolman, *Note on the Derivation from the Principle of Relativity of the Fifth Fundamental Equation of the Maxwell-*

*Lorentz Theory* (1910), [wikisource.org](http://www.wikisource.org)

Richard Tolman, *Non-Newtonian Mechanics. The Direction of Force and Acceleration* (1911), [wikisource.org](http://www.wikisource.org)

Richard Tolman, *Non-Newtonian Mechanics. The Mass of a Moving Body* (1911), [wikisource.org](http://www.wikisource.org)

Richard Tolman, *Non-Newtonian Mechanics. Some Transformation Equations* (1912)

Richard Tolman, *Some Emission Theories of Light* (1912), [wikisource.org](http://www.wikisource.org)

Richard Tolman, *The Electromotive Force Produced by the Acceleration of Metals* (1916)

<http://www.pnas.org/content/2/3/189.full.pdf+html>

Richard Tolman, *The Mass of the Electric Carrier in Copper, Silver and Aluminium* (1917),

<http://www.pnas.org/content/3/1/58.full.pdf+html>

Richard Tolman, *On the Nature of Light* (1927), <http://www.pnas.org/content/12/5/343.full.pdf+html>

<http://www.pnas.org/content/12/5/343.full.pdf+html>

Richard Tolman, *On the Energy and Entropy of Einstein's Closed Universe* (1928)

<http://www.pnas.org/content/14/4/348.full.pdf+html>

Richard Tolman, *On the Possible Line Elements for the Universe* (1929) <http://www.pnas.org/content/15/4/297.full.pdf+html>

<http://www.pnas.org/content/15/4/297.full.pdf+html>

"On the Astronomical Implications of the de Sitter Line Element for the Universe", *The Astrophysical Journal*,

69, 245–274 (1929), [http://adsabs.harvard.edu/cgi-bin/nph-data\\_query?bibcode=1929ApJ....69..245T&db\\_key=AST&link\\_type=ARTICLE](http://adsabs.harvard.edu/cgi-bin/nph-data_query?bibcode=1929ApJ....69..245T&db_key=AST&link_type=ARTICLE)

[http://adsabs.harvard.edu/cgi-bin/nph-data\\_query?bibcode=1929ApJ....69..245T&db\\_key=AST&link\\_type=ARTICLE](http://adsabs.harvard.edu/cgi-bin/nph-data_query?bibcode=1929ApJ....69..245T&db_key=AST&link_type=ARTICLE)

<sup>1</sup> Richard Tolman, *On the Estimation of Distances in a Curved Universe with a Non-Static Line Element*, *PNAS*

16, 511–520 (1930), <http://www.pnas.org/content/16/7/511.full.pdf+html>

<sup>2</sup> Richard Tolman, *Two Methods of Investigating the Nature of the Nebular Redshift*, *ApJ* 82, 302–337 (1935).

## Max Born (1882–1970)



Max Born was a German-British physicist and mathematician who is best known for the matrix mechanics he formulated together with Werner Heisenberg.

Max Born was born in Breslau (now Wrocław, Poland), which at Born's birth was in the Prussian Province of Silesia in the German Empire. After getting his early education at the König-Wilhelm-Gymnasium, Born went on to study at the University of Breslau, then at Heidelberg University and the University of

Zurich. During study for his PhD and Habilitation at the University of Göttingen, he came into contact with many prominent scientists and mathematicians including Klein, Hilbert, Minkowski, Runge, Schwarzschild, and Voigt.

<http://www-history.mcs.st-and.ac.uk/Biographies/Born.html>

[http://en.wikipedia.org/wiki/Max\\_Born](http://en.wikipedia.org/wiki/Max_Born)

Max Born, *Einstein's theory of Relativity* (1920), [openlibrary.org](http://openlibrary.org)

Max Born, *Zur Quantenmechanik der Stoßvorgänge*, *Zeitschrift für Physik* 37 (12): 863–867 (1926)

Max Born, *The statistical interpretation of quantum mechanics* (1954), [http://www.nobelprize.org/nobel\\_prizes/physics/laureates/1954/born-lecture.pdf](http://www.nobelprize.org/nobel_prizes/physics/laureates/1954/born-lecture.pdf)

[http://www.nobelprize.org/nobel\\_prizes/physics/laureates/1954/born-lecture.pdf](http://www.nobelprize.org/nobel_prizes/physics/laureates/1954/born-lecture.pdf)

Mehra, *Historical Development of Quantum Theory. Volume 3, The Formulation of Matrix Mechanics and Its Modifications* 1925–1926

## Niels Henrik David Bohr (1885–1962)



Niels Bohr was a Danish physicist who made fundamental contributions to understanding atomic structure and quantum mechanics.

Bohr was born in Copenhagen. Starting in 1903, Bohr got his scientific training at Copenhagen University, receiving his doctorate in 1911. As a post-doctoral student, Bohr first conducted experiments under J. J. Thomson, of Trinity College, Cambridge and the Cavendish Laboratory. In 1912, he met and later joined Ernest Rutherford at Manchester University.

Bohr developed his model for the hydrogen atom when working in Manchester with Ernest Rutherford, who had presented a “planet model” of atom. Based on Max Planck’s and Albert Einstein’s quantum hypotheses, Bohr deduced that the structure of the atom is based on discrete energy states of electrons.

Bohr’s first model of the hydrogen atom, published in 1913, combined Planck’s “quantum of action” with classical mechanics. He postulated that stable electron orbits have angular momentums that are integer multiples of the reduced Planck constant  $\hbar = h/2\pi$ . Bohr found that the energy differences between stable electron orbits were energies that, interpreted with Planck’s equation, gave the emission wavelengths that corresponded to the experimental formula introduced by Johannes Rydberg in 1890. Bohr’s atomic model had an important impact on the development of quantum mechanics.

[http://www-history.mcs.st-andrews.ac.uk/Biographies/Bohr\\_Niels.html](http://www-history.mcs.st-andrews.ac.uk/Biographies/Bohr_Niels.html)

[http://en.wikipedia.org/wiki/Niels\\_Henrik\\_David\\_Bohr](http://en.wikipedia.org/wiki/Niels_Henrik_David_Bohr)

Niels Bohr, *On the quantum theory of line-spectra* (1918), [openlibrary.org](http://openlibrary.org)

## Erwin Schrödinger (1887–1961)



Erwin Schrödinger was an Austrian physicist who is best known for the Schrödinger equation that formed a cornerstone of quantum mechanics.

Schrödinger was born in Vienna. He graduated from the Akademisches Gymnasium in 1906, entered the University of Vienna in 1907, and was awarded his doctorate in 1910. He was appointed to an assistantship at Vienna in experimental physics. Schrödinger’s first important paper, in 1914, discussed the statistical mechanics of Boltzmann. In 1921, Schrödinger was appointed the professor of theoretical physics in Zurich where he focused on atomic structure and quantum statistics. In 1927, he succeeded Max Planck at the Friedrich Wilhelm University in Berlin. The famous Schrödinger equation<sup>1</sup>, published in 1926, was inspired by de Broglie’s work. Schrödinger left Germany in 1933 and lectured in several universities.

<sup>1</sup> E Schrödinger, *Quantisierung als Eigenwertproblem*, [Annalen der Physik](http://www.annalen-der-physik.de/vol385/issue13/pp437-490), vol. 385, Issue 13, pp.437-490

<http://www-history.mcs.st-and.ac.uk/Biographies/Schrodinger.html>  
<http://en.wikipedia.org/wiki/Schr%C3%B6dinger>

## Alexander Friedmann (1888–1925)



Alexander Friedmann was a Russian physicist and mathematician, who is best known for his “expanding space” solutions of the field equations of general relativity in 1922.

Alexander Friedmann was born in St. Petersburg and got his scientific education at St. Petersburg State University. In 1918, he obtained a professorship in Perm State University.

Friedman’s solution of the field equations allowed curved space, with either positive or negative curvature or zero curvature. It contains solutions for both stationary and non-stationary space. His paper *Über die Krümmung des Raumes*<sup>1</sup> (*On the curvature of space*) introducing the solution, was published in 1922. In his paper he stated that the stationary solution is possible only in the two cases that Einstein and de Sitter already had analyzed. However, there are several solutions for non-stationary space “...cases, in which the radius of curvature increases continuously, and cases, in which the radius of curvature changes periodically ...”.

In his paper *Über die Möglichkeit einer Welt mit konstanter negativer Krümmung des Raumes*<sup>2</sup> (*On the Possibility of a World, Where the Curvature of Space is Constant and Negative*). Friedmann made detailed analyses on negative, positive, and zero curvatures of space.

<sup>1</sup> A. Friedmann, *Über die Krümmung des Raumes*, *Zeitschrift für Physik* 10 (1), 377–386 (1922)

<sup>2</sup> A. Friedmann, *Zeitschrift für Physik* 21 (1): 326–332 (1924)

<http://www-history.mcs.st-and.ac.uk/Biographies/Friedmann.html>  
[http://en.wikipedia.org/wiki/Alexander\\_Friedmann](http://en.wikipedia.org/wiki/Alexander_Friedmann)

## Edwin Powell Hubble (1889–1953)



The American astronomer Edwin Hubble is best known for his observations of the redshift of distant celestial objects, and *Hubble’s law* describing the connection between distance and the redshift.

Hubble was born in Marshfield, Missouri, and moved to Wheaton, Illinois, in 1900. He studied mathematics, astronomy, and philosophy at the University of Chicago and received his Bachelor of science degree in 1910. He entered Queen’s College, Oxford in England for three years. After a year of high-school teaching in Albany, New York, he returned to astronomy at the Yerkes Observatory of the University of Chicago, where he received his PhD in 1917. His dissertation was entitled *Photographic Investigations of Faint Nebulae*.

From 1919, Hubble worked with the world's largest, 2.5 m, telescope at Mount Wilson in California. He was able to confirm that space extends far beyond the Milky Way and is inhabited by a countless number of galaxies and nebulae beyond the Milky Way. His observations, published in 1929, showed a clear correlation between the distance and the redshift of the light from the objects. Together with Milton Humason, Hubble interpreted the redshifts as Doppler effects – the objects receded at a velocity proportional to their distance. In their analyses they also used the earlier redshift observations made by the American astronomer Vesto Slipher, who together with his colleagues James Keeler and William Campbell had realized the distance dependence of the redshift and interpreted it as the Doppler effect in 1917.

<http://www-history.mcs.st-and.ac.uk/Biographies/Hubble.html>

Edwin Hubble, *Photographic investigations of faint nebulae* (1920), [openlibrary.org](http://openlibrary.org)

E. Hubble and M. Humason, *The Velocity-Distance Relation among Extra-Galactic Nebulae*, [\*Astrophys.J.\* \*\*74\*\*, 43 \(1931\)](#)

E. Hubble and R. C. Tolman, *Two Methods of Investigating the Nature of the Nebular Redshift*, [\*AJ\*, \*\*82\*\*, 302 \(1935\)](#)

E. Hubble, *Effects of Red Shifts on the Distribution of Nebulae*, [\*Astrophys. J.\* \*\*84\*\*, 517 \(1936\)](#)

## Louis de Broglie (1892–1987)



Louis de Broglie was a French physicist, who is best known for the *de Broglie* wavelength named after him.

Louis de Broglie was born in Dieppe, Seine-Maritime, in northern France. De Broglie had intended a career in humanities and received his first degree in history. Afterwards, he turned his attention towards mathematics and physics and received a degree in physics in 1913 before serving in the army in World War I. He continued his studies with focus on theoretical physics in 1920.

de Broglie aimed at generalizing the idea of the wave nature of the atom manifested by Bohr's atomic model. In his dissertation in 1924, he introduced the idea that a mass particle moving in space can be described as a wave. The momentum of such a wave, as shown by the Planck's equation, should equal to the classical momentum of the particle, which gave the de Broglie wavelength.

de Broglie's wave hypothesis was confirmed in the experiments carried out by the American physicists Clinton Davisson and Lester Germer in 1927. In the Davisson–Germer experiment an electron beam was directed to a nickel surface at different angles. The reflected beam showed an interference pattern that corresponded exactly to the interference pattern created by waves with de Broglie wavelength reflected from nickel lattice.

The de Broglie wavelength applies to the description of electrons or to any other mass object with momentum in space. de Broglie did not agree with the idea of a mass wave independent of the velocity of the object, because he understood a particle as a localized object.

<http://www-history.mcs.st-and.ac.uk/Biographies/Broglie.html>

[http://en.wikipedia.org/wiki/Louis\\_de\\_Broglie](http://en.wikipedia.org/wiki/Louis_de_Broglie)

Louis de Broglie, *Waves and Quanta*, Nature, Volume 112, Issue 2815, pp. 540 (1923)

Louis de Broglie, *Interference and Corpuscular Light*, Nature, Volume 118, Issue 2969, pp. 441-442 (1926)

## Arthur Compton (1892–1962)

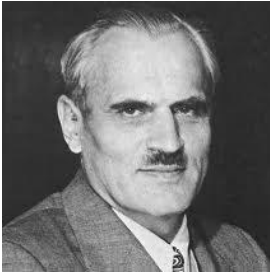

Arthur Compton was an American physicist, who is best known for *Compton-scattering* and the *Compton wavelength* named after him. Compton's work was a major contribution to the development of quantum mechanics.

Arthur Compton was born in Wooster, Ohio. He obtained his PhD at Princeton University in 1916. After employment at the University of Minnesota, the Westinghouse Lamp Company, and the University of Cambridge, Compton returned to Washington University in St. Louis, where he served as Head of the Department of Physics from 1920 to 1923. He became the university's ninth Chancellor in 1946.

In 1922, while on the faculty at Washington University in St. Louis Compton found that X-ray wavelengths increase due to scattering of the radiant energy emitted by "free electrons". The scattered quanta have less energy than the quanta of the original ray. This discovery, known as the *Compton effect* or *Compton scattering* is interpreted as the *particle* concept of electromagnetic radiation and earned Compton the Nobel Prize in physics in 1927.

Compton discovered a method, based on X-rays, for the determination of the number of electrons in an atom. In 1930–1940, he supervised an international research project related to the properties of cosmic rays. In 1941, Compton gained support for consolidating plutonium research at the University of Chicago and for an ambitious schedule that called for producing the first atomic bomb.

[http://en.wikipedia.org/wiki/Arthur\\_Compton](http://en.wikipedia.org/wiki/Arthur_Compton)

## Georges Lemaître (1894–1966)



Georges Lemaître was a Belgian priest, astronomer and professor of physics at the Catholic University of Louvain. He was the first person to propose the theory of the expanding Universe started from a singularity.

Georges Lemaître began studying civil engineering at the Catholic University of Louvain in 1911. After the war he studied physics and mathematics and obtained his doctorate in 1920. In 1923, he became a graduate student in astronomy at the University of Cambridge, working with Arthur Eddington who initiated him into modern cosmology, stellar astronomy, and numerical analysis.

Starting from Einstein's static spherically closed space, he presented a model of an expanding space that was consistent with the field equations of general relativity and explained the Hubble law. The treatise was published under the title *Un Univers homogène de masse constante et de rayon croissant rendant compte de la vitesse radiale des nébuleuses extragalactiques* (*A homogeneous Universe of constant mass and growing radius accounting for the radial velocity of extragalactic nebulae*) in *Annals of the Scientific Society of Brussels*<sup>1</sup> in 1927.

In his paper *L'Univers en expansion, (On the Expanding Universe)*<sup>2</sup>, in 1933, he presents an inhomogeneous solution of the field equations, known as Lemaître–Tolman metrics.

Lemaître continued his scientific work until the 1960s. Among other things, he studied the use of Gauss's methods on the solutions of planetary orbits based on three observations.

<http://www-history.mcs.st-andrews.ac.uk/Biographies/Lemaitre.html>

[http://en.wikipedia.org/wiki/Georges\\_Lema%C3%AAtre](http://en.wikipedia.org/wiki/Georges_Lema%C3%AAtre)

<sup>1</sup> Georges Lemaître, *Annals of the Scientific Society of Brussels*, 47, 49–59 (1927)

Georges Lemaître, *Expansion of the universe, The expanding universe*, *MNRAS* 91, 490L (1931)

<sup>2</sup> Georges Lemaître, *L'Univers en expansion*, 1933 Ann. Soc. Sci. Bruxelles, A53, 51 (1933)

## Werner Heisenberg (1901–1976)



Werner Heisenberg was a German theoretical physicist and philosopher who discovered a way to formulate quantum mechanics in terms of matrices in 1925. He is best known for *Heisenberg's uncertainty principle* bearing his name.

Werner Heisenberg was born in Würzburg, Germany. He studied physics and mathematics from 1920 to 1923 at the Ludwig-Maximilians-Universität München. Heisenberg was tutored by Arnold Sommerfeld and Wilhelm Wien. After graduation he returned to his hometown Göttingen, where he, together with Max Born and Pascual Jordan developed the formalism of matrix mechanics. In 1926, Heisenberg was appointed lecturer and the assistant of Niels Bohr in Copenhagen, where he formulated the uncertainty principle. In 1927, he was appointed professor of theoretical physics at the University of Leipzig. In the late 1920s, Heisenberg together with Wolfgang Pauli developed the basis of relativistic field theory. In the early 1930s, he published his work on neutron-proton model that brought him the Nobel Prize.

<http://www-history.mcs.st-and.ac.uk/Biographies/Heisenberg.html>

[http://en.wikipedia.org/wiki/Werner\\_Heisenberg](http://en.wikipedia.org/wiki/Werner_Heisenberg)

W. Heisenberg, *Über quantentheoretische Umdeutung kinematischer und mechanischer Beziehungen*, *Zeitschrift für Physik*, September 1925

## Paul Dirac (1902–1984)



Paul Dirac was an English theoretical physicist who made fundamental contributions to the early development of both quantum mechanics and quantum electrodynamics.

Paul Adrien Maurice Dirac was born in Bristol, England. Dirac was educated first at Bishop Road Primary School and then at the all-boys Merchant Venturers' Technical College and at University of Bristol. He was awarded a PhD in 1926 at the University of Cambridge. He went to Copenhagen to work with Niels Bohr, moving on, in 1927, to Göttingen where he interacted with Robert Oppenheimer and Max Born. Dirac was appointed Lucasian professor of mathematics at the University of Cambridge in 1932, a post he held for 37 years. In 1971, Dirac was appointed professor of physics at Florida State University where he continued his research.

Dirac created a formalism of quantum mechanics that was consistent with Hamilton's mechanics. His *Dirac's equation* (1928) is a description of the wave function of the electron in the framework of special relativity. The work led, for example, to the prediction of the positron as the anti-particle to the electron, and of the spin  $\frac{1}{2}$  for the electron. Dirac shared the Nobel Prize in Physics in 1933 with Erwin Schrödinger, "for the discovery of new productive forms of atomic theory".

<http://www-history.mcs.st-and.ac.uk/Biographies/Dirac.html>

[http://en.wikipedia.org/wiki/Paul\\_Dirac](http://en.wikipedia.org/wiki/Paul_Dirac)

## Howard Robertson (1903–1961)



Howard Robertson was an American mathematician and physicist known for contributions related to physical cosmology and the uncertainty principle. He is perhaps best known for his contribution to the *Friedman-Lemaître-Robertson-Walker (FLRW)* cosmology.

Robertson was born in Hoquiam, Washington, and earned a master's degree in mathematics and physics in 1923 from the University of Washington in Seattle. He completed his PhD at Caltech in mathematics and physics in 1925, with the dissertation, *On Dynamical Space-Times Which Contain a Conformal Euclidean 3-Space*.

Based on the general theory of relativity, Robertson developed a model for double stars orbiting each other. The model did not include gravitational radiation or any other deceleration mechanisms, thus predicting stable orbits.

H.P. Robertson, *On the Foundations of Relativistic Cosmology*, [PNAS 15, 822 \(1929\)](#)

H.P. Robertson, *The apparent luminosity of a receding nebula*, [Zs.f.Ap. 15, 69 \(1938\)](#)

H.P. Robertson, *On the Foundations of Relativistic Cosmology*, [PASP 67, 82 \(1955\)](#)

## George Gamov (1904–1968)



George Gamov was a Ukrainian-born theoretical physicist and cosmologist, and an early developer of Lemaitre's Big Bang theory. He is best known for his work on nucleosynthesis and the prediction of the cosmic microwave background radiation.

Gamov was born in Odessa in Russia (now in Ukraine). He started his studies in the Novorossiia University in Odessa and continued at the University of Leningrad in 1923 under the tutorship of Alexander Friedmann. He prepared his dissertation on quantum theory in Göttingen, and moved to the University of Copenhagen in 1928, and back to Leningrad in 1931.

Gamov fled from the Soviet Union when participating the Solvay conference in Brussels in 1933. He moved to the United States in 1934, and received a professorship at George Washington University, Washington D.C. He was granted US citizenship in 1940.

In the 1940s, his work was directed to astrophysics and cosmology; among other things, he developed theories on the formation of stars and the solar system. His best-known work is on nucleosynthesis in Big Bang cosmology. Also, he predicted that the cosmic background radiation is a highly redshifted afterglow of the Big Bang. Cosmic Microwave Radiation, corresponding to Gamov's prediction, was detected in 1964 by the American radar engineers Arno Penzias and Robert Wilson.

[http://en.wikipedia.org/wiki/George\\_Gamov](http://en.wikipedia.org/wiki/George_Gamov)

## Arthur Geoffrey Walker (1909–2001)



Arthur Walker was an English mathematician who is best known for his important contribution to the *Friedman-Lemaître-Robertson-Walker* (FLRW) cosmology.

Walker was an accomplished geometer, but he is best remembered today for two important contributions to general relativity: In collaboration with H. P. Robertson, he developed the well-known Robertson-Walker metric for the Friedmann-Lemaître-Robertson-Walker cosmological model, which is an exact solution of the Einstein field equation. Together with Enrico Fermi, he developed the notion of Fermi-Walker differentiation.

[http://en.wikipedia.org/wiki/Arthur\\_Geoffrey\\_Walker](http://en.wikipedia.org/wiki/Arthur_Geoffrey_Walker)

A.G. Walker, *Distance in an Expanding Universe*, [MNRAS 94, 159 \(1933\)](#)

A.G. Walker, *Formal Comparison of Milne's model*, [MNRAS 95, 263 \(1935\)](#)



## David Bohm (1917–1992)



David Bohm was an American-British quantum physicist who contributed to theoretical physics, philosophy of mind, and neuropsychology.

David Bohm was born in Pennsylvania, United States, and attended Pennsylvania State College (now The Pennsylvania State University), graduating in 1939, after which he attended the California Institute of Technology for a year. He then transferred to the theoretical physics group directed by Robert Oppenheimer at the University of California, Berkeley, where he eventually obtained his doctoral degree.

Due to suspicions of Communism during the McCarthy era, he left the US, eventually becoming a British citizen.

David Bohm was looking for a holistic picture of reality consistent with quantum mechanical phenomena. He introduced the concepts of *Implicate Order*, in which a system exists in a non-observable state, and *Explicate Order*, showing the material form and the observable reality. Bohm's theory is referred to as a pilot wave theory, as an extension of de Broglie's hidden variable theory.

[http://en.wikipedia.org/wiki/David\\_Bohm](http://en.wikipedia.org/wiki/David_Bohm)

## Richard Feynman (1918–1988)



Richard Feynman was an American theoretical physicist known for his work in the path integral formulation of quantum mechanics, the theory of quantum electrodynamics, and the physics of the superfluidity of supercooled liquid helium, as well as his work in particle physics.

Richard Feynman was born in Queens, New York. He received a PhD from Princeton in 1942. After that he participated in the Manhattan project in Los Alamos. From 1950, he worked as a professor of physics at the California Institute of Technology.

Before this he lectured in theoretical physics at Cornell University for the five years following the end of the second World War.

Feynman was known as an excellent lecturer who tried to make physics understandable, in his lectures he, however, admitted that "*quantum mechanics cannot be understood*".

Many of his lectures and miscellaneous talks have been published as books, including *The Character of Physical Law*, *QED: The Strange Theory of Light and Matter*, *Statistical Mechanics*, *Lectures on Gravitation*, and *the Feynman Lectures on Computation*. Feynman later won the Ørsted Medal for teaching, of which he seemed to be especially proud.

[http://en.wikipedia.org/wiki/Richard\\_Feynman](http://en.wikipedia.org/wiki/Richard_Feynman)





PHYSICS FOUNDATIONS SOCIETY  
[www.physicsfoundations.org](http://www.physicsfoundations.org)



THE FINNISH SOCIETY FOR  
NATURAL PHILOSOPHY  
[www.lfs.fi](http://www.lfs.fi)

Dr. Suntola's "The Short History of Science" shows fascinating competence in its constructively critical in-depth exploration of the long path that the pioneers of metaphysics and empirical science have followed in building up our present understanding of physical reality. The book is made unique by the author's perspective. He reflects the historical path to his Dynamic Universe theory that opens an unparalleled perspective to a deeper understanding of the harmony in nature – to click the pieces of the puzzle into their places. The book opens a unique possibility for the reader to make his own evaluation of the postulates behind our present understanding of reality. – *Tarja Kallio-Tamminen, PhD, theoretical philosophy, MSc, high energy physics*

The book gives an exceptionally interesting perspective on the history of science and the development paths that have led to our scientific picture of physical reality. As a philosophical question, the reader may conclude how much the development has been directed by coincidences, and whether the picture of reality would have been different if another path had been chosen. – *Heikki Sipilä, PhD, nuclear physics*

Would other routes have been chosen, if all modern experiments had been available to the early scientists? This is an excellent book for a guided scientific tour challenging the reader to an in-depth consideration of the choices made. – *Ari Lehto, PhD, physics*



**Tuomo Suntola**, PhD in Electron Physics at Helsinki University of Technology (1971). Dr. Suntola has a far-reaching academic and industrial career comprising pioneering work from fundamental theoretical findings to successful applications like the *Atomic Layer Deposition* method, a key technology in the semiconductor industry.

*"Nature is built on a few fundamental principles of conservation and harmony which, at a philosophical level, were discovered by the thinkers of antiquity. This book is a search for these same principles behind present theories and the related picture of physical reality".*

ISBN 978-952-68101-6-4 (hardcover)

ISBN 978-952-68101-7-1 (PDF)